



This is a digital copy of a book that was preserved for generations on library shelves before it was carefully scanned by Google as part of a project to make the world's books discoverable online.

It has survived long enough for the copyright to expire and the book to enter the public domain. A public domain book is one that was never subject to copyright or whose legal copyright term has expired. Whether a book is in the public domain may vary country to country. Public domain books are our gateways to the past, representing a wealth of history, culture and knowledge that's often difficult to discover.

Marks, notations and other marginalia present in the original volume will appear in this file - a reminder of this book's long journey from the publisher to a library and finally to you.

### **Usage guidelines**

Google is proud to partner with libraries to digitize public domain materials and make them widely accessible. Public domain books belong to the public and we are merely their custodians. Nevertheless, this work is expensive, so in order to keep providing this resource, we have taken steps to prevent abuse by commercial parties, including placing technical restrictions on automated querying.

We also ask that you:

- + *Make non-commercial use of the files* We designed Google Book Search for use by individuals, and we request that you use these files for personal, non-commercial purposes.
- + *Refrain from automated querying* Do not send automated queries of any sort to Google's system: If you are conducting research on machine translation, optical character recognition or other areas where access to a large amount of text is helpful, please contact us. We encourage the use of public domain materials for these purposes and may be able to help.
- + *Maintain attribution* The Google "watermark" you see on each file is essential for informing people about this project and helping them find additional materials through Google Book Search. Please do not remove it.
- + *Keep it legal* Whatever your use, remember that you are responsible for ensuring that what you are doing is legal. Do not assume that just because we believe a book is in the public domain for users in the United States, that the work is also in the public domain for users in other countries. Whether a book is still in copyright varies from country to country, and we can't offer guidance on whether any specific use of any specific book is allowed. Please do not assume that a book's appearance in Google Book Search means it can be used in any manner anywhere in the world. Copyright infringement liability can be quite severe.

### **About Google Book Search**

Google's mission is to organize the world's information and to make it universally accessible and useful. Google Book Search helps readers discover the world's books while helping authors and publishers reach new audiences. You can search through the full text of this book on the web at <http://books.google.com/>

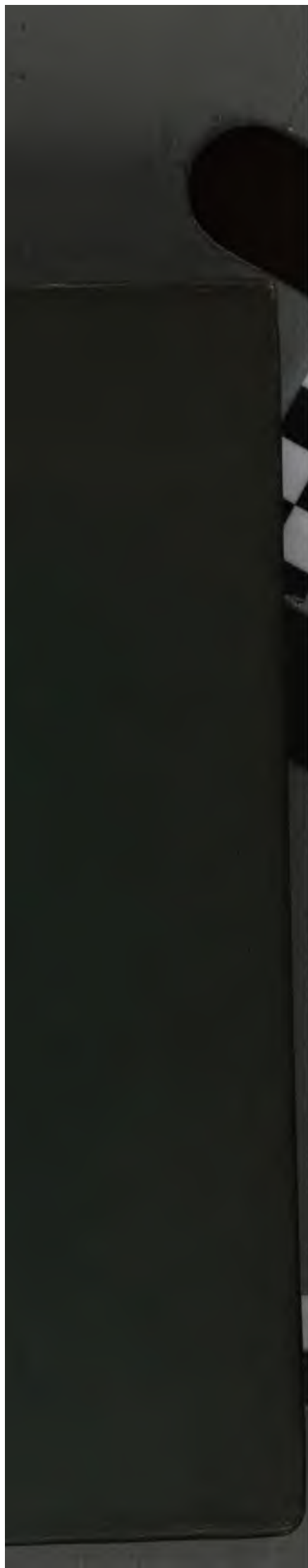



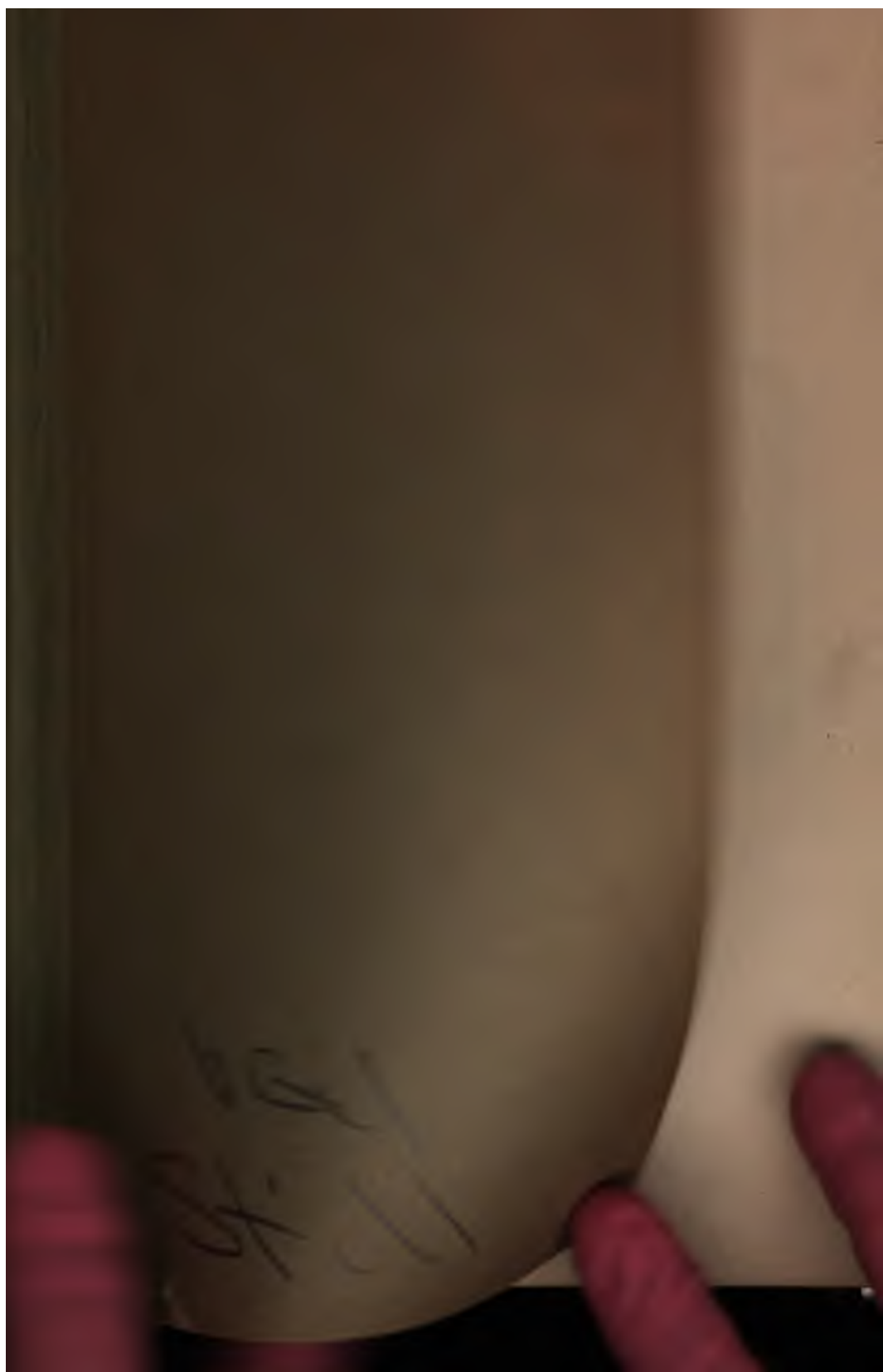









**PRINCIPLES OF  
ELECTRICAL DESIGN**

# McGraw-Hill Book Company

*Publishers of Books for*

Electrical World      The Engineering and Mining Journal

Engineering Record      Engineering News

Railway Age Gazette      American Machinist

Signal Engineer      American Engineer

Electric Railway Journal      Coal Age

Metallurgical and Chemical Engineering      Power

PRINCIPLES  
OF  
ELECTRICAL DESIGN

D. C. AND A. C. GENERATORS

BY

ALFRED <sup>D. C.</sup> STILL

PROFESSOR OF ELECTRICAL DESIGN, PURDUE UNIVERSITY; FELLOW AMERICAN INSTITUTE  
OF ELECTRICAL ENGINEERS; MEMBER INSTITUTION OF CIVIL ENGINEERS; MEMBER  
INSTITUTION OF ELECTRICAL ENGINEERS. AUTHOR OF "OVERHEAD ELECTRIC  
POWER TRANSMISSION," "POLYPHASE CURRENTS," ETC.

FIRST EDITION

McGRAW-HILL BOOK COMPANY, Inc.

239 WEST 39TH STREET. NEW YORK

LONDON: HILL PUBLISHING CO., LTD.

6 & 8 BOUVERIE ST., E. C.

1916

THE NEW YORK  
PUBLIC LIBRARY  
**738350**  
ASTOR, LENOX AND  
TILDEN FOUNDATIONS  
R 1916 L

COPYRIGHT, 1916, BY THE  
MCGRAW-HILL BOOK COMPANY, INC.

NOV 21 1916  
1857  
YEARS

THE MAPLE PRESS YORK PA

## PREFACE

This book is intended mainly for the use of students following courses in Electrical Engineering, and for this reason emphasis is laid on fundamentals and principles of general application, while but little attention is paid to the needs of the practical designer, who may be trusted to devise his own time-saving methods of calculation, provided always that he has a thorough understanding of the essentials governing all electrical design:

The writer is a firm believer in the advantage of having a concrete mental conception of the hidden actions which produce visible or measurable results, and in studying the electromotive forces developed in the windings of electric generators, he consistently represents the effects as being due to the cutting by the conductors of imaginary magnetic lines.

No attempt has been made to deal adequately with the mechanical principles involved in the design of electrical machinery. Thus as a reference book for the designer, this text is admittedly incomplete. It is incomplete also as a means of giving the student what he is supposed to get from a course in electrical design, for the simple reason that no art can be mastered by the mere reading of a book. In this as in every other study, all that is worth having the student must himself acquire by giving his mind to the business on hand and taking pains. The book cannot do more than serve as a reference text or the basis for a course of lectures; and for every hour of book study, four to six hours should be spent in the actual working out of practical designs.

The writer has ventured to express some views regarding the qualifications of the successful designer in an introductory chapter where he believes they are less likely to remain permanently buried than if embodied in a preface of unconventional length. At the same time he does not claim that the procedure here adopted is such as will meet the requirements of the professional designer; but in criticising the book, it is important to bear in mind that its main object is to illustrate the logical application of known fundamental principles, and so help the reader to realize the practical value of theoretical knowledge. It is not to



be supposed for a moment that an experienced designer can afford the time required to work through the detailed design sheets as here given in connection with the numerical examples; but, apart from the fact that he generally makes use of existing patterns and stampings, in connection with which he has at hand a vast amount of accumulated data, he is in a position to apply short-cut methods to his work. This is not readily done by the student, who usually lacks the experience, judgment, and sense of proportion, without which "rule of thumb" methods and rough approximations cannot be applied intelligently.

Portions of the material here presented have appeared recently in articles and papers contributed by the writer to the "*Electrical World*," the *Journal of the Franklin Institute*, and the *Journal of the Institution of Electrical Engineers*; but what has been borrowed from these publications has to a large extent been rewritten.

The thanks of the writer are also due to Mr. D. L. Curtner, not only for assistance in reading and correcting proofs; but also for valuable suggestions and helpful criticism.

LAFAYETTE, IND.,  
June, 1916.

# CONTENTS

PREFACE . . . . .	v
LIST OF SYMBOLS . . . . .	xi

## CHAPTER I

INTRODUCTORY . . . . .	1
------------------------	---

## CHAPTER II

### THE MAGNETIC CIRCUIT—ELECTROMAGNETS

ART.	PAGE
1. The magnetic circuit . . . . .	10
2. Definitions . . . . .	12
3. Effect of iron in the magnetic circuit . . . . .	15
4. Magnetic circuits in parallel . . . . .	18
5. Calculation of leakage paths . . . . .	22
6. Flux leakage in similar designs . . . . .	27
7. Leakage coefficient . . . . .	28
8. Tractive force . . . . .	29
9. Materials—Wire and insulation . . . . .	32
10. Calculation of magnet windings . . . . .	41
11. Heat dissipation—Temperature rise . . . . .	44
12. Intermittent heating . . . . .	46

## CHAPTER III

### THE DESIGN OF ELECTROMAGNETS

13. Introductory . . . . .	48
14. Short stroke tractive magnet . . . . .	49
15. Magnetic clutch . . . . .	50
16. Horseshoe lifting magnet (Numerical example) . . . . .	53
17. Circular lifting magnet (Numerical example) . . . . .	64

## CONTINUOUS CURRENT GENERATORS

### CHAPTER IV

#### DYNAMO DESIGN—FUNDAMENTAL CONSIDERATIONS—BRIEF OUTLINE OF PROBLEM

18. Generation of e.m.f. . . . .	70
19. The output formula . . . . .	72
20. Number of poles—Pole pitch—Frequency . . . . .	78

## CONTENTS

## CHAPTER V

## ARMATURE WINDINGS AND SLOT INSULATION

ART.	PAGE
21. Introductory . . . . .	83
22. Ring- and drum-wound armatures . . . . .	84
23. Multiple and series windings . . . . .	84
24. Equalizing connections for multiple-wound armatures . . . . .	90
25. Insulation of armature windings . . . . .	91
26. Number of teeth on armature . . . . .	93
27. Number of commutator segments—Potential difference between segments . . . . .	93
28. Nature and thickness of slot insulation . . . . .	94
29. Current density in armature conductors . . . . .	96
30. Length and resistance of armature winding . . . . .	97

## CHAPTER VI

## LOSSES IN ARMATURES—VENTILATION—TEMPERATURE RISE

31. Hysteresis and eddy-current losses in armature stampings . . . . .	100
32. Usual densities and losses in armature cores . . . . .	104
33. Ventilation of armatures . . . . .	105
34. Cooling surfaces and temperature rise of armature . . . . .	107
35. Summary, and syllabus of following chapters . . . . .	113

## CHAPTER VII

## FLUX DISTRIBUTION OVER ARMATURE SURFACE

36. Air-gap flux distribution with toothed armatures . . . . .	115
37. Actual tooth density in terms of air-gap density . . . . .	119
38. Correction for taper of tooth . . . . .	121
39. Variation of permeance over pole pitch—Permeance curve . . . . .	123
40. Open-circuit flux distribution and m.m.f. curves . . . . .	128
41. Practical method of predetermining flux distribution . . . . .	129
42. Open-circuit flux distribution curves as influenced by tooth saturation . . . . .	132
43. Effect of armature current in modifying flux distribution . . . . .	135

## CHAPTER VIII

## COMMUTATION

44. Introductory . . . . .	140
45. Theory of commutation . . . . .	142
46. Effect of slot flux . . . . .	149
47. Effect of end flux . . . . .	151
48. Calculation of end flux . . . . .	155
49. Calculation of slot flux cut by coil during commutation . . . . .	160
50. Commutating interpoles . . . . .	165
51. Example of interpole design . . . . .	171

## CONTENTS

ix

Art.	Page
52. Prevention of sparking—Practical considerations . . . . .	175
53. Mechanical details affecting commutation . . . . .	178
54. Heating of commutator—Temperature rise . . . . .	181

### CHAPTER IX

#### THE MAGNETIC CIRCUIT—DESIGN OF FIELD MAGNETS—EFFICIENCY

55. The magnetic circuit of the dynamo . . . . .	185
56. Leakage factor in multipolar dynamos . . . . .	186
57. Calculation of total ampere-turns required on field magnets . . . . .	187
58. Arrangement and calculation of field windings . . . . .	190
59. Temperature rise of field coils . . . . .	193
60. Efficiency . . . . .	195

### CHAPTER X

#### DESIGN OF A CONTINUOUS CURRENT DYNAMO—NUMERICAL EXAMPLE

61. Introductory . . . . .	199
62. Design sheets for 75-kw. multipolar dynamo . . . . .	200
63. Numerical example—Calculations . . . . .	204
64. Design of continuous current motors . . . . .	235

## ALTERNATING-CURRENT GENERATORS

### CHAPTER XI

#### DESIGN OF ALTERNATORS—FUNDAMENTAL CONSIDERATIONS

65. Introductory . . . . .	237
66. Classification of synchronous generators . . . . .	238
67. Number of phases . . . . .	239
68. Number of poles—Frequency . . . . .	241
69. Usual speeds of A.C. generators . . . . .	241
70. E.m.f. developed in windings . . . . .	242
71. Star and mesh connections . . . . .	244
72. Power output of three-phase generators . . . . .	247
73. Usual voltages . . . . .	248
74. Pole pitch and pole arc . . . . .	248
75. Specific loading . . . . .	250
76. Flux density in air gap . . . . .	251
77. Length of air gap—Inherent regulation . . . . .	252

### CHAPTER XII

#### ARMATURE WINDINGS—LOSSES AND TEMPERATURE RISE

78. Types of windings . . . . .	255
79. Spread of winding . . . . .	257
80. Insulation of armature windings . . . . .	258
81. Current density in armature conductors . . . . .	259

Art.		Page
82.	Tooth and slot proportions . . . . .	259
83.	Length and resistance of armature winding . . . . .	260
84.	Ventilation . . . . .	261
85.	Full load developed voltage . . . . .	261
86.	Inductance of A.C. armature windings . . . . .	263
87.	Calculation of armature inductance . . . . .	264
88.	Total losses to be radiated from armature core . . . . .	266
89.	Temperature rise of armature . . . . .	267

## CHAPTER XIII

## AIR-GAP FLUX DISTRIBUTION—WAVE SHAPES

90.	Shape of pole face . . . . .	269
91.	Variation of permeance over pole pitch (Salient pole machines) . . . . .	271
92.	M.m.f. and flux distribution on open circuit (Salient pole machines) . . . . .	272
93.	Special case of cylindrical field magnet with distributed winding . . . . .	272
94.	Armature m.m.f. in alternating-current generators . . . . .	274
95.	Slot leakage flux . . . . .	281
96.	Calculation of slot leakage flux . . . . .	284
97.	Effect of slot leakage on full-load air-gap flux . . . . .	286
98.	Method of determining position of armature m.m.f. . . . .	288
99.	Air-gap flux distribution under load . . . . .	290
100.	Form of developed e.m.f. wave . . . . .	291
101.	Form factor . . . . .	294
102.	Equivalent sine waves . . . . .	295

## CHAPTER XIV

## REGULATION AND EFFICIENCY OF ALTERNATORS

103.	The magnetic circuit . . . . .	299
104.	Regulation . . . . .	301
105.	Factors influencing the inherent regulation of alternators . . . . .	303
106.	Regulation on zero power factor . . . . .	305
107.	Short-circuit current . . . . .	308
108.	Regulation on any power factor . . . . .	309
109.	Influence of flux distribution on regulation . . . . .	311
110.	Outline of procedure in calculating regulation from study of e.m.f. waves . . . . .	312
111.	Efficiency . . . . .	317

## CHAPTER XV

## EXAMPLES OF ALTERNATOR DESIGN

112.	Introductory . . . . .	320
113.	Single-phase alternator . . . . .	321
114.	Design sheets for 5000-kw. turbo-alternator . . . . .	322
115.	Numerical example calculations . . . . .	324
INDEX . . . . .		326

## LIST OF SYMBOLS

- $A$  = area of cross-section; area of surface.  
 $A$  = area of one lobe of periodic wave plotted to polar coördinates.  
 $A_c$  = ampere-conductors in pole pitch.  
 $a$  = coefficient in resistance-temperature formulas.
- $B$  = magnetic flux density (gauss).  
 $B$ , or  $B''$  = magnetic flux density (maxwells per square inch).  
 $B_a$  = instantaneous average value of air-gap density over the armature conductors of one phase.  
 $B_c$  = average air-gap density in zone of commutation.  
 $B_c$  = average or equivalent flux density in pole cores.  
 $B_g$  = flux density in air gap (gausses).  
 $B_g$  = average air-gap density over tooth pitch.  
 $B_p$  = average air-gap density under commutating pole.  
 $B_t$  = actual flux density in teeth.
- B. & S. = Brown and Sharpe wire gage.  
 $b$  = number of brush sets.
- $C$  = electrostatic capacity (farads).  
 $c$  = coefficient of friction.  
 $c$  = length of pole (radial).
- $D$  = diameter of armature core (including teeth).  
 $D_c$  = diameter of commutator (inches).  
 $d$  = diameter of magnet core.  
 $d$  = inside diameter of armature core.  
 $d$  = maximum value of equivalent sine-wave.  
 $d$  = depth of armature slot (length of tooth).  
 $d_e$  = equivalent length of tooth.
- $E$  = electromotive force (e.m.f.); difference of potential (volt).  
 $E_a$  = volts per phase in armature winding.  
 $E_c$  = volts per conductor.  
 $E_c$  = e.m.f. generated in end connections of short-circuited coil during commutation (volts).  
 $E_m$  = mean or average value of e.m.f.  
 $E_0$  = terminal voltage when load is thrown off.  
 $E_s$  = reactance voltage drop per phase (slot leakage only).  
 $E_t$  = terminal voltage.  
 $e$  = instantaneous value of e.m.f. (volts).  
 $e_c$  = instantaneous e.m.f. per armature inductor.
- e.m.f. = electromotive force.
- $f$  = frequency (cycles per second).

## LIST OF SYMBOLS

- $H$  = intensity of magnetic field; magnetizing force (gilberts per centimeter; or gauss).  
 hp. = horsepower.
- $I$  = current, amperes.  
 $I_a$  = current per phase (or per conductor) in alternator armature winding.  
 $I_c$  = current per conductor in armature.  
 $I_m$  = mean or average value of current.  
 $i$  = instantaneous value of current.  
 $i_a$  = instantaneous value of current in armature conductor (for slot leakage calculations).
- k.v.a. = kilovolt-amperes.  
 k.w. = kilowatts.
- $k$  = a constant; any whole number.  
 $k$  = cooling coefficient.  
 $k$  = distribution factor (A.C. armature windings).  
 $k$  = ratio  $\frac{\text{pole arc.}}{\text{armature core length.}}$   
 $k$  = ratio  $\frac{\text{permissible current density at brush tip.}}{\text{average current density over brush contact surface.}}$
- $L$  = inductance; coefficient of self-induction (henry).  
 $L_c$  = length of cylindrical surface of commutator (inches).  
 $l$  = a length, usually expressed in centimeters.  
 $l$  =  $\frac{1}{4}l_c$  (commutation).  
 $l'$  = axial projection of armature end connections beyond slot (A.C. generator).  
 $l''$  = a length expressed in inches.  
 $l_a$  = gross length of armature core.  
 $l_b$  = total axial length of brush contact surface.  
 $l_e$  = length of end portions of armature coil.  
 $l_f$  = leakage factor.  
 $l_n$  = net length of iron in armature core (usually inches).  
 $l_p$  = axial length of commutating pole face.  
 $l_v$  = total axial length taken up by vent ducts.
- $M$  = thickness of commutator mica.  
 $(M)$  = circular mils per ampere.  
 $(m)$  = circular mils.
- m.m.f. = magnetomotive force (gilbert).
- $N$  = number of revolutions per minute.  
 $N_s$  = number of revolutions per second.  
 $n$  = number of radial air ducts in armature core.  
 $n$  = number of slots per pole.  
 $n_s$  = number of slots per pole per phase.

LIST OF SYMBOLS

xiii

- P* = power; watts.  
*P* = permeance.  
*P* = pressure, pounds per square inch.  
*p* = number of poles.  
*p*<sub>1</sub> = number of electrical paths in parallel in armature winding.
- Q* = quantity of electricity.  
*q* = specific loading of armature periphery (ampere-conductors per inch).
- R* = resistance (ohm).  
*R* = resistance of armature coil undergoing commutation.  
*R* = magnetic reluctance (oersted).  
*R''* = resistance between opposite faces of an inch cube of copper (ohm).  
*R*<sub>c</sub> = brush contact resistance per square inch of contact surface.  
*R*<sub>d</sub> = radial depth of armature stampings below slots.  
*R*<sub>0</sub> = resistance at temperature zero degrees.  
*R*<sub>t</sub> = resistance at temperature *t* degrees.  
*r* = ratio  $\frac{\text{pole arc.}}{\text{pole pitch.}}$   
*r* = length of radius vector.
- S* = number of turns in a coil of wire.  
*S* = brush contact surface.  
*s* = slot width.  
*sf* = space factor.  
*SI* = ampere turns.  
*(SI)*<sub>a</sub> = armature ampere-turns per pole.  
*(SI)*<sub>g</sub> = ampere-turns for air gap.
- T* = temperature rise in degrees Centigrade.  
*T* = number of turns in armature coil.  
*T*<sub>c</sub> = number of turns in armature coil between tappings to commutator bars.  
*T*<sub>s</sub> = number of inductors in one slot.  
*t* = interval of time.  
*t* = temperature (degrees Centigrade).  
*t* = thickness of magnet winding.  
*t* = width of tooth.  
*t*<sub>c</sub> = time of commutation.  
*t*<sub>r</sub> = width of rotor tooth.
- V* = peripheral velocity of armature—centimeters per second.  
*V*<sub>c</sub> = surface velocity of commutator—centimeters per second.  
*v* = peripheral velocity—feet per minute.  
*v*<sub>c</sub> = peripheral velocity of commutator surface—feet per minute.  
*v*<sub>a</sub> = average velocity of air in ventilating ducts—feet per minute.



## LIST OF SYMBOLS

- $W$  = power—watts.  
 $W$  = width of brush (circumferential).  
 $W_a$  = brush width (arc) referred to armature periphery.  
 $w$  = a portion of the total (circumferential) width of brush.  
 $w_c$  } = cooling coefficients (armature temperature).  
 $w_d$  }  
 $X$  = reactance (ohm).  
 $Z$  = impedance (ohm).  
 $Z$  = number of inductors in series per phase (A.C. generator).  
 $Z$  = number of inductors on armature (D.C. generator).  
 $Z'$  = total number of inductors (A.C. generator).  
 $\alpha$  = angle denoting slope of coil side in end connections of armature winding.  
 $\alpha$  = angle of phase displacement of developed e.m.f. due to armature cross magnetization.  
 $\beta$  = angle of lag of current behind phase of open-circuit e.m.f.  
 $\Delta$  = current density; amperes per square inch.  
 $\Delta_w$  = maximum current density over contact surface of brush.  
 $\delta$  = clearance between coil sides in end connections of armature windings.  
 $\delta$  = length of actual air gap—tooth top to pole face.  
 $\delta_e$  = length of equivalent air gap in machines with toothed armatures.  
 $\delta_s$  = deflection of shaft (inches).  
 $\theta$  = an angle.  
 $\theta$  = angle of lag ( $\cos \theta$  = power factor).  
 $\lambda$  = slot pitch.  
 $\mu$  = permeability =  $B/H$ .  
 $\pi$  = 3.1416 approximately.  
 $\tau$  = pole pitch (usually in inches).  
 $\Phi$  = magnetic flux—(maxwell).  
 $\Phi$  = total flux entering armature from each pole face.  
 $\Phi_a$  = flux per pole actually cut by armature conductors.  
 $\Phi_c$  = total flux entering teeth comprised in commutating zone.  
 $\Phi_d$  = flux entering armature core through roots of teeth (commutation).  
 $\Phi_e$  = total flux cut by one end of armature coil during commutation.  
 $\Phi_e$  = total flux cut by end connections (both ends) of polyphase armature winding.  
 $\Phi_e$  = "equivalent" slot leakage flux (magnetic circuit closed through roots of teeth).  
 $\Phi'_{e,s}$  = "equivalent" slot flux (magnetic circuit closed through tops of teeth).  
 $\Phi_l$  = leakage flux (maxwells).  
 $\Phi_s$  = total slot leakage flux.  
 $\Phi_\lambda$  = flux entering armature in space of one tooth pitch.  
 $\psi$  = internal power-factor angle.  
 $\psi'$  = "apparent" internal power-factor angle.  
 $\omega$  =  $2\pi f$

# PRINCIPLES OF ELECTRICAL DESIGN

## CHAPTER I

### INTRODUCTORY

By devoting a whole chapter to introductory remarks and generalities which are rarely given a prominent place in modern technical literature, the author hopes not only to explain the scheme and purpose of this book, but to show what may be gained by an intelligent study of the conditions to be met, and the difficulties to be overcome, by the designer of electrical machinery.

The knowledge required of the reader includes elementary mathematics, the use of vectors for representing alternating quantities, the principles of electricity and magnetism, and some familiarity with electrical apparatus and machinery, such as may be acquired in the laboratories of teaching institutions equipped for the training of electrical engineers, or in the handling and operation of electrical plant in manufacturing works and power stations. The principles of the magnetic circuit will be explained here in some detail, because the whole subject of generator design from the electrical standpoint is little more than a practical application of the known laws of the electric and magnetic circuits; but a fair knowledge of the physics underlying the action of electromagnetic apparatus is presupposed.

The conception of the magnetic circuit consisting of closed lines or tubes of induction linked with the electric circuit—involving the *cutting* of these magnetic lines by the conductors in which an e.m.f. is generated—is unquestionably a useful one for the practical engineer; and the student should endeavor to form a mental picture of these imaginary magnetic lines in connection with every piece of electrical apparatus or machinery which he desires to understand thoroughly.

Having clearly realized the general shape and distribution of the magnetic field surrounding a conductor or linked with a coil of wire carrying an electric current, the next step is to calculate with sufficient accuracy for practical purposes the *quantity* of magnetic flux produced by a given current; or the e.m.f. developed by the cutting of a known magnetic field. This leads to the consideration of units of measurement.

The practical units of the C.G.S. system will be used so far as possible; but since engineers of English-speaking countries still prefer the foot and inch for the measurement of length, there must necessarily be a certain amount of conversion from centimeter to inch units, and *vice versa*. This may, at first sight, appear objectionable; but, in the opinion of the writer, there is something to be gained by having to transform results from one system of units to another. The process helps to counteract the tendency of mathematically trained minds to lay hold of symbols and formulas and treat them as realities, instead of striving always to visualize the physical (or natural) reality which these symbols stand for. The same may be said of such alphabetical letters as are in general use to denote certain physical quantities or coefficients; as  $\mu$  for permeability, and  $L$  for the coefficient of self-induction. Familiarity with these symbols tends to obscure the physical meaning of the things they stand for; and although uniformity in the use of symbols in technical literature cannot be otherwise than advantageous,<sup>1</sup> the use of unconventional symbols involves their correct definition, and for this reason their occasional appearance in writings that are professedly of an instructional nature should not be condemned. This point is made here to emphasize the writer's conviction that the student should endeavor to regard symbols and mathematical analysis as convenient means to attain a desired end; and that he should cultivate the habit of forming a concept or mental image of the physical factors involved in every problem, even during the intermediate processes of a calculation, if this can be done.

By way of illustrating the application of fundamental magnetic principles, the design of electromagnets will be taken up before considering the magnetic field of dynamos. This preliminary study should be very helpful in paving the way to the main subject; and the chapter on magnet design has been written with

<sup>1</sup> A list of the symbols used will be found at the beginning of this book.

this end in view: it does not treat of coreless solenoids or magnetic mechanisms with relatively long air gaps; because the air clearance is always small in dynamo-electric machinery.

In the method of design as followed in this book, an attempt is made to base all arguments on scientific facts, and build up a design in a logical manner from known fundamental principles. This is admittedly different from the method followed by the practical designer, who uses empirical formulas and "short cuts," justified only by experience and practical knowledge. It must not, however, be supposed that a commercial machine can be designed without the aid of some rules and formulas which have not been developed from first principles, for the simple reason that the factors involved are either so numerous or so abstruse that they cannot all be taken into account when deriving the final formula or equation. In any case the constants used in all formulas, even when developed on strictly scientific lines, are invariably the result of observations made on actual tests; and many of them, such as the coefficients of friction, magnetic reluctance, and eddy-current loss, are subject to variation under conditions which it is difficult to determine. The formulas used in design are therefore frequently empirical, and they yield results that are often approximations only; but an effort will be made to explain, whenever possible, the scientific basis underlying all formulas used in this book.

A perception of the fitness of a thing to fulfil a given purpose and of the relative importance of the several factors entering into a problem, is essential to the successful designer. This quality, which may be referred to as engineering judgment, is not easily taught; it grows with practice, and is strengthened by the experience gained sometimes through repeated failures; but it is necessary to success in engineering work, whether this is of the nature of invention and designing, or the surmounting of such obstacles and difficulties as will arise in every branch of progressive engineering. All the conditions and governing factors are not accurately known at the outset, and a good designer is able to make a close estimate or a shrewd guess which, in nine cases out of ten, will give him the required proportion or dimension; he will then apply tests based upon established scientific principles in order to check his estimate, and so satisfy himself that his machine will conform with the specified requirements.



A knowledge of the theory and practice of design, the thoroughness of which must depend upon the line of work to be ultimately followed, would seem to be of great importance to every engineer. It may not be of great benefit to all men in the matter of forming judgment and developing ingenuity or inventiveness; but it will at least help to bridge the gap between the purely academic and logically argued teachings of the schools, and the methods of the practical engineer, who requires results of commercial value quickly, with sufficient, but not necessarily great, accuracy, and who usually depends more upon his intuition and his quickness of perception, than upon any logical method of reasoning.

It must not be thought that these remarks tend to belittle or underrate the method of obtaining results through a sequence of logically proven steps; on the contrary, this is the only safe method by which the accuracy of results can be checked, and it is the method which is followed, whenever possible, throughout this book. It is not by the reading of any book that the art of designing can be learned; but only by applying the information gathered from such reading to the diligent working out of numerical examples and problems.

Although the work done in the drafting room is not necessarily designing, it does not follow that the designer need know nothing about engineering drawing. The art of making neat sketches or clear and accurate drawings of the various parts of a machine, is learnt only by practice; yet every engineer, whatever line of work he may follow, should be able not only to understand and read engineering drawings, but to produce them himself at need. It is particularly important that he should be able to make neat dimensioned sketches of machine parts, because, in addition to the practical value of this accomplishment, it is an indication that he has a clear conception of the actual or imagined thing, and can make his ideas intelligible to others. Clear thinking is absolutely essential to the designer. He must be able to visualize ideas in his own mind before he can impart these ideas to others. Young men seldom realize the importance of learning to think, neither do they know how few of their elders ever exercise their reasoning faculty. The man who can always express himself clearly, either in words or by sketches and drawings, is invariably one whose thoughts are limpid and who can therefore realize a clear mental picture of the thing he describes. The ability to

"see things" in the mind is an attribute of every great engineer. Vagueness of thought and mental inefficiency are revealed by untidy and inaccurate sketches, poor composition and illegible writing. It is, however, possible to train the mind and greatly increase its efficiency by developing neatness and accuracy in the making of sketches, and by the study of languages.

The knowledge of foreign languages has an obvious practical value apart from its purely educational advantage, but the study of English, for the engineer of English-speaking countries, is of far greater importance. By enlarging and enriching one's vocabulary through the reading of high class literature, and by paying constant attention to the correct meaning of words and their proper connection in spoken and written language, the clearness of thought important to every engineer, and essential to the designer, may be cultivated to an extent which the average student in the technical schools and engineering universities entirely fails to recognize. In an address delivered on April 8, 1904, to the Engineering Society of the University of Nebraska, DR. J. A. L. WADDELL said,

"Too much stress cannot well be laid on the importance of a thorough study of the English language. Given two classmate graduates of equal ability, energy, and other attributes contributory to a successful career, one of them being in every respect a master of the English language and the other having the average proficiency in it, the former is certain to outstrip the latter materially in the race for professional advancement."

Considering further the difference between the training received by the student in the schools and the training he will subsequently receive in the world of practical things, it must be remembered that the object of technical education is mainly to develop the mind as a thinking machine, and provide a good working basis of fundamental knowledge which shall give weight and balance to all future thinking. The commercial aspect of engineering is seen more clearly after leaving school because it is not easily taught in the class room. The student does not, therefore, get a proper idea of the value of time. Engineering is the economical application of science to material ends, and if the items of cost and durability are omitted from a problem, the results obtained—however important from other points of view—have no engineering value. The cost of all finished work, including that of the raw materials used in construction, is the



cost of labor. Provided the work is carefully done, the element of time becomes, therefore, of the greatest importance. A student in a technical school may be able to produce a neat and correct drawing, but the salary he could earn as a draughtsman in an engineering business might be very small because his rate of working will be slow. The designer must always have in mind the question of cost, not only material cost—which is fairly easy to estimate—but also labor cost, which depends on the size and complication of parts, accessibility of screws and bolts, and similar factors. These things are rarely learned thoroughly except by actual practice in engineering works, but the student should try to realize their importance, and bear them in mind. A study of design will do something toward teaching a man the value of his time. Thus, although it is important to check and countercheck all calculations, and time so spent is rarely wasted, yet it is essential to know what degree of approximation is allowable in the result. This is a matter of judgment, or a sense of the absolute and relative importance of things, which is developed only with practice. What is worth doing, what is expedient, and what would be mere waste of time, may be learned surely, if slowly, by the study and practice of machine design.

It is by taking on responsibilities that confidence and self-reliance are developed; and the student may work out examples in design by following his own methods, regardless of the particular practice advocated by a book or teacher. He can usually check his results and satisfy himself that they are substantially correct. This will give him far more encouragement and satisfaction than the blind application of proven rules and formulas. By making mistakes—that are frequently due to oversights or omissions—and by having to go over the ground a second or third time in order to rectify them, an important lesson is learned, namely, that one must resist the tendency to jump at conclusions. The necessity of checking one's work, and proceeding systematically by doing at the right time and in the right place the particular thing that should be done before all others, is of great value in developing one of the most important qualifications of the engineer. This has already vaguely been referred to as engineering judgment, a sense of proportion, seeing the fitness of things; but all these are allied, if not actually identical, with the one faculty of inestimable value known as

common sense, so called—according to the definition of a witty Frenchman—because it is the least common of the senses.

It should be realized clearly that the true designer is a maker, not an imitator. The function of the designer is to create. His value as a live factor in the engineering world will increase by just so much as he rises above the level of the mere copyist. The man who can see what has to be done, and how it may be done, is always of greater value than the man who merely does a thing, however skilfully, when the manner of doing it has been explained to him.

In addition to a sound knowledge of engineering principles and practice, a designer should preferably have a leaning toward original investigation or research work. He should not be bound by the trammels of convention, nor discouraged by the groundless belief that what has been done before has necessarily been done rightly. On the contrary, he should assert his personality, and have the courage of his own opinions, *provided these are based, and intelligently formed, on established fundamental principles*, the truth and soundness of which are undeniable.

If the chief function of the designing engineer is to create, the cultivation of the imagination is obviously of the utmost value. This is a point that is frequently overlooked. In other creative arts, such as poetry and painting, intuition and a fertile imagination are considered essential to success, and there can be no valid reason for undervaluing the possession of these qualities by the engineer. The work of the designer is artistic rather than purely scientific; that is to say it requires skill and ingenuity in addition to mere knowledge. Without a sound basis of engineering knowledge, the designer is not likely to succeed, because his conceptions, like those of many so-called inventors, would have no practical application; but it is also true that the great designers, even of mechanical and electrical machinery, do not always understand why they have done a certain thing in a certain way. They work by intuition rather than by methods that are obviously logical, but their early training and thorough knowledge of engineering facts and practice act as a constant and useful check, with the result that they rarely make mistakes of serious importance.

It is not suggested that the exalted moods and "inspired imaginings" of the poet or artist would be of material advantage



to the practical engineer; but the present writer wishes to state, most emphatically, that, in his opinion, the average engineer does not rate imagination at its proper value, neither does he cultivate it as he might, did he realize the advantages—if only from a grossly commercial standpoint—that would thereby accrue. There is to-day a tendency to underestimate the value of abstract speculation and the pursuit of any study or enterprise of which the immediate practical end is not obvious. The fact that the indirect benefit to be derived therefrom may, and generally does, greatly outweigh the apparent advantages of so-called utilitarian lines of study, is generally overlooked. It is an admitted fact that the outlook of the graduate from many of the engineering schools is narrow: this is no doubt largely due to faults in the system and the teachers; but the student himself is apt to neglect his opportunities for the study of subjects such as general literature, languages, history, and political economy, on the plea that he would be wasting his time. It is only at a later period of his engineering career that he begins to realize how an intelligent and appreciative study of these broader subjects would have stimulated his mind and cultivated his imagination to a degree which would be a great and lasting benefit to him in his profession.

It is unfortunate that neither the nature of the subject nor the manner in which it is presented in the following chapters is likely to stimulate the imaginative faculty; but the writer believes that no apology is needed for referring in this chapter to subjects outside the scope of the main portion of the book. In presenting fundamental principles and showing how they may be applied to the design of machines, it is necessary to arrange the matter in accordance with some logical scheme; and it is just because a book such as the present one cannot give, and does not claim to give, all that goes to the making of a designing engineer, that it was deemed advisable to say something of a general nature relating to the art of designing electrical machinery.

The principles underlying the action of dynamo-electric machinery may be studied under two main headings:

1. The magnetic condition due to an electric current in a conductor or exciting coil.
2. The e.m.f. developed in a conductor due to changes in the magnetic condition of the surrounding medium.

This last effect, which may be attributed to the cutting of the magnetic lines by the electric conductors, will be considered when taking up the design of dynamos. For the present it will be advisable to investigate condition (1) only, and Chaps. II and III will be devoted to the study of the magnetic circuit; to the calculation of the excitation required to produce a given magnetic flux; or, alternatively, the quantitative determination of the flux when the size, shape, and position, of the exciting coils are known.

## CHAPTER II

### THE MAGNETIC CIRCUIT—ELECTROMAGNETS

In all dynamo-electric machinery, coils of wire carrying electric currents produce a magnetic field in the surrounding medium—whether air or iron—and the purport of this chapter is to show how the magnetic condition due to an electric current can be determined within a degree of accuracy generally sufficient for practical purposes.

The design of the magnetic circuit of dynamo-electric generators does not differ appreciably from the design of electromagnets for lifting or other purposes, and it is, therefore, proposed to consider, in the first place, the fundamental principles and calculations involved in proportioning and winding electromagnets to fulfil specified requirements. Particular attention will be paid to types of magnets with small air gaps because these serve to illustrate the conditions met with in field-magnet design, and the principles of the magnetic circuit can be applied with but little difficulty; while, in the case of coreless solenoids or magnets with very large air gaps, the paths of the magnetic flux cannot readily be predetermined, and empirical formulas or approximate methods of calculation have to be used. When the magnetic circuit is mainly through iron, and the air gaps are comparatively short, it is generally possible to picture the lines or tubes of magnetic flux linking with the electric circuit, thus facilitating the quantitative calculation of the flux at various parts in the circuit; but when the path of the magnetic lines is largely through air or other “non-magnetic” material, the analogy between the magnetic and electric circuits is less convenient and may indeed lead to confusion; the quantitative calculations become more difficult and less scientific, calling for an experienced designer if results of practical value are desired.

**1. The Magnetic Circuit.**—Without dwelling on the mathematical conceptions of the physicist, which may be studied in all books on magnetism, it may be stated without hesitation that the analogy between the magnetic and electric circuits, and the idea of a closed magnetic circuit linked with every electric

circuit, will be most useful to the designer of electrical machinery. The magnetic flux is thought of as consisting of a large number of tubes of induction, each tube being closed upon itself and linked with the electric circuit to which the magnetic condition is due. The distribution of the magnetic field will depend upon the shape of the exciting coils, and upon the quality, shape, and position, of the iron, in the magnetic circuit. The amount of the magnetic flux in a given magnetic circuit will depend upon the m.m.f. (magnetomotive force) and therefore on the current and number of turns of wire in the exciting coils.

OHM'S law for the electric circuit can be put in the two forms:

$$(a) \quad \text{Current} = \frac{\text{e.m.f.}}{\text{resistance}}, \text{ or } I = \frac{E}{R}$$

$$(b) \quad \text{Current} = \text{e.m.f.} \times \text{conductance}, \text{ or } I = E \times \left(\frac{1}{R}\right)$$

Similarly, in the magnetic circuit:

$$(a) \quad \text{Magnetic flux of induction} = \frac{\text{magnetomotive force}}{\text{magnetic reluctance}}$$

or

$$\Phi = \frac{\text{m.m.f.}}{R} \tag{1}$$

$$(b) \quad \text{Magnetic flux} = \text{magnetomotive force} \times \text{permeance}$$

or

$$\Phi = \text{m.m.f.} \times P \tag{2}$$

In this analogy,  $\Phi$  is the total flux of induction, usually expressed in C.G.S. lines, or *maxwells*; m.m.f. is the force tending to produce the magnetic condition—expressed in *ampere-turns* (the engineer's unit) or in *gilberts*—the C.G.S. unit; and *reluctance* is the magnetic equivalent of resistance in the electric circuit. It is necessary to bear in mind that although these are fundamental formulas of the greatest value in the calculation of magnetic circuits, yet they are based on an analogy which, with all its advantages, has its limitations. The chief difference between OHM'S law of the electric circuit and the analogous expression as applied to the magnetic circuit lies in the fact that the magnetic reluctance does not depend merely upon the material, length, and cross-section, of the various parts of the magnetic circuit, but also—when iron is present—on the amount of the flux, or, more properly, on the flux density, which is an important factor in the determination of the *permeability* ( $\mu$ ).

**2. Definitions.**—*Magnetomotive Force.*—The difference of magnetic potential which tends to set up a flux of magnetic induction between two points is called the magnetomotive force (m.m.f.) between those points. The unit m.m.f.—known as the *gilbert*—will set up unit flux of induction between the opposite faces of a centimeter cube of air. If we consider any closed tube of induction linked with a coil of  $S$  turns carrying a current of  $I$  amperes, the total ampere turns producing this induction are  $SI$ , and the total m.m.f. is,

$$\text{m.m.f.} = \frac{4\pi}{10} SI \text{ gilberts.}^1$$

*Magnetizing Force.*—The magnetomotive force per centimeter is called the *magnetizing force*, or *magnetic force*. The symbol  $H$  is generally used to denote this quantity which is also referred to as the *intensity of the magnetic field*, or simply *field intensity*, at the point considered. The magnetomotive force is, therefore, the line integral of the magnetizing force, or,

$$\text{m.m.f.} = \Sigma H \delta l$$

where  $\delta l$  is a short portion of the magnetic circuit—expressed in centimeters—over which the magnetizing force  $H$  is considered of constant value. Thus  $H = 0.4\pi \times$  ampere-turns per centimeter  $= 0.4\pi \frac{SI}{l}$  or, if it is preferred to use ampere-turns per inch (not uncommon in engineering work), we may write  $H = 0.495$  ( $SI$  per inch).

<sup>1</sup> What the practical designer wants to know is the number of ampere-turns required to produce a given magnetic flux. The factor  $\frac{4\pi}{10}$  constantly enters into magnetic calculations as it is required to convert the engineer's unit (ampere-turn) into the C.G.S. unit (gilbert). It should not be necessary to explain its presence here, because this is done more or less lucidly in most textbooks of physics. It should be sufficient to remind the reader that the introduction of this factor is due to the physicist's conception of the unit magnetic pole which he has endued with the ability to repel a similar imaginary pole with a force of 1 dyne when the distance between the two unit poles is 1 cm. Now, since, at every point on the surface of a sphere of 1 cm. radius surrounding a unit magnetic pole placed at the center, a similar pole will be repelled with a force of 1 dyne, there must be unit flux density over this surface; that is to say, a flux of 1 maxwell per square centimeter. The surface of the sphere being  $4\pi$  sq. cm., it follows that  $4\pi$  lines of flux must be thought of as proceeding from every pole of unit strength. The factor 10 in the denominator converts amperes into absolute C.G.S. units of current.



*Magnetic Flux.*—The unit of magnetic flux is the *maxwell*; it should be considered as a tube of induction having an appreciable cross-section which may vary from point to point. The expression “magnetic lines,” which is customary and convenient, should suggest the center lines of these small unit tubes of induction. The total number of unit magnetic lines through a given cross-section will be denoted by the symbol  $\Phi$ .

*Flux Density.*—The unit of flux density is the *gauss*; it is a density of 1 maxwell per centimeter of cross-section. Thus, if  $A$  is the cross-section, in square centimeters, of a magnetic circuit carrying a total flux of  $\Phi$  maxwells uniformly distributed over the section, the flux density is  $B = \Phi/A$  gaussess. The symbol  $B$  will be used throughout to denote gaussess.

*Permeability.*—What may be thought of as the magnetic conductivity of a substance is known as permeability and represented by the symbol  $\mu$ . Unlike electrical conductivity, it is not merely a physical property of the substance, because—in the case of iron, nickel, and cobalt—it depends also upon the flux density. For practical purposes, the permeability of all substances, excepting only iron, nickel, and cobalt, is taken as unity. Permeability can, therefore, be defined as the ratio of the magnetic conductivity of a substance to the magnetic conductivity of air.

*Reluctance and Permeance.*—Magnetic permeance is the reciprocal of reluctance; a knowledge of the permeance of the various paths is useful when considering magnetic circuits in parallel, while reluctance is more convenient to use when making calculations on magnetic paths in series. The reluctance of a path of unit permeability is directly proportional to its length and inversely proportional to its cross-section. Thus,

$$\begin{aligned} \text{Reluctance of magnetic path in air} &= \frac{l}{A} \\ \text{Reluctance of magnetic path in iron} &= \frac{l}{\mu A} \end{aligned}$$

If the dimensions are in centimeters, the reluctance will be expressed in *oersteds*.

$$\text{Permeance} = \frac{1}{\text{reluctance}} = \frac{\mu A}{l}$$

When calculating reluctance or permeance for use in the fundamental formulas (1) or (2) it is important to express all

dimensions in centimeters; no constants have then to be introduced because, with the C.G.S. system of units,

$$\text{Flux in maxwells} = \frac{\text{m.m.f. in gilberts}}{\text{reluctance in oersteds}}$$

The sketch, Fig. 1, shows a (closed) tube of induction linked with a coil of wire of  $S$  turns through which a current of  $I$  amperes is supposed to be passing. This tube of induction consists of a number of unit tubes or so-called magnetic lines each of which is closed on itself. It follows that the total flux  $\Phi$  is the same through all cross-sections of the magnetic tube of flux indicated

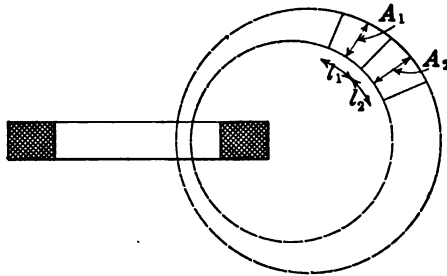

FIG. 1.—Tube of induction linked with coil.

in Fig. 1. The cross-section may, and generally does, vary from point to point of the magnetic circuit, and since the total flux  $\Phi$  is of constant value, the density  $B$  will be inversely proportional to the cross-section. Thus, at a given point where the cross-section is  $A_1$  square centimeters the density in gaussses is  $B_1 = \Phi/A_1$ .

Turning again to the fundamental formula of the magnetic circuit, we have,

$$\text{m.m.f.} = \text{flux} \times \text{reluctance}$$

or

$$\text{gilberts} = \text{maxwells} \times \text{oersteds}$$

or

$$0.4\pi SI = \Phi \times \left( \frac{l_1}{A_1\mu_1} + \frac{l_2}{A_2\mu_2} + \text{etc.} \right) \tag{3}$$

Also, since m.m.f. = magnetizing force  $\times$  length of path, it is sometimes convenient to put the above general expression in the form

$$0.4\pi SI = H_1l_1 + H_2l_2 + \text{etc.} \tag{4}$$

**3. Effect of Iron in the Magnetic Circuit.**—Consider a toroid or closed anchor-ring of iron of uniform cross-section  $A$  square centimeters, wound with  $SI$  ampere-turns evenly distributed.

Applying the fundamental formula  $\Phi = \text{m.m.f.} \times P$ , we have,

$$\Phi = 0.4\pi SI \times \frac{A\mu}{l}$$

in which  $l$  is the average length of the magnetic lines, or  $\pi D$  centimeters, where  $D$  is the average diameter of the ring.

Thus, if  $\mu$  is known, the flux in the ring can be calculated for any given value of the exciting ampere-turns  $SI$ . Since  $\mu$  is a function of the density  $B$ , and  $B = \Phi/A$  it may be convenient to put the above expression in the form

$$B = 0.4\pi SI \frac{\mu}{l}$$

Also, since m.m.f. (in gilberts) =  $Hl$

$$B = Hl \times \frac{\mu}{l}$$

whence  $\mu = \frac{B}{H}$ , which explains why the permeability is sometimes referred to as the multiplying power of the iron. Thus, for a given value of  $H$ , the magnetic flux in air will be  $H$  lines per square centimeter of cross-section, but if the air is replaced by iron, it will be  $\mu H$  or  $B$  lines. This accounts for the fact that  $H$  (the magnetizing force, or m.m.f. per centimeter) is also referred to as the intensity of the magnetic field, or magnetizing intensity, and, as such, expressed in gausses. This conception is liable to lead to confusion of ideas; but it is well to bear in mind that, in air and other "non-magnetic" materials, the numerical value of  $B$  is the same as that of  $H$ .

For a given magnetizing force  $H$  (or exciting ampere-turns per unit length of circuit) the value of the permeability,  $\mu$ , varies considerably with different kinds of iron; it also depends on the past history of the particular sample of iron, and will not be the same on the increasing as on the decreasing curve of magnetization, as indicated by the curve known as the hysteresis loop. For the use of the designer, careful tests are usually made by the manufacturer on samples of iron used in the construction of machines, and curves are then plotted, or tables compiled, based on the average results of such tests. Curves of this kind have been drawn in Figs. 2 and 3. The  $B$ - $H$  curves of Fig. 2 should be preferred when the C.G.S. system of units is used in the



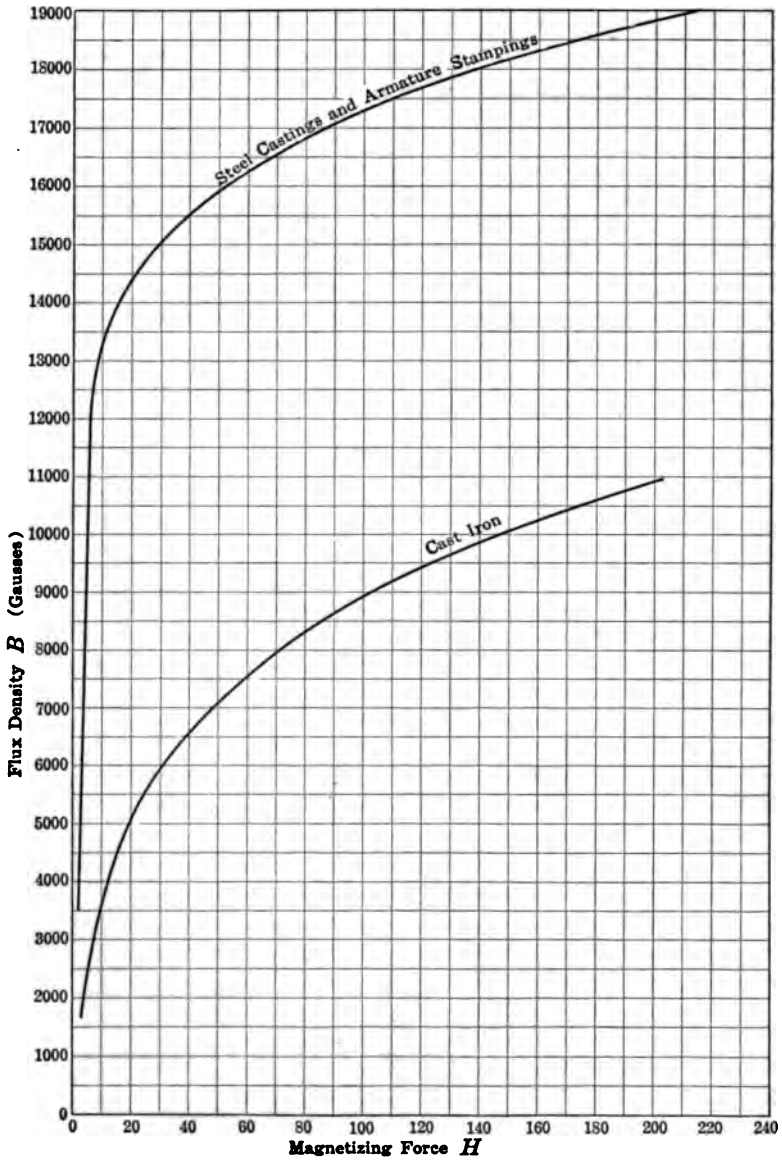

FIG. 2.—B-H curves.

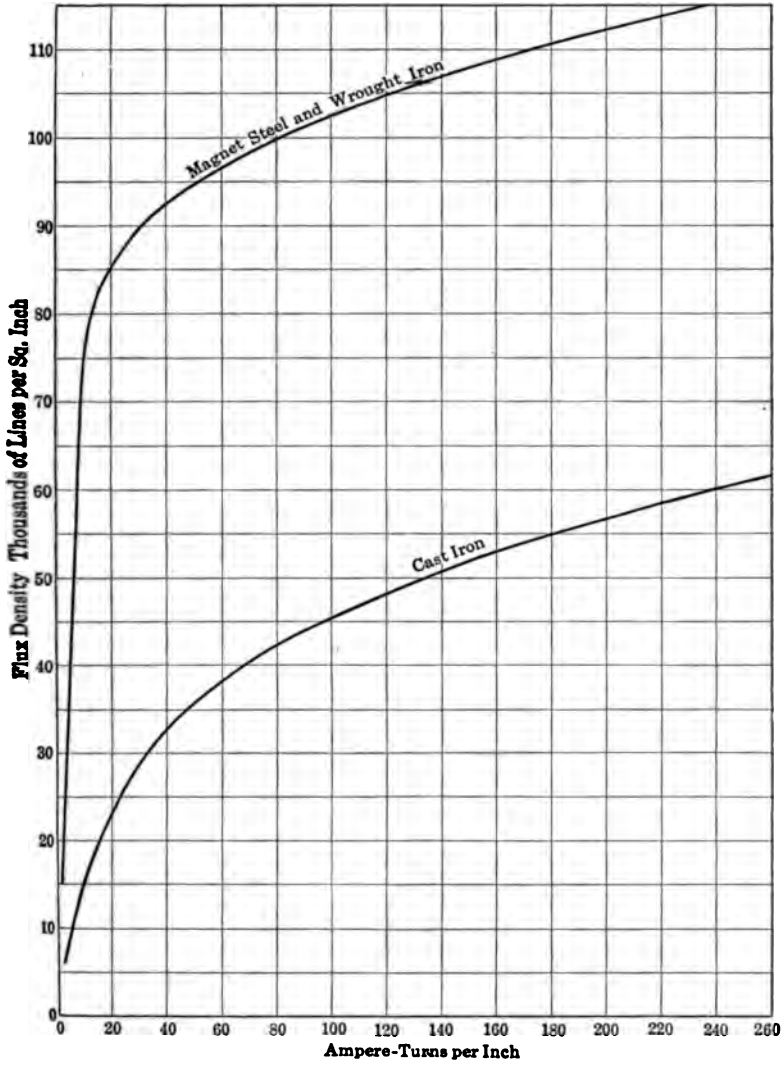

FIG. 3.—Magnetization curves (inch units).

calculations; but so long as engineers persist in expressing linear measurements in feet and inches, the curves of Fig. 3 will generally be preferred by the designer. Fig. 4 may be used for high values of the induction in armature stampings of average quality.

The value of  $\mu$  is, of course, the ratio between  $B$  of Fig. 2 and the corresponding value of  $H$ , and curves or tables giving the relation between  $\mu$  and  $H$  could be used; but it is generally more convenient to read directly off the curves of Figs. 2, 3, or 4, the

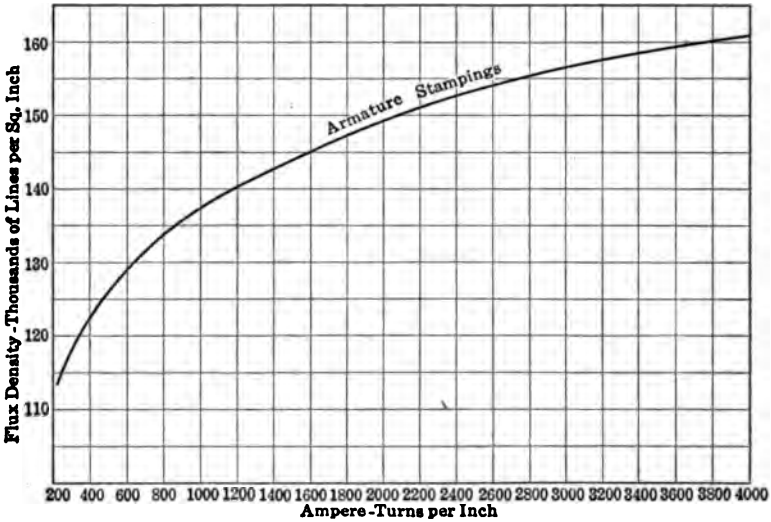

FIG. 4.—Magnetization curve for armature stampings (high values of induction).

flux density in the iron corresponding to any known value of the magnetizing force. As a matter of fact, it will be found that the curves are more frequently used for the purpose of determining the necessary ampere-turns to produce a desired value of the flux density.

**4. Magnetic Circuits in Parallel.**—As an illustration of the fundamental relations existing between magnetic flux and exciting ampere-turns, it will be convenient to work out a numerical example. A simple case will be chosen of magnetic paths in series and in parallel, with small air gaps in a circuit consisting mainly of iron, and the effect of any leakage flux through air paths other than the gaps deliberately introduced will be neglected.

The arrangement shown in Fig. 5 is supposed to represent a steel casting consisting of the magnetic paths (1) and (2) in parallel, with the common path (3) in series with them. It will be seen that the paths (1) and (2) are provided with air gaps and that the exciting coil is on the common limb (3) only. Paths (1) and (3) have iron in them and the permeance of these paths will depend upon the density  $B$  and therefore on the total flux  $\Phi_1$  and  $\Phi_3$  in these portions of the circuit. In regard to path (2), it also consists mainly of iron, but the cross-section of the iron has purposely been made large, so that the reluctance of this path is practically all in the gap; the value of  $B$  in the iron will be very low,  $\mu$  will be large, and the reluctance of this part of the iron circuit will be considered negligible. The dimensions

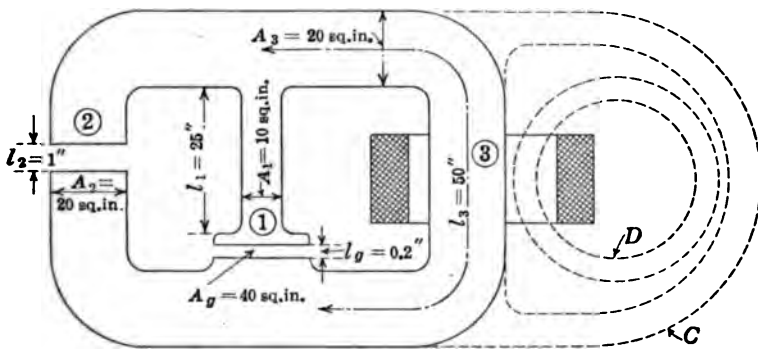

FIG. 5.—Typical magnetic circuit.

of the parts are indicated on the sketch, and the problem to be solved is the calculation of the necessary ampere-turns in the coil to produce a given total flux of, say, 1,000,000 maxwells through the path (1).

The reluctance of path (1) alone consists of the air-gap reluctance in series with the reluctance of the iron limb of length  $l_1$  and cross-section  $A_1$ . Thus,

$$R_1 = \frac{l_g}{A_g \times 1} + \frac{l_1}{A_1 \times \mu_1}$$

all dimensions being expressed in centimeters. The only unknown quantity is  $\mu_1$ , and this can be determined because the flux density in the iron will be

$$B''_1 = \frac{\Phi_1}{A_1} = \frac{1,000,000}{10} = 100,000 \text{ maxwells per square inch,}$$

where the index " is added to the symbol  $B$  to indicate that inch units are used and that the density is not expressed in gaussess.

Knowing  $B$  for a given sample of iron, the value of the permeability  $\mu$  can be found, and  $R_1$  calculated by putting the numerical values in the above equation. The necessary m.m.f. for this portion of the magnetic circuit (*i.e.*, path (1) only) is  $\Phi_1 \times R_1$  gilberts.

The actual procedure would be simplified by using the curves of Fig. 3 thus:

Referring to the upper curve (for steel), the ampere-turns per inch required to produce a flux density of 100,000 lines per square inch is seen to be 80, and since the iron portion of path (1) is 25 in. long, the ampere-turns required to overcome the reluctance of iron only are  $80 \times 25 = 2,000$ .

For the air portion of path (1), we have,

$$\text{m.m.f.} = \Phi_1 \times \text{reluctance of air gap}$$

or

$$0.4\pi SI = 1,000,000 \times \frac{0.2 \times 2.54}{40 \times 6.45}$$

whence

$$SI = 1,560$$

The total  $SI$  for path (1) are therefore  $2,000 + 1,560 = 3,560$  or,

$$\text{m.m.f.} = 0.4\pi \times 3,560 = 4,470 \text{ gilberts.}$$

Observe now that this m.m.f. is the total force which sets up the magnetic flux in path (2), or, in other words, it is the difference of magnetic potential which produces the flux of induction in the two parallel paths (1) and (2). To calculate the total flux in path (2) we have,

$$\begin{aligned} \Phi_2 &= \text{m.m.f.} \times P_2 \\ &= 4,470 \times \frac{20 \times 6.45}{1 \times 2.54} = 227,000 \text{ maxwells} \end{aligned}$$

The total flux in limb (3) under the exciting coil is, therefore,  $\Phi_3 = \Phi_1 + \Phi_2 = 1,227,000$ . The density in this core is,

$$B''_3 = \frac{\Phi_3}{A_3} = \frac{1,227,000}{20} = 61,350 \text{ lines per square inch.}$$

The necessary ampere-turns per inch (from Fig. 3) are 8, and the  $SI$  for path (3) are  $8 \times 50 = 400$ .

The total ampere-turns required in the exciting coil to produce a flux of 1,000,000 lines across the air gap in path (1) are therefore  $3,560 + 400 = 3,960$ , which is the answer to the problem.

In all cases when there is no iron in the magnetic path, *i.e.*, when  $\mu = 1$ , as in the air gaps of dynamo-electric machines, the required ampere-turns depend merely on the density  $B$ , and the length  $l$  of the air gap. The fundamental relation,  $m.m.f. = Hl$  can then be written  $0.4\pi SI = Bl$  whence,

$$\begin{aligned}
 SI \text{ per centimeter (in air)} &= \frac{B}{1.257} \\
 \text{similarly} \\
 SI \text{ per inch (in air)} &= \frac{2.54}{1.257} B = 2.02 B \\
 &= 2B \text{ approximately}
 \end{aligned}
 \tag{5}$$

If the density is expressed in lines per square inch,

$$SI \text{ per inch (in air)} = \frac{B''}{3.2}$$

These formulas are easily remembered and are useful for making rapid calculations.

With a view to the more thorough understanding of electromagnetic problems likely to arise in the design of electrical machinery, it should be observed that path (2) of the magnetic system shown in Fig. 5 may be thought of as a shunt—or leakage—path, the useful flux being the 1,000,000 maxwells in the air gap of path (1). It is important to note that this surplus or leakage magnetism has cost nothing to produce, except in so far as the total flux  $\Phi_3$  is increased in the common limb (3), calling for a slight increase in the necessary exciting ampere-turns. Even this small extra  $I^2R$  loss could be avoided by increasing the cross-section  $A_3$  of the common limb; but this would generally add to the cost, not only because of the greater weight of iron, but also because the length per turn of the exciting coil would usually be greater, thus increasing the weight and cost of copper if the  $I^2R$  losses are to remain unaltered. For these reasons alone it is well to keep down the value of the leakage flux in nearly all designs of electrical machinery; but the point here made is that the existence of a magnetic flux, whether it be useful or leakage magnetism, does not involve the idea of loss of energy in the sense of an  $I^2R$  loss which must always be associated with the electric current. Attention is called to this matter in order

to emphasize the danger of carrying too far the analogy between the magnetic and electric circuits. The product  $I^2R$  in the electric circuit is always associated with loss of energy; but  $\Phi^2 \times \text{reluctance}$  does not represent a continuous loss of energy in the magnetic circuit. If the energy wasted in the exciting coil is ignored, it may be said that the magnetic condition costs nothing to *maintain*. It does, however, represent a store of energy which has not been *created* without cost; but, with the extinction of the magnetic field, the whole of this stored energy is given back to the electric circuit with which the magnetic circuit is linked. This may be illustrated by the analogy of a frictionless flywheel which dissipates no energy while running, but which, on being brought to rest, gives up all the energy that was put into it while being brought up to speed.

The dotted lines on the right-hand side of the magnetic circuit shown in Fig. 5 indicate two extra iron paths for the magnetic flux. It should particularly be observed that the closed iron ring  $D$  can be linked with the exciting coil as indicated without modifying the amount of the useful flux through path (1): there may obviously be a large amount of flux in this closed iron ring, but *it has cost nothing to produce* because the exciting ampere-turns have not been increased. The same might be said of the circuit  $C$  except that the flux in this circuit has to go through the common core (3), and in so far as extra ampere-turns would be necessary to overcome the increased reluctance of the iron under the coil, the m.m.f. available for sending flux through paths (1) and (2) would be reduced, and if path  $C$  were of high-grade iron of large cross-section relatively to  $A_3$ , the useful flux in path (1) might be appreciably reduced. A proper understanding of the points brought out in the study of Fig. 5 will greatly facilitate the solution of practical problems arising in the design of electrical machinery.

**5. Calculation of Leakage Paths.**—The total amount of the magnetic leakage cannot be calculated accurately except by making certain assumptions which are rarely strictly permissible in the design of practical apparatus. Whether the machine is an electric generator or an electromagnet of the simplest design, the useful magnetic flux is always accompanied by stray magnetic lines which do not follow the prescribed path. This leakage flux will always be so distributed that its amount is a maximum; that is to say, the paths that it will follow will always

be such that the total permeance of these leakage paths has the greatest possible value. It is well to bear this fact in mind, because it enables the experienced designer to make sketches of various probable distributions of the leakage flux, and base his calculations on the arrangement of flux lines which has the greatest permeance. The fact that the leakage flux usually follows air paths means that the permeance of these paths does not depend upon the flux density  $B$ ; this simplifies the problem because it is not necessary to take into account values of the permeability,  $\mu$ , other than unity; the difficulty lies in the fact that—with the exception of very short air gaps between relatively large polar surfaces—it is rarely possible to predetermine the distribution of the stray flux, except by making certain convenient assumptions of questionable value. A designer of experience will frequently be able to estimate flux leakage even in new and complicated designs with but little error, and it is surprising how the intelligent application of empirical or approximate formulas and rules will often conduce to excellent results. The errors introduced are some on the high side and some on the low side, and the averages are fairly accurate; but the estimation of leakage flux—like many other problems to be solved by the designer or practical engineer—savors somewhat of scientific guesswork; it calls for a combination of common sense and engineering judgment based on previous experience. The following examples and formulas cover some of the simplest cases of flux paths in air; the usual assumptions are made regarding the paths followed by the magnetic lines, but it may safely be stated that, when all possible leakage paths have been considered, and these formulas applied to the calculation of the leakage flux, the calculated value will almost invariably be something less than the actual stray flux as subsequently ascertained by experimental means.

*Case (a).—Parallel Flat Surfaces.*—If the length of air gap between the parallel iron surfaces is small relatively to the cross-section, and if the two surfaces are approximately of the same shape and size, the average cross-section (see Fig. 6) is

$$A = \frac{A_1 + A_2}{2}$$

and the permeance is

$$P = \frac{A}{l} \tag{6}$$



all dimensions in this and subsequent examples being expressed in centimeters.

*Case (b).—Flat Surfaces of Equal Area Subtending an Angle  $\theta$ .*—The assumption here made is that the lines of induction in the air gap are circles described from a center on the axis  $O$  where the planes of the two polar surfaces meet. Let  $l$  = length of polar surface at right angles to the plane of the section shown in Fig. 7. The sum of the permeances of all the small paths such as  $dr$  is then,

$$P = \int_{r_1}^{r_2} \frac{l \times dr}{2\pi r \times \frac{\theta}{360}} = \frac{360l}{2\pi\theta} \log \epsilon \frac{r_2}{r_1} \quad (7)$$

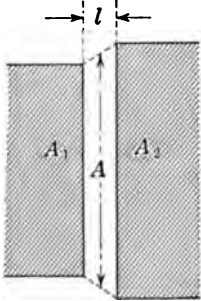

FIG. 6.—Permeance between parallel surfaces.

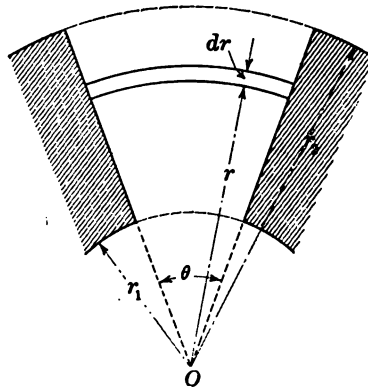

FIG. 7.—Permeance between non-parallel plane surfaces.

For the special case when  $\theta = 90$  degrees,

$$P = \frac{2l}{\pi} \log \epsilon \frac{r_2}{r_1} \quad (8)$$

For the special case when  $\theta = 180$  degrees, and the two surfaces lie in the same plane,

$$P = \frac{l}{\pi} \log \epsilon \frac{r_2}{r_1} \quad (9)$$

*Case (c).—Equal Rectangular Polar Surfaces in Same Plane.*—This is a case similar to the one last considered, but the formula (9) is not applicable when  $r_1$  is large relatively to  $r_2$  because the actual flux lines would probably be shorter than the assumed semicircular paths. With a greater separation between the polar

surfaces, the lines of flux are supposed to follow the path indicated in Fig. 8. Let  $l$  stand, as before, for the length measured perpendicularly to the plane of the section shown, then,

$$\begin{aligned}
 P &= \int_0^t \frac{l \times dr}{(\pi r + s)} \\
 &= \frac{l}{\pi} \int_0^t \frac{dr}{r + \frac{s}{\pi}} \\
 &= \frac{l}{\pi} \left[ \log_e \left( t + \frac{s}{\pi} \right) - \log_e \left( 0 + \frac{s}{\pi} \right) \right] \\
 &= \frac{l}{\pi} \log_e \frac{\pi t + s}{s} \tag{10}
 \end{aligned}$$

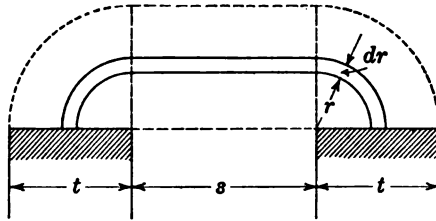

FIG. 8.—Permeance between surfaces in same plane.

*Case (d).—Iron-clad Cylindrical Magnet.*—Fig. 9 shows a section through a circular magnet such as might be used for lifting purposes. The exciting coil is supposed to occupy a comparatively small portion of the total depth, and in order to calculate the total flux between the inner core and the outer cylinder forming the return path for the useful flux we may consider the reluctance of the air path as being made up of a number of concentric cylindrical shells of height  $h$  and thickness  $dx$ . Thus,

$$\begin{aligned}
 \text{reluctance} &= \sum_r^R \frac{dx}{2\pi x h} \\
 &= \left( \frac{1}{2\pi h} \right) \log_e \frac{R}{r}
 \end{aligned}$$

The reciprocal of this quantity is the permeance, whence,

$$P = \frac{2\pi h}{\log_e \frac{R}{r}} \tag{11}$$

When the radial depth of the winding space  $(R - r)$  is not

greater than the radius of the iron core ( $r$ ), the permeance may be expressed with sufficient accuracy for practical purposes as

$$P = \frac{\text{mean cross-sectional area}}{\text{length of flux path}} = \frac{\pi (R + r)h}{(R - r)} \quad (11a)$$

*Case (e).—Same as Case (d) Except that Coils Occupy the Whole of the Available Space.*—This is the more usual case, and it is illustrated by Fig. 10. The leakage flux in the annular space occupied by the windings will depend not only upon the

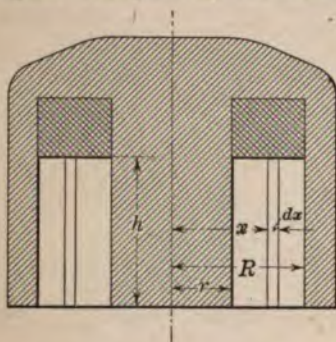

FIG. 9.—Leakage paths in circular magnet (space not occupied by copper).

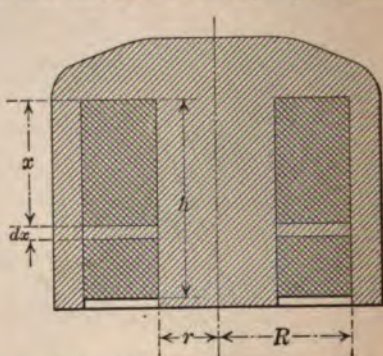

FIG. 10.—Leakage paths in circular magnet (space entirely fitted by exciting coils).

permeance of the air path, but also upon the m.m.f. tending to establish a magnetic flux. This m.m.f. has no longer a constant value, but, on the assumption that the reluctance of the iron paths is negligible, it will increase according to a straight-line law from zero when  $x = 0$  (see Fig. 10) to a maximum when  $x = h$ .

Starting with the fundamental formula,  $\Phi = \text{m.m.f.} \times P$ , we have,

$$d\Phi = \left[ 0.4\pi SI \times \frac{x}{h} \right] \times \left[ \frac{2\pi dx}{\log_e \frac{R}{r}} \right]$$

whence

$$\Phi = 0.4\pi SI \times \frac{1}{h} \times \frac{2\pi}{\log_e \frac{R}{r}} \int_0^h x dx$$

or

$$\Phi = \frac{0.4\pi SI}{2} \times \frac{2\pi h}{\log_e \frac{R}{r}} \quad (12)$$

which, if the dimensions are in centimeters, will be the leakage flux in maxwells; and this is seen to be merely the product, *average value of m.m.f. × permeance*.

It is evident that this formula can be applied to case (d) in order to calculate the leakage flux in the space occupied by the coil, and so obtain the total leakage flux inside a magnet of the type illustrated, where the coils do not occupy the whole of the annular air space between the core and the cylinder forming the return path.

*Case (f).—Parallel Cylinders.*—The permeance of the air paths between the sides of two parallel cylinders of diameter *d* and

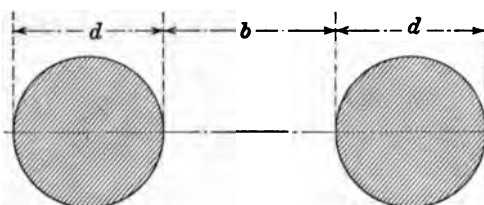

FIG. 11.—Permeance between parallel cylinders.

length *l*—which are shown in section in Fig. 11—cannot be calculated so easily as in the examples previously considered; but the following formula may be used,<sup>1</sup>

$$P = \frac{\pi l}{\log \epsilon \left( \frac{d}{b + d - \sqrt{b^2 + 2bd}} \right)} \tag{13}$$

It will be observed that the logarithm in this and previous equations is to the base  $\epsilon$ , and although the formula could be rewritten to permit of the direct use of tables of logarithms to the base 10, there appears to be no good reason for doing so. If a table of hyperbolic logarithms is not available, the quantity *log*, can always be obtained by using a table of common logarithms and multiplying the result by the constant 2.303.

**6. Flux Leakage in Similar Designs.**—In all the above formulas it will be seen that the permeance, *P*, remains unaltered *per unit length* measured perpendicularly to the cross-section shown

<sup>1</sup> This formula can be developed mathematically in the same manner as the better-known formulas giving the electrostatic capacity between parallel wires.

in the sketches<sup>1</sup> provided the cross-sections are similar, apart from the actual magnitude of the dimensions. Thus, if the exciting ampere-turns were to remain constant, the leakage flux in similar designs of apparatus would be proportional to the first power of the linear dimension  $l$ ; but since the cross-section of the winding space is proportional to  $l^2$ , the exciting ampere-turns would not remain of constant value, but would also vary approximately as  $l^2$ . Given the same size of wire—which obviates the necessity of considering changes in the winding space factor—the number of turns,  $S$ , will be proportional to  $l^2$ , and the resistance,  $R$ , will vary as  $l^3$ . For the same rise of temperature on the outside of the windings, the watts lost in heating the coil must be proportional to the cooling surface. Thus,

$$\begin{aligned} I^2 R &\propto l^2 \\ S &\propto l^2 \\ R &\propto l^3 \end{aligned}$$

whence

$$I^2 \propto \frac{1}{l}$$

and

$$SI \propto l^{1.5}$$

The total leakage flux in *similar* designs of magnets will be proportional to  $l \times l^{1.5}$  or  $l^{2.5}$ , and as a rough approximation it may be assumed that, with a proportional change in all linear dimensions, the leakage flux will vary as the third power of the linear dimension, or as the *volume* of the magnet.

**7. Leakage Coefficient.**—The leakage coefficient, or leakage factor, is the ratio  $\frac{\text{useful flux} + \text{leakage flux}}{\text{useful flux}}$

or

$$lf = \frac{\Phi_a + \Phi_l}{\Phi_a}$$

where  $\Phi_l$  is the total number of leakage lines calculated for every path where an appreciable amount of leakage is likely to occur.

When designing electromagnets or the frames of dynamo machines, a fairly close estimate of the probable leakage factor is necessary in order to be sure that sufficient iron section will be

<sup>1</sup> The sections shown in Figs. 9 and 10 have, for convenience, been taken through the axis of length instead of at right angles to this axis as in the other examples.

provided under the magnetizing coils and in the yoke to carry the leakage flux in addition to the useful flux. The leakage factor is always greater than unity, and the product of the useful flux by the leakage factor will be the total flux to be carried by certain portions of the magnetic circuit enclosed by the exciting coils.

**8. Tractive Force.**—The tractive effort, or the tension which exists along the magnetic lines of force, is one of the effects of magnetism which it is necessary to calculate, not only in electromagnets for lifting purposes, or in magnetic clutches or brakes, where this is the most important function of the magnetism; but also in rotating electric machinery, where decentralization of the rotating parts may lead to very serious results owing to the unbalancing of the magnetic pull.

MAXWELL'S formula is,

$$\text{Force in dynes} = \frac{B^2}{8\pi}A \quad (14)$$

where  $A$  is the cross-section in square centimeters of a given area over which the flux density,  $B$ , is assumed to have a constant value.

This formula can be used to calculate the pull between two parallel polar surfaces when the air gap between them is small relatively to the area of the surfaces. The engineer desires to know the pull in pounds exerted between the two surfaces, and since 1 lb. = 444,800 dynes, the above formula can be written,

$$\text{pull, in pounds per square centimeter} = \frac{B^2}{11,180,000} \quad (15)$$

or

$$\text{pull, in pounds per square inch} = \frac{B^2}{1,730,000} \quad (16)$$

In both of these formulas the density,  $B$ , is expressed in gausses (*i.e.*, in C.G.S. lines per square centimeter).

If  $B_{\text{in}}$  stands for lines per square inch, then,

$$\text{pull, in pounds per square inch} = \frac{B_{\text{in}}^2}{72 \times 10^6} \quad (17)$$

If the density is not constant over the whole surface considered, the area must be divided into small sections, after which a summation of the component forces can be made. In averaging the density to get a mean result, it is obviously not the square of the average density that must be taken, but the average of the

squares of the densities taken over the various component areas of the cross-section considered. This is briefly summed up in the general expression,

$$\text{pull, in dynes} = \frac{1}{8\pi} \int B^2 dA$$

*Pull between Inclined Surfaces.—Conical Plungers.*—Sketch (a) of Fig. 12 shows a portion of an electromagnet of rectangular cross-section, with air gap (of length  $l$ ) normal to the direction of movement. The sketch (b) shows a similar bar of iron, but with the air gap inclined at an angle  $\theta$  with the normal cross-section. The total movement, which is supposed to be confined to the direction parallel to the length of the bar, is the same in both cases; that is to say, the air gap measured in the direction

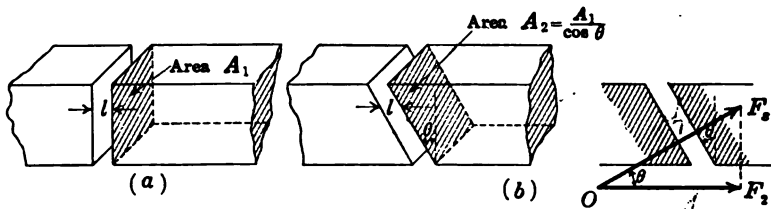

FIG. 12.—Magnet with inclined air gap.

of motion, has the same value,  $l$ , although the actual air gap measured normally to the polar surfaces is smaller in (b) than in (a). The magnetic pull will actually be exerted in a direction normal to the opposing surfaces, that is to say, in the direction  $OF_s$  in case (b), although it is the mechanical force exerted in the direction  $OF_2$  which it is proposed to calculate.

For the perpendicular gap (sketch a) we can write,

$$\text{total longitudinal force } F_1 = kB_1^2 A_1 \quad (18)$$

where  $k$  is a constant.

For the inclined gap (sketch b);

$$\text{total longitudinal force } F_2 = kB_2^2 A_2 \times \cos \theta \quad (19)$$

Now express equation (19) in terms of  $A_1$  and  $B_1$ . With the ampere-turns of constant value, and considering the reluctance of the air gap only, the flux density will be inversely proportional to the shortest distance between the two parallel surfaces. Thus,

$$B_1 \propto \frac{1}{l}$$

$$B_2 \propto \frac{1}{l \cos \theta}$$

therefore

$$B_2 \propto \frac{B_1}{\cos \theta}$$

Also, since

$$\begin{aligned} A_2 &= \frac{A_1}{\cos \theta} \\ F_2 &= k \frac{B_1^2}{\cos^2 \theta} \times \frac{A_1}{\cos \theta} \times \cos \theta \\ &= \frac{k B_1^2 A_1}{\cos^2 \theta} = \frac{F_1}{\cos^2 \theta} \end{aligned} \quad (20)$$

The same relation holds good for cone-shaped pole pieces. Thus, referring to Fig. 13, in which the magnet core is supposed to have a circular cross-section of radius  $r$ ;

$$F_1 = k B_1^2 A_1 = k B_1^2 \pi r^2 \text{ for normal gap}$$

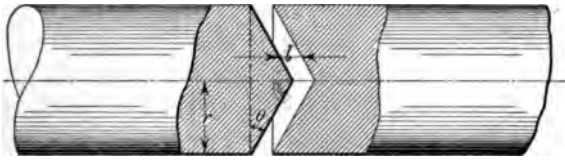

FIG. 13.—Magnet with conical pole faces.

and

$$F_2 = k B_2^2 A_2 \times \cos \theta$$

for conical gap; where the factor  $\cos \theta$  is introduced as before to obtain the axial component of the magnetic forces.

The conical surface, which corresponds to the cross-sectional area of the air gap, is,

$$A_2 = \frac{1}{2} \times 2\pi r \times \frac{r}{\cos \theta} = \frac{\pi r^2}{\cos \theta} = \frac{A_1}{\cos \theta}$$

Also, for the same exciting ampere-turns, we have as before,

$$\begin{aligned} B_2 &\propto \frac{1}{l \cos \theta} \\ &\propto \frac{B_1}{\cos \theta} \end{aligned}$$

and,

$$\begin{aligned} F_2 &= k \frac{B_1^2}{\cos^2 \theta} \times \frac{A_1}{\cos \theta} \times \cos \theta \\ &= \frac{k B_1^2 A_1}{\cos^2 \theta} \\ &= \frac{F_1}{\cos^2 \theta} \end{aligned}$$

which is identical with formula (20).



Thus in both cases the inclined gap has the effect of increasing the initial pull for the same total length of travel. This is sometimes an advantage, and conical poles are occasionally introduced in designs of electromagnets when the total travel is small relatively to the diameter of the plunger. In this manner it is possible to obtain increased length of travel without adding to the weight of the magnet. For *the same initial pull*, the length of travel obtainable by providing conical surfaces is,

$$l_2 = \frac{l_1}{\cos^2 \theta}$$

where  $l_1$  is the length of the normal gap which corresponds to the required initial pull. This formula is easily derived from the expressions previously developed.

There is a limit to the amount of taper that can be put on the conical pole pieces, and a large amount of taper will prove to be of little use. It should be noted that a limit of usefulness is reached when the flux density in the iron core approaches saturation limits, because the air-gap density—which determines the magnetic pull—cannot then be carried up to high values, even with greatly increased exciting ampere-turns. A reference to the curves of Figs. 2 or 3 (pages 16, 17) will enable the designer to judge when the density in the magnet is approaching uneconomical values. Thus, in the case of cast iron it will rarely pay to carry the induction above 11,000 gaussses, while, in wrought iron, or cast steel as used for electromagnets,<sup>1</sup> the upper limit may be placed at about 19,000 gaussses, although, as will be explained later, it is often advantageous to force the density up to higher values in the teeth of laminated armature cores.

**9. Materials—Wire and Insulation.**—Before going further into the design of electromagnets it will be advisable to consider briefly the qualities of the materials used in their construction. The most important of these materials is the iron, which concentrates the magnetic flux and so provides the necessary distribution and density in the air gap where it performs the duty required of it. The effect of iron in the magnetic circuit has however already been discussed at some length, and as its various properties will be considered further in the course of subsequent articles, it is proposed to confine the remarks immediately fol-

<sup>1</sup> This is practically pure iron, with magnetic characteristics very similar to those of soft annealed iron of good quality.

lowing to the only other materials of consequence in the design of magnets or dynamos, namely, the copper wire, which is the material universally used for the windings, and the insulating materials, which prevent electrical contact between neighboring turns of wire, and also between the winding as a whole and the iron of the magnetic circuit or supporting framework.

For the operation of electromagnets, high voltages are rarely used, and the provision of appropriate insulation presents no serious difficulties; but it must not be overlooked that, when the inductance is great—*i.e.*, when the flux links with a large number of turns and the product *maxwells*  $\times$  *number of turns* is large—there may be, at the instant of switching off the current, differences of potential between neighboring turns of wire, considerably in excess of the normal potential difference calculated on the assumption of a steady impressed voltage between the terminals of the coil. In the design of continuous-current machines, pressures up to 5,000 volts may have to be considered, and in alternating-current generators, the pressure may be as high as, but rarely in excess of, 16,000 volts. The higher pressures, as used for transmission of energy to great distances, are obtained by means of static transformers, and the question of insulation then becomes of such great importance that it has to be very thoroughly studied by experts. Pressures of 100,000 volts are now common for step-up transformers, and there are many transformers actually in operation at 150,000 volts and even higher pressures; so that the provision of the requisite insulation for machines working at pressures not exceeding 16,000 volts (which is the limit for any of the designs dealt with in this book) offers no insuperable difficulties. It is, therefore, proposed to devote but little space to the discussion of insulation problems; although, as occasion arises, data and information of a practical nature will be given.

*Copper Wire.*—With silver as the one exception, copper is the metal with the highest electrical conductivity; it is also mechanically strong, easy to handle, and generally the most suitable material for electrical windings. The resistance of a given size and length of wire is usually obtained by reference to a wire table, similar to the accompanying tables, which contain such information as the designer of electrical apparatus requires. The very large, and the very small, sizes of wire are omitted; but wire tables for the use of electrical engineers are

so common in electrical handbooks and textbooks, that particulars of sizes not here included can generally be obtained without difficulty.

The Brown and Sharp gage is commonly used in America, while the legal standard gage (S.W.G.)—which has been adopted by the Engineering Standards Committee—is used almost without exception by electrical engineers in England. In using the accompanying tables, reference should always be made to the heading, to ensure that the figures relate to the required wire gage.

WIRE TABLE, BROWN AND SHARP GAGE, COPPER

Gage No., B. & S.	Diameter, inches (bare)	Area of cross-section		Weight, lb. per 1,000 ft. (bare)	Approx. diameter D.C.C. (mils)	Approx. number of turns per inch D.C.C.	Resistance, ohms per 1,000 ft. <sup>1</sup>		Gage No., B. & S.
		Square inches	Circular mils				15°C. (59°F.)	60°C. (140°F.)	
0	0.3240	0.08291	105,560	319.5	338	2.95	0.0964	0.1142	0
1	0.2893	0.06573	83,690	253.3	302	3.30	0.1217	0.1440	1
2	0.2576	0.05212	66,370	200.9	270	3.69	0.1534	0.1816	2
3	0.2294	0.04133	52,630	150.3	242	4.12	0.1934	0.2290	3
4	0.2043	0.03278	41,740	126.4	216	4.60	0.2439	0.2888	4
5	0.1819	0.02600	33,090	101.2	194	5.13	0.3076	0.3642	5
6	0.1620	0.02061	26,250	79.5	174	5.70	0.388	0.459	6
7	0.1443	0.01635	20,820	63.0	156	6.36	0.489	0.579	7
8	0.1285	0.01297	16,510	50.0	140	7.10	0.617	0.730	8
9	0.1144	0.01028	13,090	39.6	126	7.88	0.778	0.921	9
10	0.1019	0.00815	10,380	31.4	114	8.70	0.981	1.161	10
11	0.0907	0.00646	8,230	24.9	103	9.60	1.237	1.464	11
12	0.0808	0.00513	6,530	19.8	93	10.65	1.559	1.846	12
13	0.0720	0.00407	5,178	15.7	84	11.80	1.966	2.328	13
14	0.0641	0.00323	4,107	12.43	76	13.0	2.480	2.936	14
15	0.0571	0.00256	3,260	9.86	68	14.5	3.127	3.702	15
16	0.0508	0.00203	2,583	7.82	62	15.9	3.942	4.667	16
17	0.0453	0.00161	2,048	6.20	56	17.5	4.973	5.887	17
18	0.0403	0.001276	1,624	4.92	51	19.2	6.27	7.42	18
19	0.0359	0.001012	1,288	3.90	46	21.3	7.90	9.36	19
20	0.0320	0.000802	1,022	3.09	42	23.3	9.97	11.80	20
21	0.0285	0.000636	810	2.45	38	25.6	12.57	14.88	21
22	0.0253	0.000503	642	1.945	35	27.8	15.86	18.77	22
23	0.0226	0.000401	510	1.542	32	30.3	20.00	23.66	23
24	0.0201	0.000317	404	1.223	30	32.3	25.20	29.84	24
25	0.0179	0.000252	320	0.970	27	35.7	31.80	37.60	25
26	0.0159	0.0001985	254	0.769	24	40.0	40.20	47.50	26
27	0.0142	0.0001584	202	0.610	22	43.5	50.60	60.00	27
28	0.0126	0.0001247	159	0.484	21	45.5	63.80	75.40	28

<sup>1</sup> A variation in resistance up to 2 per cent. increase on the calculated values for pure copper is generally allowed.

THE MAGNETIC CIRCUIT—ELECTROMAGNETS 35

WIRE TABLE, STANDARD WIRE GAGE, COPPER

Gage No., S.W.G.	Diameter, inches, (bare)	Area of cross-section		Weight, lb. per 1,000 ft. (bare)	Approx. diameter D.C.C. (mils)	Approx. number of turns per inch D.C.C.	Resistance, ohms per 1,000 ft. <sup>1</sup>		Gage No., S.W.G.
		Square inches	Circular mils				15°C. (59°F.)	60°C. (140°F.)	
0	0.324	0.08245	105,000	318.0	340	2.93	0.097	0.1148	0
1	0.300	0.07070	90,000	272.0	316	3.15	0.1131	0.1339	1
2	0.276	0.05980	76,180	231.0	292	3.41	0.1337	0.1583	2
3	0.252	0.05000	63,500	192.0	268	3.72	0.1604	0.1900	3
4	0.232	0.04230	57,820	166.0	248	4.01	0.1892	0.2240	4
5	0.212	0.03530	44,940	136.0	228	4.37	0.2260	0.2683	5
6	0.192	0.02895	36,860	111.5	208	4.78	0.2767	0.3276	6
7	0.176	0.02433	30,980	93.8	192	5.18	0.3291	0.3896	7
8	0.160	0.02010	25,600	77.5	174	5.72	0.398	0.471	8
9	0.144	0.01630	20,740	62.8	158	6.28	0.491	0.581	9
10	0.128	0.01287	16,380	49.6	140	7.10	0.625	0.740	10
11	0.116	0.01057	13,460	40.7	128	7.75	0.759	0.902	11
12	0.104	0.00850	10,820	32.7	116	8.55	0.941	1.114	12
13	0.092	0.00665	8,465	25.6	104	9.52	1.203	1.424	13
14	0.080	0.00503	6,400	19.4	92	10.75	1.591	1.884	14
15	0.072	0.00407	5,185	15.7	84	11.75	1.964	2.325	15
16	0.064	0.00322	4,095	12.4	76	13.0	2.486	2.943	16
17	0.056	0.00246	3,135	9.5	68	14.5	3.246	3.844	17
18	0.048	0.00181	2,305	7.0	58	17.0	4.420	5.234	18
19	0.040	0.001257	1,600	4.84	50	19.6	6.37	7.54	19
20	0.036	0.001018	1,296	3.92	46	21.3	7.85	9.30	20
21	0.032	0.000804	1,024	3.10	42	23.2	9.94	11.77	21
22	0.028	0.000616	784	2.37	38	25.6	12.99	15.38	22
23	0.024	0.000452	576	1.74	34	28.6	17.67	20.93	23
24	0.022	0.000380	484	1.47	31	31.0	21.08	24.91	24
25	0.020	0.000314	400	1.21	29	33.0	25.50	30.20	25
26	0.018	0.000255	324	0.98	27	36.0	31.40	37.20	26
27	0.0164	0.000211	270	0.81	25	38.0	37.80	44.70	27
28	0.0148	0.000172	219	0.665	24	40.0	46.50	55.00	28

<sup>1</sup> A variation in resistance up to 2 per cent. increase on the calculated values for pure copper is generally allowed.

The cross-section of a wire may be expressed in square inches or in square mils (1 mil = 1/1000 in.); the metric system is rarely used in English-speaking countries.

*Circular Mils.*—The cross-section of a wire or conductor may also be expressed in “circular mils.” This is the unit of area commonly used in America when the cross-section of electrical conductors is referred to. The confusion of ideas resulting from the conception of the circular mil as a unit of area may be compensated for by certain practical advantages, but these advantages are not obvious. The circular mil is the area of a circle 1 mil



in diameter, and the number of circular mils in a given area is therefore greater than the number of square mils. Thus, in 1 sq. in. there are 1,000,000 square mils; but  $10^6 \times \frac{4}{\pi} = 1,273,237$  circular mils. The cross-section of a cylindrical wire in circular mils is,

$$(m) = (\text{diameter in mils})^2 \\ = \frac{\text{true area in square mils}}{0.7854}$$

The area of any conductor expressed in circular mils is always greater than the true area expressed in square mils.

*Simple Formulas for Resistance of Wires.*—A very convenient and easily remembered rule is that the resistance of any copper wire<sup>1</sup> is 1 ohm per circular mil per inch length, or

$$R = \frac{l'}{(m)} \quad (21)$$

at a temperature of about 60°C. (or 140°F.). This formula is therefore applicable to the calculation of coil resistances under operating conditions, when they are hot.

The system on which the B. & S. (Brown and Sharp) gage is based, exactly halves the cross-section with an increase of three sizes. It will also be found that a No. 10 B. & S. copper wire has a cross-section of about 10,000 circular mils (diameter = 0.1 in. approx.) and its resistance at normal temperatures (about 20°C.) is 1 ohm per 1,000 ft. Thus, for approximate calculations, sizes of wire on the B. & S. gage can be determined if necessary without reference to tables.

The weight of any size of round copper wire may be calculated by the formula:

$$\text{Weight in pounds per 1,000 ft.} = \frac{d^2}{330} \quad (22)$$

where  $d$  = diameter in mils.

*Variation of Resistance with Temperature.*—If the resistance of a wire is known for any given temperature it can readily be calculated for any other temperature by remembering that the resistance of all pure metals tends to become zero at the absolute zero of temperature, and that the variations in resistance follow

<sup>1</sup>The specific resistance of commercial wires can be, and usually is, equal to that of pure electrolytic copper of 100 per cent. conductivity by Matthiesson's standard.

a straight-line law, all as indicated in Fig. 14. Thus, if  $R_t$  and  $R_0$  stand respectively for the resistances at temperatures of  $t$  degrees and zero degrees, the relation is,

$$R_t = R_0(1 + at) \quad (23)$$

If it is desired to calculate the change in resistance which occurs when the temperature is raised from  $t_1$  to  $t_2$  degrees, we have,

$$\begin{aligned} R_2 &= R_0(1 + at_2) \\ R_1 &= R_0(1 + at_1) \end{aligned}$$

Dividing the first equation by the second, in order to eliminate  $R_0$ , we get,

$$R_2 = \frac{(1 + at_2)}{(1 + at_1)} R_1 \quad (24)$$

by which the resistance  $R_2$  at the temperature  $t_2$  can be calculated when the resistance  $R_1$  at the temperature  $t_1$  is known.

The coefficient  $a = 0.004$  if the temperatures are expressed in degrees Centigrade. If temperatures are read on the Fahrenheit scale,  $a = 0.0024$ .

*Numerical Example—Change of Resistance with Temperature.*—The resistance of copper per circular mil per foot is 12 ohms at 60°C. Calculate the temperature at which the resistance will be 10 ohms per circular mil per foot.

$$\begin{aligned} R_{60} &= R_0(1 + 60a) \\ R_t &= R_0(1 + ta) \end{aligned}$$

Divide the first equation by the second, and solve for  $t$ , the value of which is found to be,

$$t = \frac{R_t(1 + 60a) - R_{60}}{R_{60} \times a}$$

Substitute the numerical values,  $R_{60} = 12$ ;  $R_t = 10$ ; and  $a = 0.004$  which will give the answer 8.33°C.

*Insulating Materials.*—The covering on the copper wires may consist of one, two, or three layers of cotton or silk. Silk coverings are used only on the smaller sizes, especially when it is important to economize space, that is to say, where the space

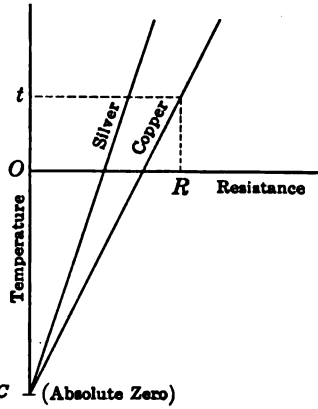

FIG. 14.—Diagram illustrating variation of resistance with temperature.

taken up by the cotton covering would be excessive in proportion to the cross-section of copper. When great economy of space is necessary, enamelled wire may be used. This is simply bare copper wire on which a thin coating of flexible enamel has been applied by a special process. Enamelled wire may often be used to advantage, especially in connection with the very small diameters; but there is always the possibility of contact between adjacent wires at abnormally high temperatures, and in

BELDENAMEL WIRE DATA

Nos. B. & S. gage	B. & S. sizes, bare (inches)	Increase thickness of enamel insulation	Allowable variation in thickness	Average diameter over enamel
13	0.0720	0.002	0.0005	0.074
14	0.0641	0.002	0.0005	0.0661
15	0.0571	0.002	0.0005	0.0591
16	0.0508	0.002	0.0005	0.0528
17	0.0452	0.0018	0.0004	0.047
18	0.0403	0.0018	0.0004	0.0421
19	0.0359	0.0018	0.0004	0.0377
20	0.0320	0.0018	0.0004	0.0338
21	0.0284	0.0017	0.0004	0.0301
22	0.0253	0.0016	0.0004	0.0269
23	0.0225	0.0015	0.0004	0.0240
24	0.0201	0.0014	0.0003	0.0215
25	0.0179	0.0013	0.0003	0.0192
26	0.0159	0.0012	0.0003	0.0171
27	0.0142	0.0011	0.0003	0.0153
28	0.0126	0.0010	0.0003	0.0136
29	0.0112	0.0009	0.0003	0.0121
30	0.0100	0.0008	0.0002	0.0108
31	0.0089	0.0008	0.0002	0.0097
32	0.0079	0.0007	0.0002	0.0086
33	0.0071	0.0007	0.0002	0.0078
34	0.0063	0.0006	0.0002	0.0069
35	0.0056	0.0006	0.0001	0.0062
36	0.005	0.0005	0.0001	0.0055
37	0.0044	0.0005	0.0001	0.0049
38	0.004	0.0004	0.0001	0.0044
39	0.0035	0.0004	0.0001	0.0039
40	0.0031	0.0004	0.0001	0.0035

many cases enamelled wire protected by a single covering of cotton has been used with very satisfactory results. In all cases when it is desired to save space by reducing the thickness of insulation on wires, the points to be considered are: (1) insulation; (2) durability; and (3) cost. The price of the silk covering is of course much higher than that of the cotton covering.

Enamel insulation does not add much to the diameter of the wire as will be seen by reference to the accompanying table based on data kindly furnished by the Belden Manufacturing Co. of Chicago. This wire will not suffer injury with the temperature maintained at 200°F. continuously, and it will withstand without breakdown a pressure of 900 volts per mil thickness of enamel; but on account of the possibility of abrasion during winding, a large factor of safety (not less than four) should be used, and indeed it is always advisable to place paper between the layers of enamelled wire, unless a careful study of the conditions appears to justify its omission. =====

Triple cotton covering can be used with advantage on the larger sizes of wire when the working pressure between adjacent turns exceeds 20 volts. When extra insulation is required between the *layers* of the winding, this is usually provided in the form of one or more thicknesses of paper or varnished cloth. It is the insulation between the finishing turns of a layer of wire and the winding immediately below which requires special attention, because this is where the difference of potential is greatest. One advantage of the ordinary cotton covering is that it lends itself admirably to treatment with oil or varnish, either before or after winding.

*Space Factor.*—The amount of space taken up by the insulation and the air pockets between wires of circular cross-section is important, because it reduces the cross-section of copper in the coil. If  $A$  is the cross-section of the copper, and  $A'$  the total area of cross-section through the winding, the ratio  $\frac{A}{A'}$  is called the space factor. The calculated space factor, based on the assumption of a known diameter over the insulation, and a close packing of the wires, does not always agree with the value obtained in practice, but the curves of Fig. 15 will be found to give good average values. It will be understood that the space factors of Fig. 15 include no allowance for extra insulation between layers of wire or for the necessary lining of the spool upon which the coil



is wound. If the number of turns per layer is very small, there will be an appreciable loss of space due to the turning back of the wire at the end of each layer.

*Insulation on Spools or Metal Forms.*—The materials used for insulating between the winding as a whole and any grounded metal by which it is supported include mica, micanite paper and cloth, pressboard, “presspahn,” varnished cambric, oiled linen

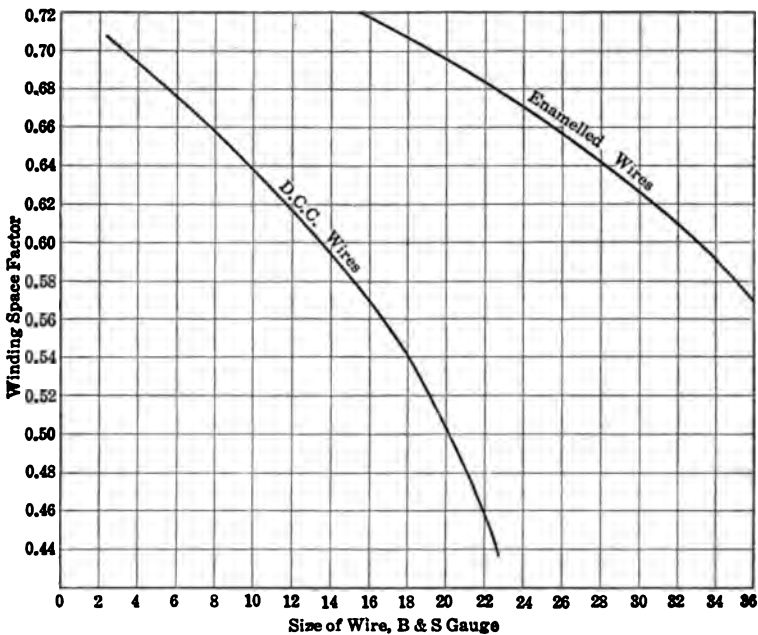

FIG. 15.—Space factors for wires of circular cross-section.

or cotton (empire cloth), cotton tape, etc. The voltage that some of these materials will withstand before breakdown is approximately as follows: empire cloth (usually 7 to 8 mils thick) will rarely puncture with less than 600 volts per mil; mica will withstand about 800 volts per mil; and micanite paper or cloth—which affords also an excellent mechanical protection—can generally be relied on to withstand 400 volts per mil. A large factor of safety is usually allowed, especially on the lower voltages. With a good quality of insulation, the total thickness between the cotton-covered wires and the supporting metal work should have the following values:

Up to 500 volts.....	0.045 in.
For 1,000 volts.....	0.060 in.
For 2,000 volts.....	0.080 in.
For 3,000 volts.....	0.10 in.

For higher pressures, up to 12,000 volts, add 0.03 in. per 1,000 volts increase.

**10. Calculation of Magnet Windings.**—The calculation of the ampere-turns necessary to produce a given flux of magnetism has already been explained (see Arts. 3 and 4), and it is a fairly simple matter to determine the exciting force approximately, provided the magnetic circuit consists mainly of iron of known magnetic characteristics, and that the air gaps are short. These calculations will be more fully illustrated when working out one or two numerical examples; but for the present it is

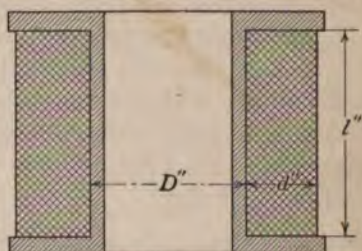

FIG. 16.—Cylindrical magnet coil.

assumed that a definite number of ampere-turns,  $SI$ , have to be wound on a bobbin or former, and that the applied D.C. potential difference,  $E$ , is known.

If  $SI$  = the total ampere-turns in the coil shown in Fig. 16, then, whatever may be the number of the turns  $S$ , the total ampere-wires in the cross-section  $d \times l$  is ( $SI$ ). For a first approximation of the area required, it is well to assume a certain current density in the windings, which is not likely to cause an excessive heat loss and therefore an unsafe rise of temperature. The following figures may be used:

For large magnets try  $\Delta = 700$ , or  $(M) = 1,800$

For medium-sized magnets try  $\Delta = 900$ , or  $(M) = 1,400$

For small magnets try  $\Delta = 1,100$ , or  $(M) = 1,150$

where  $\Delta$  = current density in amperes per square inch, and  $(M)$  = number of circular mils per ampere. The relation between these quantities, as previously explained (Art. 9) is,

$$\Delta \times (M) = 1.273 \times 10^6$$

By assuming the current density, it is then easy to calculate the probable cross-section of the copper in the coil. This, however, is not equal to the product  $d \times l$  because the winding space factor

must be taken into account. A little practice will enable the designer to form a rough idea as to the size of wire that will be required, this being of small diameter for high voltages and of large diameter for low voltages. He can select a probable value of the space factor from the curves of Fig. 15. The cross-section of the coil can now be calculated because,

$$l \times d = \frac{SI}{\Delta \times sf} \quad (25)$$

Any convenient relation between  $l$  and  $d$  may be chosen, but the value of one of these dimensions is usually decided upon in the first instance. It is well to avoid making the depth of winding,  $d$ , more than 3 in., even in large magnets, because the internal temperature is then liable to become excessive.

The size of the wire will depend upon the length of the mean turn; and, with a known value for  $d$ , and a core of circular cross-section, we have:

$$\text{Mean length per turn} = \pi(D + d) \text{ in. (See Fig. 16.)}$$

Applying formula (21) for the resistance of a copper wire at a temperature of about 60°C., we may write,

$$\text{resistance} = \frac{\text{length in inches}}{(m)} = \frac{E}{I}$$

whence

$$\frac{\pi(D + d)S}{(m)} = \frac{E}{I}$$

and

$$(m) = \frac{\pi(D + d) \times SI}{E} \quad (26)$$

In this manner the size of the wire can be determined. It should be noted that, for a given excitation, its cross-section depends only upon the applied potential difference and the average length per turn; it is quite independent of the number of turns of wire,  $S$ . That this must necessarily be the case is seen when it is realized that for every increase in  $S$ , the resistance increases in like manner, causing the current  $I$  to decrease by a proportional amount.

By referring to a wire table such as those on pages 34 and 35, the standard gage size nearest to the calculated cross-section can be chosen. If it does not seem close enough to the required size for practical purposes, the coil can be wound with two sizes

of standard wire, as will be explained shortly, but it is generally possible to modify the average length per turn and so obtain the desired result. The formula (26) can be written,

$$(D + d) = \frac{E(m)}{\pi \times SI}$$

whence

$$d = \frac{E(m)}{\pi \times SI} - D$$

Now, if ( $A$ ) is the area in circular mils of the standard size of wire it is proposed to use—instead of the previously calculated cross-section ( $m$ )—the required ampere-turns can be obtained by making the depth of winding,

$$d_1 = \frac{E(A)}{\pi \times SI} - D \tag{27}$$

Now estimate (by using the space factor curves, or by calculation) the number of turns required to fill the spool to the required depth, and calculate the total resistance,  $R$ , and the current,

$$I = \frac{E}{R}$$

A convenient rule, which usually provides sufficient winding space to prevent excessive temperature rise, is to allow 1 sq. in. of winding space cross-section for every 500 ampere-turns required on the coil. This simply means that the product  $\Delta \times sf$  of formula (25) is taken as 500.

*Winding Shunt Coils With Two Sizes of Wire.*—For a definite mean length per turn, the exact ampere-turns required on a magnet can always be obtained with standard sizes of wire by

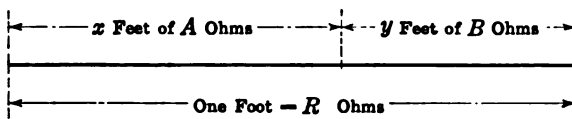

FIG. 17.—Two sizes of wire in series.

using, if necessary, two wires of different diameter connected in series or in parallel. The series connection is most usual for magnets or field coils to be connected across a definite voltage.

Let  $R$  stand for the ohms per foot length of wire to give the required excitation at the proper temperature;  $A$  = ohms per foot, at the same temperature, of the standard wire of larger size;

and  $B$  = the corresponding resistance of the smaller standard size of wire. It is proposed to make up the resistance  $R$  by connecting  $x$  feet of  $A$  ohms per foot in series with  $y$  feet of  $B$  ohms per foot, as indicated in Fig. 17. Thus,

$$xA + yB = R$$

also

$$x + y = 1 \quad \text{or, } y = 1 - x$$

whence

$$xA + B - xB = R$$

and

$$x = \frac{R - B}{A - B} \quad (28)$$

If it is preferred to work with cross-sections in circular mils, instead of resistances in ohms per foot, we can put the relation of formula (28) in the form

$$\begin{aligned} x &= \frac{\frac{1}{(m)} - \frac{1}{(B)}}{\frac{1}{(A)} - \frac{1}{(B)}} \\ &= \frac{(A)}{(m)} \times \frac{(B) - (m)}{(B) - (A)} \end{aligned} \quad (29)$$

where  $(m)$  = calculated circular mils,

$(A)$  = circular mils of larger standard wire,

$(B)$  = circular mils of smaller standard wire.

When winding with two sizes of wire in series, it is usual to put the smaller wire on the outside where the heat will be most readily dissipated.

**11. Heat Dissipation—Temperature Rise.**—The winding, if calculated as explained in the preceding article, will furnish the required excitation; but it is possible that the estimated value for the current density may result in a temperature so high as to injure the insulation, or so low as to render the cost of the magnet—owing to excess of copper—commercially prohibitive. The highest temperature will be attained somewhere inside the coil, and it is not easily calculated; the temperature as measured by a thermometer on the outside of the coil is only a rough guide to that of the hottest part. The *average* temperature is also higher than the outside temperature; it can be ascertained by measuring the resistance of the coil hot and cold. The maximum temperature can be measured only by burying thermometers or



test resistances in the center of the coil when it is being wound. The depth of winding has much to do with the relation between outside and inside temperatures. This depth should rarely exceed 3 in., and a long coil of small thickness will, obviously, have a much more uniform temperature than a short thick coil of the same number of turns.

As a rough indication of what may be expected in the matter of internal temperatures, it may be stated that, in magnet coils of average size, the mean temperature might be 1.4 times, and the maximum temperature 1.65 times, the external temperature. The maximum allowable safe temperature for cotton-covered wires is 95°C., and as this may be reached when the outside temperature is 40°C. above that of the surrounding medium, a maximum rise of temperature of 40° or 45°C., as measured at the hottest accessible part of the finished coil, is usually specified. If the calculated temperature rise is in excess of this, the coil must be re-designed in order to increase the cooling surface or reduce the  $I^2R$  loss.

The calculation of temperature rise is based largely upon coefficients which are the result of tests, preferably conducted on coils of the same type and size as the one considered. The cooling surface of a magnet winding of the type shown in Fig. 16, page 41, may be taken as the outside cylindrical surface only; or this outside surface *plus* the area of the two ends; or, again, the whole surface, not omitting the inside portion in proximity to the iron of the magnet core. This is largely a matter of individual choice based on experience gained with similar types of coil, and the heating coefficient will necessarily have a different value in each case.

The watts lost amount to  $I^2R$ , or  $EI$ , or  $\frac{E^2}{R}$ . The heating coefficient is the cooling surface necessary to dissipate one watt per degree difference of temperature between the outside of the winding and the surrounding air. Thus

$$k = \frac{TA}{I^2R}$$

and

$$T = k \frac{I^2R}{A} \quad (30)$$

where  $T$  is the temperature rise in degrees Centigrade;  $k$  is the heating coefficient, which can, if preferred, be properly defined

as the degrees Centigrade rise in temperature when the loss in watts is equal to the cooling surface in square inches; and  $A$  is the actual cooling surface expressed in square inches. The area of this cooling surface will be reckoned as the sum of the outside and inside perimeters multiplied by the length of the coil, *plus* the area of both ends of the coil. The temperature rise is found to differ very little whether the coil is surrounded entirely by air, or provided with an iron core, and for this reason the writer prefers to consider the total external area of the coil as the cooling surface.<sup>1</sup>

The heating coefficient  $k$  is not a constant, even for a given size and shape of magnet. It is a function of the difference of temperature between the coil surface and the surrounding medium; it also depends upon the material of the spools or bobbins, on the insulating varnish and wrappings (if any), and other details of construction. Assuming a surface temperature rise of about 40°C. and open type coils—that is to say, coils with ends and outside surface exposed to the air—finished with a coat or two of varnish over the cotton-covered wire, the coefficient  $k$  might lie between 160 and 200, with an average value of 180. With a temperature rise of only 20°C. the average value of  $k$  should be taken as 190.

In the case of iron-clad coils such as those found in many designs of lifting magnets and magnetic clutches, the final internal temperature will depend largely on the shape and thickness of the surrounding iron, and on the total radiating surface; but, for approximate calculations, the same coefficient may be used as for the open coils, bearing in mind that, in all cases, the temperature rise  $T$  of formula (30) is that of the outside layer of wire, and the area  $A$  is that of the total external surface of the copper coil.

**12. Intermittent Heating.**—Without attempting to discuss exhaustively the effects of intermittent service, the two extreme cases may be considered: (*a*) the apparatus is alternately carrying the full current, and carrying no current, during *short* periods of time extending over many hours, so that the total cooling surface is the factor of importance; and (*b*), the apparatus is in use at

<sup>1</sup> This is the recommendation of Mr. G. A. LISTER in his excellent paper published in the *British Journal*, Inst. E. E., vol. 38, p. 402, to which the reader is referred if he wishes to pursue further the subject of magnet-coil heating.

only rare intervals of time, with long periods allowed for cooling, so that the factor of importance is the capacity for heat.

*Case (a).*—During a period of 1 hr., the current is passing through the magnet coil for a known short interval of time, and is then switched off for another known period, so that out of a total of 60 min., the current flows through the coil during  $h$  min. only; the temperature rise can then be calculated, as previously explained, by making the assumption that the watts to be dissipated are not  $W = I^2R$ ; but  $W_h = \frac{I^2R \times h}{60}$ .

This method cannot safely be used if the “on” and “off” periods are long; but no general rule can be formulated in this connection because the size of the magnet is an important factor.

*Case (b).*—If used only at rare intervals of time, with long periods allowed for cooling down, a magnet coil can be worked at very high current densities. The temperature rise is then determined solely by the specific heat of the copper, and its total weight or volume.

The specific heat of a substance is the number of calories required to raise the temperature of 1 gram, 1°C. The specific heat of water at ordinary temperatures being taken as unity, that of copper is about 0.09. One calorie will raise 1 gram of water 1°C.; and since 1 calorie is equivalent to  $42 \times 10^6$  ergs (or dyne-centimeters), it follows that, to raise 1 gram of copper 1°C. in 1 sec., work must be done at the rate of  $0.09 \times 42 \times 10^6$  ergs per second. But 1 watt is the rate of doing work equal to  $10^7$  ergs per second; and 1 lb. = 453.6 grams; this leads to the conclusion that the power to be expended to raise 1 lb. of copper 1°C. in 1 sec. is

$$\frac{0.09 \times 42 \times 10^6 \times 453.6}{10^7} = 171.5 \text{ watts.}$$

A cubic inch of copper weighs 0.32 lb., and ( $173 \times 0.32$ ) or 55 watts will therefore raise the temperature of 1 cu. in. of copper 1°C. in 1 sec.—assuming no heat to be radiated or conducted away from the surface of the coil.

In this manner it is possible to calculate how long an electro-magnet for occasional use can be left in circuit without damage to insulation. A temperature rise of 50° to 55°C. is generally permissible in making calculations on the heat-capacity basis.



## CHAPTER III

### THE DESIGN OF ELECTROMAGNETS

**13. Introductory.**—The object of this chapter is partly to summarize and coördinate what has already been discussed; but mainly to familiarize the reader with the laws of the magnetic circuit and the simple computations which will enable him to proportion the iron cores and calculate the field windings of electric generators. A little practice in the design of the simple forms of lifting magnet, or magnetic brake, will be of the greatest value in illustrating the practical application of the fundamental principles underlying the design of all electromagnetic machinery. The designer who wishes to specialize in lifting magnets, magnetic clutches, and electromagnetic mechanisms generally, must pursue his studies elsewhere: he is referred to other sources of information such as MR. C. R. UNDERHILL'S book on electromagnets.<sup>1</sup> There are many matters of interest, such as the means of obtaining quick, or slow, action in magnets; equalizing the pull over long distances; special features of alternating-current electromagnets; and the mechanical devices introduced to attain specific ends, but none of these can receive adequate attention here.

In the design of electromagnets with movable armatures or plungers, the work to be done is usually reckoned as the *initial* or *starting* pull, in pounds, multiplied by the travel, in inches. Many designs, of varying sizes and costs, can be made to comply with the terms of a given specification, and the main object of the designer should be to put forward the design of lowest cost which will fulfil the conditions satisfactorily. It is not proposed to devote much space, either here or elsewhere, to the detailed discussion of the commercial aspects of design; but it is well to emphasize the fact that a designer who does not constantly bear in mind the factors of first cost and cost of upkeep, is of little or no value to the manufacturer. In the design of electromagnets, especially of the larger sizes, the material

<sup>1</sup> "Solenoids, Electromagnets and Electromagnetic Windings:" D. VAN NOSTRAND Co.

cost is the main item, and the total cost of iron and copper is a good guide to the cost of the finished magnet, when it is desired merely to compare alternative designs based on a given specification.

It is an easy matter to estimate the volume and weight of materials in so simple a design as a lifting magnet, and although formulas can be developed which aim to give the proportions and sizes for the most economical design, these are usually of doubtful value, and it is generally simpler to apply a little common sense and the engineering judgment which will come with practice, and try two or three designs with different proportions before selecting the one that seems most suitable in all respects, not omitting the important item of initial cost.

**14. Short-stroke Tractive Magnet.**—With a design of plunger magnet as shown in Fig. 18, there is not much magnetic leakage,

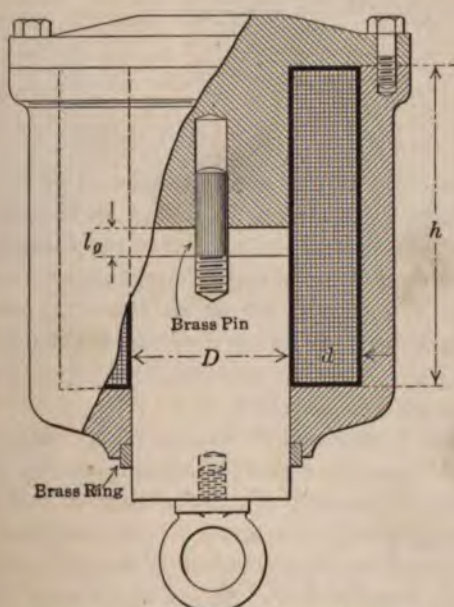

FIG. 18.—Plunger or iron clad magnet.

because the travel of the plunger, or length of air gap, is small in comparison with the area of the pole faces. Given a definite total amount of flux to produce the required pull, the cross-section of the various parts of the magnetic circuit is readily calculated.

Various proportions can be tried, also different values of the magnetic density in the air gap. The pull per square inch depends upon  $B^2$ ; but, by forcing the density up to high values, the ampere-turns required become excessive, and the weight and cost of the copper coils, prohibitive. More will be learned by trying various proportions and roughly estimating the cost, than by a lengthy discussion of the manner in which the various dimensions are dependent upon each other. It will probably be found that the most economical initial density will not exceed 11,000 gausses; and (by formula 16, Art. 8) the pull, in pounds per square inch, is

$$\frac{(11,000)^2}{1,730,000} = 70 \text{ lb.}$$

thus, with the usual cylindrical core,

$$\begin{aligned} \text{total force, in pounds} &= F = 70 \frac{\pi d^2}{4} \\ &= 55d^2 \end{aligned}$$

whence

$$d = 0.135 \sqrt{F} \quad (31)$$

The magnet can now be sketched approximately to scale, and the necessary ampere-turns computed, all as previously explained in Art. 4. Although Fig. 18 shows a very short air gap, the same methods apply to the calculation of magnets with longer air gap, provided this is not so great as to cause excessive magnetic leakage. A practical rule which determines the minimum length of the winding space is that this length,  $h$ , should never be less than twice the air-gap length,  $l$ .

**15. Magnetic Clutch.**—The design of a magnetic clutch to transmit power between a shaft and pulley or any piece of rotating machinery, is generally similar to that of the circular type of lifting magnet. Fig. 19 shows a common type of magnetic clutch with conical bearing surfaces, although the conical shape is not essential, and the wedge action of the cone-shaped rings is not relied upon to increase the pressure between the surfaces in contact. When the two iron surfaces are held together by the action of the exciting coil, the flux density over the area between the two annular pole faces must be such as to produce a force that will prevent slipping between these faces. A factor of safety of 2.5 to 3 is generally allowed.

Let  $R$  = mean radius, in feet.

$A$  = area of all North, or of all South, polar surfaces in contact (square inches).

$P$  = pressure in pounds per square inch of contact surface.

$N$  = revolutions per minute.

$c$  = coefficient of friction, the meaning of which is that  $c \times PA$  is the tangential force which will just produce slipping.

then

$$\text{hp.} = \frac{PA \times c \times 2\pi R \times N}{33,000} \quad (32)$$

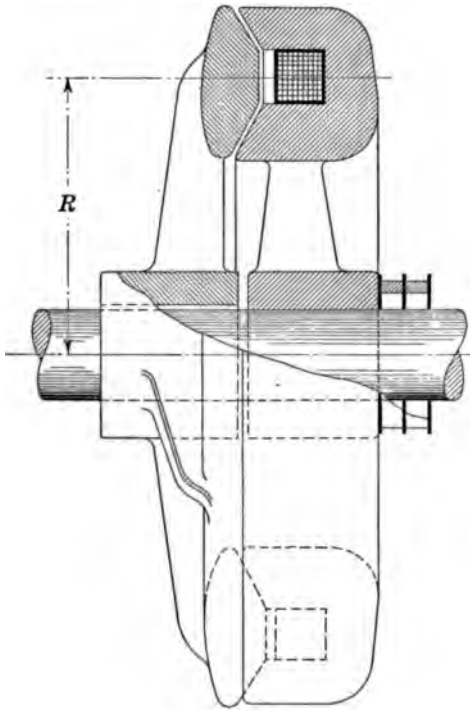

FIG. 19.—Magnetic clutch.

which gives the horsepower that the clutch will transmit just before slipping occurs. If  $k$  is the safety factor, and (hp.) is the horsepower which has to be transmitted, the value of hp. to insert in formula (32) should be (hp.)  $\times k$ . Note also that

$$P = \frac{B^2}{1,730,000}$$

and different values of  $B$  can be tried; these

values should be fairly high, but they will depend upon whether the magnetic circuit is of cast iron or steel. The unknown quantities are then  $R$  and  $A$ , and equation (32) can be put in the form

$$\begin{aligned} R \times A &= \frac{33,000 \times (\text{hp.}) \times k \times 1,730,000}{2\pi NCB^2} \\ &= \frac{91 \times 10^8 \times (\text{hp.}) \times k}{NCB^2} \end{aligned} \quad (33)$$

where  $B$  is in gausses, and the coefficient of friction,  $c$  (for dry surfaces), may be taken from the accompanying table. If the surfaces are lubricated with oil or grease, the friction coefficient may be lowered as much as 40 per cent. One reason for using a large factor of safety is to allow for the possibility of dirt or oil getting between the surfaces in contact.

TABLE GIVING APPROXIMATE VALUES OF THE COEFFICIENT OF FRICTION,  $c$

Pressure, lb. per sq. in.	Wrought iron on wrought iron	Wrought iron on cast iron	Cast iron on steel	Cast iron on cast iron
50	0.151	0.182	0.188	0.113
100	0.187	0.222	0.237	0.140
150	0.217	0.254	0.275	0.165
200	0.259	0.280	0.304	0.190

The formula (33) permits of either quantity  $R$  or  $A$  being calculated when one of them is known or assumed. It is the business of the designer to determine—usually by trial—the dimensions which will give the best results. So far as cost is concerned, a large diameter may show a saving in materials; but the labor cost—not omitting the cost of patterns when but few castings are required—should also be considered.

At times when slipping occurs, as in a magnetic brake, or when throwing in a magnetic clutch while there is some relative movement between the two parts, there is a powerful retarding, or driving, action as the case may be, due not to the direct magnetic pull between the surfaces in contact, but to the fact that eddy currents are produced in the polar faces on account of the cutting of the magnetic lines. This cutting of flux is similar to what occurs in the unipolar, or so-called homopolar, type of D.C. generator, where the currents are confined to certain paths and collected by means of sliding brushes.

## NUMERICAL EXAMPLES

**16. Horseshoe Lifting Magnet.**—Assume the specified conditions to be as follows:

Initial pull = 200 lb.

Travel of armature (being the length of the single air gap) = 0.35 in.

D.C. voltage = 110.

Allowable temperature rise = 40°C.

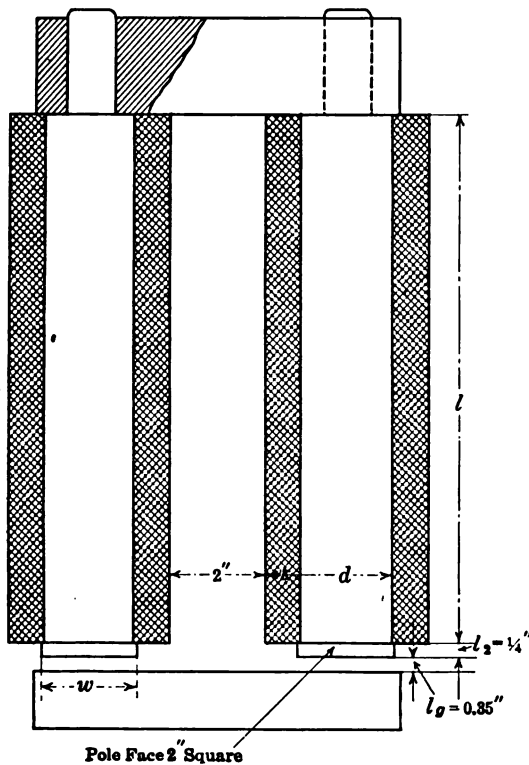

FIG. 20.—Horseshoe magnet.

The temperature to be taken on the outside surface of the exciting coils, after a sufficient time has elapsed for the final temperature to be reached.

The required magnet might be generally as shown in Fig. 20, where the iron limbs are of circular section with square pole pieces. These limbs may be steel castings, or they can be turned down from square bar iron. Cast iron would not be a suitable material,

because the large cross-section necessary to keep the flux density within reasonable limits would lead to an unnecessary and wasteful increase in the weight of the copper coils.

Applying formula (16) of Art. 8, page 29, the pull, expressed in terms of the air-gap density is

$$P = \frac{2AB^2}{1,730,000} \text{ lb.}$$

where  $B$  is in gausses, and  $A$  is the area of *one* polar face, expressed in square inches. Thus,

$$200 = \frac{2w^2B^2}{1,730,000}$$

whence,

$$w = \frac{13,150}{B} \tag{34}$$

This relation between size of pole face and the air-gap density must exist if the pull of 200 lb. is to be obtained, but the density  $B$  can be varied within wide limits. It is obvious that high values of  $B$  are advantageous in so far as they reduce the weight and cost of the iron in the magnet; but since the initial air-gap length remains constant, the necessary ampere-turns will increase almost in direct proportion to any increase of  $B$ . The economical value of the flux density,  $B$ , cannot be immediately determined; and although formulas for minimum cost can be developed, they become unwieldy and unpractical when all the important factors are taken into account. On the other hand, if all determining factors—including such items as cooling surfaces and magnetic leakage—are not taken into consideration, the formulas are very inaccurate and not of general application. It is very interesting to develop approximate formulas for use in arriving at the economical dimensions of any particular type of electromagnetic apparatus, and the reader may learn much by trying to put the various, and frequently conflicting, requirements in the form of a mathematical equation; but we shall follow here the method adopted by a large number of experienced designers, which consists in trying what seems a probably value for one of the unknowns, and then checking results by assuming a larger and a smaller value for the unknown quantity.

Since very low values of  $B$  will lead to great weight of iron, and very high values will lead to an increased weight of copper, it is safe to assume that  $B$  will not be less than 5,000 or more than



10,000 gausscs. We shall select the value of 7,000 for a trial design, and carry this through to completion, although it would usually be preferable to carry at least three designs through to the point where it becomes clear that one of these is distinctly preferable to the others from the point of view of economy; this being the main consideration which the designer must always bear in mind.

Putting for  $B$ , in formula (34), the value 7,000 gausscs, the side  $w$  of the (square) pole shoe is found to be 1.88 in. Let us make this 2 in.; whence  $B = \frac{13,150}{2} = 6,570$ . The thickness  $l_2$  of the pole shoe must be small in order to keep down the magnetic leakage; a value of  $\frac{1}{4}$  in. for  $l_2$  should be satisfactory.

The diameter,  $d$ , of the magnet cores under the winding is obtained by assuming a leakage factor and a suitable flux density in the iron. The leakage factor (refer Art. 7, page 28, for definition) might be about 1.5 in a magnet of this type and size; and the density in the core of magnet steel or wrought iron, may be as high as 90,000 lines per square inch. Thus;

$$\frac{\pi}{4} d^2 = \frac{1.5 \times 4 \times 6,570 \times 6.45}{90,000}$$

whence  $d = 1.9$  or (say)  $d = 1.875$  in.

Summing up the quantities so far determined, we have:

$$w = 2 \text{ in.}$$

$$l_2 = \frac{1}{4} \text{ in.}$$

$$d = 1\frac{7}{8} \text{ in.}$$

$$B \text{ (air-gap density)} = 6,750 \text{ gausscs.}$$

$$\Phi \text{ (useful or effective flux per pole)} = 6,750 \times 6.45 \times 2 \times 2 \\ = 174,000 \text{ maxwells.}$$

*Depth of Winding.*—The length  $l$  of the winding space, and the thickness of winding,  $t$ , will depend upon the ampere-turns necessary to produce the desired flux density in the air-gap, and also upon the allowable current density,  $\Delta$ , in the copper of the exciting coils. The relation of  $l$  to  $t$  is not determined by the amount of the ampere-turns, since this only calls for a sufficient cross-section, or product  $l \times t$ . The thickness  $t$  should not exceed 3 in., because a greater thickness may lead to excessive temperatures inside the coil; but the most suitable dimensions of the coil are really determined by the current density, the winding space factor, and the cooling surface necessary to prevent



excessive temperature rise. It is usual to assume a value for the thickness,  $t$ , which may be something more than one-third of the diameter of the core, with the previously mentioned limit of about 3 in. Thus, even if  $d$  were greater than 9 in., the depth of winding should, preferably, not exceed 3 in. In the present case  $t$  should be about  $1.875 \div 3 = 0.625$  in. Let us try  $t = \frac{3}{4}$  in.

*Current Density in Windings.*—If a suitable value for the current density in the windings can be chosen, it will be an easy matter to determine the length,  $l$ , of the winding space, and so complete the preliminary design.

Let  $\Delta$  = the current density (amperes per square inch).

$R''$  = the resistance, in ohms, between opposite faces of an inch cube of copper. By formula (29) of Art. 9,

$$R'' = \frac{1}{1,273,000} \text{ at } 60^{\circ}\text{C.}$$

$sf$  = the winding space factor, as given in Fig. 15, page 40. As the size of wire is not yet known, a probable value of 0.5 will be chosen for this factor, in the preliminary calculations.

$T$  = the allowable temperature rise, being  $40^{\circ}\text{C.}$  in this example.

$k$  = the cooling coefficient, being defined in Art. 9 formula (30), as  $T \times \frac{\text{cooling surface}}{\text{watts to be dissipated}}$ . An average value of 180 may be taken for  $k$ .

Equating the  $I^2R$  losses with the watts that can be dissipated without exceeding the temperature limit, we can write,

$$\begin{aligned} \text{total surface of coil} \times \frac{T}{k} &= \text{watts lost} \\ &= R'' \Delta^2 \times \text{cubic inches of copper} \end{aligned}$$

or

$$\frac{T}{k} [2l\pi(d+t) \times 2 + 4t\pi(d+t)] = R'' \Delta^2 \times 2lt\pi(d+t) \times sf$$

whence

$$\Delta = \sqrt{\frac{2T(l+t)}{kR''l \times sf}} \quad (35)$$

In order to eliminate  $l$ , we may consider  $t$  in the numerator to be negligible, since, in this particular design, with an air gap of

considerable reluctance,  $t$  will be small in comparison with  $l$ . The approximate value of  $\Delta$  will then be,

$$\begin{aligned}\Delta \text{ (approx.)} &= \sqrt{\frac{2T}{kR''t \times sf}} & (36) \\ &= \sqrt{\frac{2 \times 40 \times 1,273,000}{180 \times 1 \times 0.75 \times 0.5}} \\ &= \text{(say) } 1,250\end{aligned}$$

— *Length of Winding Space.*—The ampere-turns required for the double air-gap only, *i.e.*, not including those required to overcome the reluctance of the iron portions of the magnetic circuit, will be, by formula (5) of Art. 4,

$$\begin{aligned}(SI)_g &= 2.02B \times 2l_g \\ &= 2.02 \times 6,570 \times 2 \times 0.35 \\ &= 9,300.\end{aligned}$$

The ampere-turns for the iron part of the magnetic circuit cannot be calculated accurately until the length  $l$  and the actual leakage factor have been determined; but, since the air-gap, in this case, offers far more reluctance than the remaining portions of the magnetic circuit, we shall assume the iron portions to require only one-tenth of the air-gap ampere-turns. Thus,

$$\text{total } SI \text{ (both spools)} = 10,230 \text{ approx.}$$

We are now able to solve for the length of the winding space, which is,

$$\begin{aligned}l &= \frac{SI \text{ total}}{2t\Delta \times sf} \\ &= \frac{10,230}{2 \times 0.75 \times 1,250 \times 0.5} \\ &= 10.9 \text{ or (say) } 11 \text{ in.}\end{aligned}$$

Before proceeding further with the design, it will be well to see whether the long magnet limbs will not be the cause of too great a leakage flux. If the leakage factor is much in excess of the assumed value (1.5) there is danger of saturating the cores under the windings, and so limiting the useful flux available for drawing up the armature. Let the distance between the windings be 2 in., as indicated on Fig. 20; this gives all necessary dimensions for calculating the permanence of the leakage paths.

*Calculation of Leakage Flux.*—The total leakage flux between

the two magnet limbs should be considered as made up of two parts:

(a) The flux leakage from pole shoe to pole shoe, which is due to the total m.m.f., available for the air gap.

(b) The flux leakage between the circular cores under the windings, which increases in density from the yoke to the pole pieces and is equal to the *average* m.m.f.  $\times$  the permeance of the air paths between the two iron cylinders. This average m.m.f. will be approximately *one-half* the total m.m.f. of the exciting coils.

For the permeance of the paths comprised under (a), we have:

1. Between opposing rectangular faces,

$$P_1 = \frac{6.45 \times 2 \times 0.25}{2.54 \times 3.375} = 0.376$$

2. Between the two pairs of faces parallel to the plane of the paper (Fig. 20), by formula (10) Art. 5,

$$\begin{aligned} P_2 &= 2 \frac{l}{\pi} \log_e \left( \frac{\pi t + s}{s} \right) \\ &= 2 \times \frac{0.25 \times 2.54}{\pi} \times 2.3 \log_{10} \left( \frac{\pi \times 2 + 3.375}{3.375} \right) \\ &= 0.425. \end{aligned}$$

Neglecting the flux lines that may leak out from the pole faces farthest removed from each other, and also those between the small ledges caused by the change from square pole piece to circular section under the coil, the total leakage flux between pole pieces is

$$\begin{aligned} \Phi_p &= \text{m.m.f.} \times (P_1 + P_2) \\ &= 0.4\pi \times 9,300 \times 0.801 \\ &= 9,350 \text{ maxwells.} \end{aligned}$$

The permeance of the air paths comprised under (b) may be calculated by applying formula (13) of Art. 5. Thus,

$$P_3 = \frac{\pi \times 11 \times 2.54}{2.3 \log_{10} \left( \frac{1.875}{3.5 + 1.875 - \sqrt{(3.5)^2 + (2 \times 3.5 \times 1.875)}} \right)} = 51$$

The leakage flux between magnet cores under the windings is,

$$\begin{aligned} \Phi_c &= \frac{\text{m.m.f.}}{2} \times P_3 \\ &= \frac{0.4\pi \times 10,230}{2} \times 51 \\ &= 330,000 \text{ maxwells} \end{aligned}$$

and the total leakage flux is

$$\Phi_l = 9,350 + 330,000 = 339,350 \text{ maxwells.}$$

The leakage factor is

$$\frac{170,000 + 339,350}{170,000} = 3 \text{ (approx.)}$$

which is greatly in excess of the permissible value, unless the cross-section of the core under the windings is increased to keep the flux density within reasonable limits. The simplest way to reduce the amount of the leakage flux is to shorten the magnet limbs, and although the long limbs with no great depth of winding may lead to economy of copper, it is seen to be necessary in this design to increase the depth of winding,  $t$ , in order to reduce the length,  $l$ , of the exciting coils. The dimension  $t$  will have to be more than doubled. Let us make this  $1\frac{3}{4}$  in. and at the same time retain the full section of 2 in. square under the windings; that is to say, the square section bar will be carried up through the coils without being turned down to a smaller section as in the trial design.

Using formula (36)<sup>1</sup> to calculate the current density, we have,

$$\begin{aligned} \Delta &= \sqrt{\frac{80 \times 1,273,000}{180 \times 1.75 \times 0.5}} \\ &= (\text{say}) 800 \end{aligned}$$

whence

$$\begin{aligned} l &= \frac{10,230}{2 \times 1.75 \times 800 \times 0.5} \\ &= 7.3 \text{ in.} \end{aligned}$$

Let us try  $l = 7$  in.

Allowing still a separation of 2 in. between the outside surfaces of the windings, the distance between the two parallel magnet cores of square section will now be 5.5 in. The permeance between the opposite faces is

$$P_1 = \frac{7.25 \times 2 \times 6.45}{5.5 \times 2.54} = 6.7$$

and between the sides of the magnet cores (by formula 10, page 25)

$$P_2 = 2 \times \frac{7.25 \times 2.54}{\pi} \times 2.3 \log_{10} \left( \frac{\pi \times 2 + 5.5}{5.5} \right) = 8.9$$

<sup>1</sup> This formula and also the correct formula (35) are applicable to rectangular as well as to circular coils.

The total leakage flux will be approximately

$$\begin{aligned}\Phi_l &= \frac{0.4\pi \times 10,230}{2} \times (6.7 + 8.9) \\ &= 100,000 \text{ maxwells.}\end{aligned}$$

This calculated value of the leakage flux should be slightly increased because the total permeance between the two magnet limbs will actually be greater than as calculated by the conventional formulas. Let us assume the total flux to be 125,000 maxwells. This makes the value of the leakage factor,

$$lf = \frac{170,000 + 125,000}{170,000} = 1.73$$

The maximum value of the density in the iron cores will be

$$\frac{170,000 + 125,000}{4} = 73,600 \text{ lines per square inch.}$$

*Closer Estimate of Exciting Ampere Turns.*—The modified magnet will now be generally as shown in Fig. 21. The ampere turns required to overcome the reluctance of the two air gaps have already been calculated; the remaining parts of the magnetic circuit consist of the two magnet limbs under the windings, together with the yoke and the armature. If we know the amount of the flux through the iron portions of the circuit we can readily calculate the flux density, and then ascertain the necessary m.m.f. to produce this density, by referring to the  $B$ - $H$  curves of the material used in the magnet.

In the magnet cores under the coils, the flux density varies from a minimum value near the poles to a maximum value near the yoke; and as the leakage flux is not uniformly distributed over the length  $l_c$  (Fig. 21), it would not be correct to base reluctance calculations upon the arithmetical average of the two extreme densities, even if the flux density were below the "knee" of the  $B$ - $H$  curve, with the permeability,  $\mu$ , approximately constant. With high values of  $B$ , the length of the magnetic core should be divided into a number of sections, and each section treated separately in calculating the required ampere-turns. With comparatively low densities, as in this example, the calculation can be made on the assumption of an average density in the magnet cores, the value of which is

$$B_c = \frac{2B_y + B_p}{3}$$

where  $B_y$  = flux density at end near yoke,  
and  $B_p$  = flux density at end near pole pieces.

The total ampere-turns for the magnet of Fig. 21 can now be calculated by using the  $B-H$  curve of Fig. 3 which is supposed to apply to the particular quality of magnet steel or iron which it is proposed to use. The calculation can conveniently be put in tabular form as shown below.

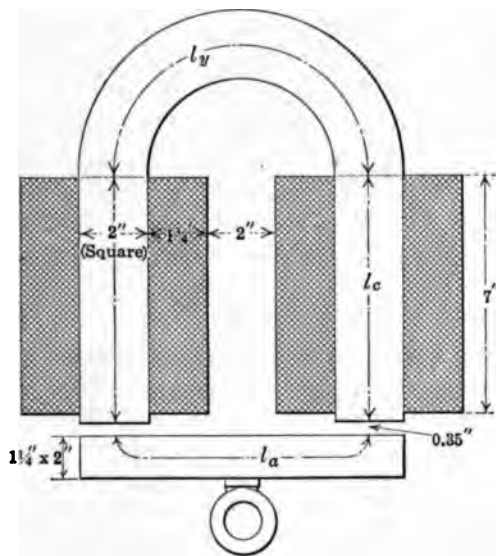

FIG. 21.—Horseshoe magnet. (Modified design.)

Part of circuit	Length, inches	Cross-section, square inch	Total flux, maxwells	Density, lines per square inch	SI per inch	SI, total
Air gaps.....	0.7	4.0	170,000	42,500	...	9,300
Armature.....	8.3	2.5	170,000	68,000	9.0	75
Magnet cores.....	14.5	4.0	220,000	55,000	7.5	110
Yoke.....	12.0	4.0	295,000	73,600	9.5	115
Total.....						9,600

Thus, it is necessary to have not less than 9,600 ampere-turns on the two bobbins.

*Calculation of Windings.*—The formula (26) of Art. 10 can be written,

$$(m) = \frac{\text{mean length of turn (inches)} \times SI}{E}$$

The mean length of turn is approximately  $4(w + t)$ , or  $4 \times 3.75 = 15$  in.; and the potential difference across the two coils is 110 volts; thus,

$$(m) = \frac{15 \times 9,600}{110} = 1,310$$

Referring to the wire table on page 34, the wire of cross-section nearest to the required value is No. 18 B. & S. gage, because No. 19 will be too small to provide the necessary excitation. This larger wire will provide a factor of safety, and it may be used if the watts lost and the temperature rise are not excessive.

*Calculation of Temperature Rise.*—The space factor for No. 18 B. & S. D.C.C. wire, as taken off the curve of Fig. 15, is 0.54. The cross-section of the copper in the coil is therefore  $7 \times 1.75 \times 0.54 = 6.62$ , and the number of turns per coil will be  $6.62/0.001276 = 5,180$ . Other required values are:

Length of wire in one coil =  $5,180 \times \frac{15}{12} = 6,500$  ft.

Resistance at 60°C. =  $6.5 \times 7.42 = 48.2$  ohms.

Current =  $\frac{55}{48.2} = 1.14$  amp.

Total  $I^2R$  loss =  $1.14 \times 110 = 125$  watts.

Outer surface of both coils =  $2 \times 7 \times 4 \times 5.5 = 308$

Inner surface of both coils =  $2 \times 7 \times 4 \times 2 = 112$

End surfaces of both coils =  $4 \times 1.75 \times 4 \times 3.75 = 105$

---

Total cooling surface..... = 525 sq. in.

The rise of temperature, by formula (30) Art. 11 taking  $k = 180$ , is

$$T = 180 \times \frac{.125}{525} = 43^\circ\text{C.}$$

which is only slightly in excess of the specified temperature rise (40°C.). Another layer or two of winding would bring the temperature down to the required limit; or, if preferred, the length of the coil may be increased by a small amount without appreciably adding to the reluctance of the magnetic circuit.

It should be mentioned that the design of magnet as shown in Fig. 21, is probably larger than would be necessary to fulfil practical requirements, because it is not likely that the full pressure of 110 volts would be maintained across the terminals



for many hours. The magnet would be designed either for intermittent operation, in which case the temperature rise might be calculated as in *Case (a)* of Art. 12, page 47, or, if left continuously in circuit, a resistance would automatically be thrown in series with the coil windings in order to reduce the  $I^2R$  loss and effect a saving of copper while still maintaining the required pull of 200 lb. through the reduced air gap.

*Factor of Safety.*—Seeing that the coils are actually wound with a wire of greater cross-section than the calculated value, the initial pull will be somewhat greater than the specified 200 lb. The actual ampere-turns are  $5,180 \times 2 \times 1.14 = 11,800$ , and since the density in the iron is not carried above the “knee” of the  $B$ - $H$  curve, the actual flux density in the air gap, instead of being 6,570 gaussess, will be approximately  $6,570 \times \frac{11,800}{9,600} = 8,070$  or (say) 8,000 gaussess. The initial pull will actually be  $200 \times \frac{(8,000)^2}{(6,570)^2} = 300$  lb. nearly. This factor of safety of 1.5 may seem excessive, and if the strictest economy of material is necessary, the coils should be wound with a wire of the calculated size, or, if standard gage numbers must be used, as would generally be the case, the mean length of turn may be modified by providing a greater or smaller depth of winding space. As an alternative, two sizes of wire may be used as explained in Art. 10.

*Most Economical Design.*—The cost of materials is easily estimated by calculating the weight of iron and copper separately. For the purpose of comparing alternative designs, it is usual to take the cost of copper as five times that of the iron parts of the magnet. If actual costs are required, the figures would be about 20c. per pound for copper wire, and 4c. per pound for the magnet iron.

The reader will recollect that this design has been worked through on the assumption that about 6,500 gaussess would be a suitable density in the air gap. If many magnets are to be made to the one design, or in any case if the magnet is large and costly, the designer should now try alternative designs, using air-gap densities of (say) 4,000 and 8,000 gaussess respectively. By comparing the three designs, all of which will comply with the terms of the specification, he will be able to select the one which can be constructed at the least cost. This method of working may seem slow and tedious, but it is sure, and—if actually tried—



will be found to involve less time and labor than might be supposed. The student following the courses at an engineering college does not—unless he has had outside experience—appreciate the value of his time. Time may be used, abused, or wasted; and when a concrete and definite piece of work has to be done, the time spent upon it, not only by the workman, but also by the designer, may be of no less, or even of greater, importance than the cost of the materials. The case in point exemplifies this. If the required magnets are small, and but two or three are likely to be wanted, the designer should not spend much time on refinements of calculation and in endeavoring to reduce the cost of manufacture to the lowest limit; but if the magnets are of large size and several hundred will be required, then time spent by the designer in comparing alternative designs and in striving to reduce material and labor cost, would be amply justified. These considerations and conclusions may, to many, appear elementary and obvious; but they emphasize the importance of what is generally understood by “engineering judgment” which is rarely acquired or rightly valued until after the student has left school.

Before taking up the design of another form of magnet, it may be well to state that the method of procedure here followed in the case of a horseshoe magnet is not put forward as being necessarily the best, or such as would generally be adopted by an experienced designer. It serves to illustrate much that has gone before, and emphasizes the fact that, even if the designer must make some assumptions and do a certain amount of guesswork at the beginning, and during the course, of his design, he can always *check* his results when the work is completed, and satisfy himself that his design complies with all the terms of the specification.

**17. Circular Lifting Magnet.**—The electromagnet of which Fig. 22 is a sectional view is circular in form. Its function is to lift a ball of steel weighing, say, 4,000 lb., which, on the opening of the electric circuit, will fall upon a heap of scrap iron. This device is referred to colloquially as a “skull cracker.” The diameter of a solid steel sphere weighing 4,000 lb. is approximately 30 in. If the outer cylindrical shell—forming one of the poles of the magnet—has an average diameter of 21 in., it will include an angle of 90 degrees, as indicated in Fig. 22, and lead to a design of reasonable dimensions. If the required width of

the annular surface forming the outer pole of the magnet should be less than 1 in., it might be necessary, for mechanical reasons, to reduce the diameter in order to obtain a practical design. The total pull required is 4,000 lb., or 2,000 lb. per pole. The pull per square inch of polar surface is, by formula (16) page 29.

$$\text{Pounds per square inch} = \frac{B^2}{1,730,000}$$

whence the area of each pole face is

$$A = \frac{2,000 \times 1,730,000}{B^2}$$

If  $B = 6,000$  gausses,  $A = 96$  sq. in.; and if  $B = 8,000$  gausses,  $A = 54$  sq. in. Either of these flux densities would probably

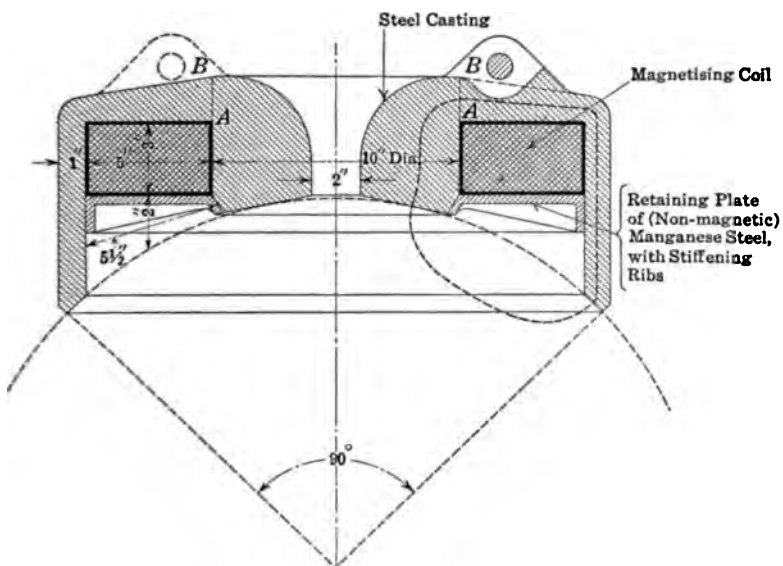

FIG. 22.—Circular lifting magnet.

be suitable for a magnet of the type considered. Assuming a minimum width of 1 in. for the pole face on the outer shell, we have,

$$\begin{aligned} \text{Area of outer ring} &= 1 \times \pi \times 21 \\ &= 66 \text{ sq. in.} \end{aligned}$$

which would provide the required pull if  $B = 7,240$  gausses.

Let us therefore decide upon this dimension. The diameter of the inner core is obtained from the equation

$$\frac{\pi}{4} D^2 = 66$$

whence  $D = 9.16$  in. It will be better to provide a 2-in. hole through the center of the magnet, and have a conical face to the core, as shown in sketch. The diameter of the central pole core may be 10 in., and the edges can be slightly bevelled off so that the polar surface shall not exceed 66 sq. in.

In order to introduce a factor of safety, and permit of the iron ball being lifted even when the contact between magnet and armature is imperfect, the specification would probably call for a magnet powerful enough to attract the ball through a distance of, say,  $\frac{1}{4}$  in. Let us further assume that, the action being intermittent, the current will flow through the exciting coil during only half the time that the magnet is in action. This will probably permit the use of a current density of 1,000 amp. per square inch of copper section. Thus, if the winding space factor may be taken as 0.5, it will be necessary to provide 2 sq. in. of cross-section of coil for every 1,000 ampere-turns of excitation required.

The ampere-turns necessary to overcome the reluctance of the double air gap are

$$\begin{aligned} {}^1(SI)_g &= 2.02B \times l''_g \\ &= 2.02 \times 7,240 \times \frac{1}{2} \\ &= (\text{say}) 8,000, \text{ which includes a small} \end{aligned}$$

allowance for the reluctance of the iron in the circuit. The required section of coil is therefore about 16 sq. in. One of the dimensions should, if possible, be kept within the limit of 3 in. in order to avoid excessive internal temperatures. A cross-section of 5 in. by 3 in. = 15 sq. in. will probably be large enough to accommodate the winding.

The average length per turn of wire is  $\pi(10 + 5) = 47.2$  in., and (by formula 26, Art. 10, page 42) the cross-section of the wire, in circular mils, will be

$$(m) = \frac{47.2 \times 8,000}{E}$$

where  $E$  is the voltage across the terminals of the magnet. Assuming this to be 120 volts, the value of  $(m)$  will be 3,140.

<sup>1</sup> Art. 4, formula (5).

Referring to the wire table on page 34, the calculated size is seen to be only slightly less than the cross-section of No. 15, B. & S. gage. Using this wire, and allowing  $\frac{1}{8}$  in. for insulation between the iron and the coil, there will be about 68 layers of 41 turns, making a total of, say, 2,800 turns in the coil. The length of wire will therefore be  $2,800 \times 47.2 \div 12 = 11,000$  ft., and the resistance hot, *i.e.*, at a temperature of  $60^{\circ}\text{C}$ ., will be  $3.702 \times 11 = 40.6$  ohms. The current =  $120/40.6 = 2.95$  amp. and the actual ampere-turns =  $2.95 \times 2,800 = 8,260$ .

*Rise of Temperature.*—The watts lost in the field when the current is flowing are  $EI = 120 \times 2.95 = 354$ ; but since the current is supposed to be passing through the windings during only one-half the time that the magnet is in operation, we can apply the rule referred to in Art. 12, and assume that the power to be dissipated amounts to only  $354/2 = 177$  watts. The total surface of the coil is  $47.2(10 + 6) = 755$  sq. in., and if we use the average value of 180 for the heating coefficient  $k$ , as suggested in Art. 11 page 46, the temperature rise will be

$$T = 180 \times \frac{177}{755} = 42.2^{\circ}\text{C}.$$

above the temperature of the air. This figure is a safe one, and, since the iron shell offers a large cooling surface in contact with the air, it is probable that the value of the coefficient  $k$  in this particular design might be about 250. The temperature of the windings will therefore not be excessive, and the amount of copper might even be slightly reduced if the greatest economy in manufacturing cost is to be attained. Exact data for the calculation of temperatures in coils entirely surrounded by iron are not available, because the thickness and radiating surface of the external shell are factors which will have an appreciable influence on the value of the heating coefficient.

*Calculation of Leakage Flux.*—In order to provide sufficient cross-section in the magnet, and ensure that the flux density in the iron shall not be carried too near the saturation limit, it is necessary to estimate the amount of the leakage flux.

The permeance of the leakage paths may be calculated by considering two separate components of the leakage flux: (1) the flux which passes between the core and the cylindrical shell through the space occupied by the windings, and (2) the flux which passes between the uncovered portions of the central core



and the outer shell. Referring to Fig. 22, upon which the approximate dimensions of the leakage paths have been marked, the numerical values of the two permeances are seen to be, approximately,

$$\text{for the path (1), } P_1 = \frac{3 \times \pi(10 + 5) \times 6.45}{5 \times 2.54} = 72$$

$$\text{for path (2), } P_2 = \frac{2 \times \pi(10 + 5) \times 6.45}{5.5 \times 2.54} = 43.5$$

The flux through path (1) is

$$\begin{aligned} \Phi_1 &= \frac{\text{m.m.f.}}{2} \times P_1 \\ &= \frac{0.4\pi \times 8,260}{2} \times 72 \\ &= 374,000 \end{aligned}$$

and the flux through path (2) is,

$$\begin{aligned} \Phi_2 &= \text{m.m.f.} \times P_2 \\ &= 0.4 \pi \times 8,260 \times 43.5 \\ &= 450,000 \end{aligned}$$

The total leakage flux is  $\Phi_1 + \Phi_2 = 824,000$  maxwells. The useful flux is  $66 \times 6.45 \times 7,240 = 3,080,000$  maxwells, and the leakage factor is

$$\frac{3,080,000 \times 824,000}{3,080,000} = 1.27$$

The flux density in the cylindrical outer shell, near the yoke, will be  $7,240 \times 1.27 = 9,200$  gaussess, and this will also be the density in the central pole if the cross-section is the same, but a higher density would be permissible. The section at every part of the magnetic circuit can be calculated on the basis of an assumed density. As an instance, if it is desired to have a density of 11,000 gaussess in the yoke at the section  $AB$ , the thickness of the casting at this point, as indicated by the length of the line  $AB$ , would be obtained from the equation

$$11,000 = \frac{3,080,000 \times 1.27}{AB \times \pi \times 10 \times 6.45}$$

whence  $AB = 1^3 \frac{1}{4}$  in.

In this manner the magnetic circuit may be proportioned. The path of the magnetic flux is indicated by the dotted lines in

Fig. 22, and since the cross-section and length of each part of the magnetic circuit are now known, the component of the total ampere-turns necessary to overcome the reluctance of the iron or steel casting can be calculated in the usual way. The reluctance of the steel sphere which constitutes the armature would be considered negligible in these calculations.

In a well-designed magnet of this type, the reluctance of the iron portions of the circuit is but a small percentage of the air-gap reluctance, unless the specified air gap is very small. When the armature is in contact with the pole faces, the total flux will be greater than the amount necessary to produce the required initial pull. It is interesting and instructive to calculate the pull between magnet and armature when the air gap is practically negligible. The limit is reached when all the exciting ampere-turns are required to overcome the reluctance of the iron, and the calculation has to be made by assuming probable values of the flux density, and then calculating the loss of magnetic potential across each portion of the circuit.

With reference to the important matter of cost; air-gap densities other than the assumed density of 7,240 gaussses may be tried with a view to obtaining the design of lowest first cost. A saving in copper may be effected by allowing the temperature rise to approach as nearly as possible the specified limit; but in this as in all economical designs of apparatus in which a saving in first cost is accompanied by a loss of efficiency in working, the interests of the user demand that proper attention be paid to the cost of operation (in this case of the  $I^2R$  losses) when considering the expediency of lowering the manufacturing cost by economizing in materials.

## CHAPTER IV

### DYNAMO DESIGN—FUNDAMENTAL CONSIDERATIONS. BRIEF OUTLINE OF PROBLEM

**18. Generation of E.m.f.**—It has been shown in previous chapters how the strength and amount of the magnetic field produced by an electric current may be calculated, and the next step in the development of the dynamo is to consider how the desired terminal voltage may be obtained by causing the armature conductors to cut the magnetic flux which crosses the air gap from pole to armature core.

The D.C. motor is merely a dynamo of which the action has been reversed; that is to say, instead of providing mechanical energy to drive the armature conductors through the magnetic field, an electric current from an outside source is sent through the armature winding which, by revolving in the magnetic field, converts electrical energy into mechanical energy. In the design of a D.C. motor, the procedure is exactly the same as for a D.C. generator, and in the following pages the dynamo will be thought of mainly as a generator.

Consider a flat coil of insulated wire of resistance  $R$  ohms, consisting of  $S$  turns enclosing an area of  $A$  square centimeters. Let this coil be thrust into, or withdrawn from, a magnetic field of density  $B$  gausses, the direction of which is normal to the plane of the coil. The quantity of electricity which will be set in motion is expressed by the formula

$$Q = \frac{BAS}{R}$$

a relation that can be proved experimentally.

But 
$$Q = I_m \times t = \frac{E_m}{R} \times t$$

where  $t$  = the time required to enclose or withdraw the flux ( $\Phi = BA$ ).

$I_m$  = the average value of the current in the coil during this period, and

$E_m$  = the average value of the e.m.f. causing the flow of electricity.



Hence

$$E_m = \frac{(BA) \times S}{t}$$

where all quantities are expressed in absolute C.G.S. units. If we put  $\Phi$  for the flux ( $BA$ ) in maxwells, and express the e.m.f. in the practical system of units, we have

$$E_m = \frac{\Phi \times S}{t \times 10^8} \text{ volts} \quad (37)$$

For the condition  $S = \text{unity}$ , this formula is clearly seen to express the well-known relation between rate of change of flux and resulting e.m.f., namely that *one hundred million maxwells cut per second generate one volt*. This is the fundamental law upon which all quantitative work in dynamo design is based. The procedure for obtaining a given amount of flux was explained in previous chapters, and we now see that the *voltage* of any dynamo-electric generator may be calculated by applying formula (37). For the rest, the electrical part of the designer's work consists in providing a sufficient cross-section of copper to carry the required current, and a sufficient cross-section of iron to carry the required flux, in order that the machine shall not heat abnormally under working conditions. There are other matters of importance such as regulation, efficiency, economy of material, and—in D.C. machines—commutation, which require careful study; but it is hardly an exaggeration to say that—apart from mechanical considerations, which are not dealt with in this book—the work of the designer of electrical machinery is based on two fundamental laws: (1) the law of the magnetic circuit, namely, that the flux is equal to the ratio of magnetomotive force to reluctance, and (2) the law of the generation of an e.m.f., namely, that one hundred million lines cut per second generate one volt.

At any particular moment it is the rate of change of the flux in the circuit that determines the instantaneous value of the voltage, or, in symbols,

$$\text{instantaneous volts in circuit of one turn} = - \frac{d\Phi}{dt} \times 10^{-8}$$

where the negative sign is introduced because the developed e.m.f. always tends to set up a current the magnetizing effect of which *opposes* the change of flux.

Consider a dynamo with any number of poles  $p$ . Fig. 23 shows a four-pole machine with one face-conductor driven

mechanically at a speed of  $N$  revolutions per minute through the flux produced by the field poles. If  $\Phi$  stands for the amount of flux entering or leaving the armature surface *per pole*, we may write,

$$\text{volts generated per conductor} = \frac{\Phi p N}{10^8 \times 60}$$

It is not at present necessary to discuss the different methods of winding armatures, but let there be a total of  $Z$  conductors counted on the face of the armature. Then, if the connections of the individual coils are so made that there are  $p_1$  electrical circuits in parallel in the armature, the generated volts will be

$$E = \frac{\Phi p N Z}{60 \times p_1 \times 10^8} \quad (38)$$

This is the fundamental voltage equation for the dynamo; it gives the average value of the e.m.f. developed in the armature conductors, and since the virtual and average values are the same in the case of continuous currents, the formula gives the actual potential difference as measured by a voltmeter across the terminals when no current is taken out of the armature. Under loaded conditions, the e.m.f. as calculated by formula (38) is the terminal voltage plus the internal  $IR$  pressure drop.

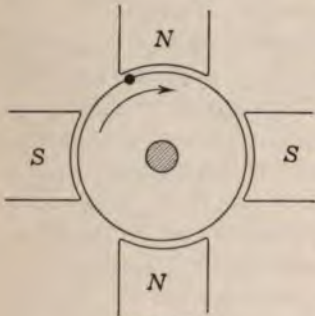

FIG. 23.

The expression "face conductors" may be used to define the conductors the number of which is represented by  $Z$  in the voltage formula. It is evident that this number includes not only the top conductors, but also those that may be buried in the armature slots. The word "inductor" is sometimes used in the place of "face conductor," and where either word is used in the following pages it must be understood to refer to the so-called "active" conductor lying parallel to the axis of rotation whether on a smooth core or slotted armature.

**19. The Output Formula.**—The part of the dynamo to be designed first is the armature. After the preliminary dimensions of the armature have been determined, it is a comparatively

simple matter to design a field system to furnish the necessary magnetic flux. The designer is usually given the following data:

Kw. output,  
Terminal voltage,  
Speed—revolutions per minute.

Sometimes the proper speed has to be determined by the designer, as in getting out a line of stock sizes of some particular type of machine; in that case he will be guided by the practice of manufacturers and the safe limits of peripheral speed. Other conditions such as temperature rise, pressure compounding, sparkless commutation of current, may be imposed by specifications, but if the designer can evolve a formula which will give him an approximate idea of the weight or volume of the armature, this will be of great assistance to him in determining the leading dimensions for a preliminary design. Modifications or corrections can easily be made later, after all the influencing factors have been studied in detail. Many forms of the output formula are used by designers. The formula is based on certain broad assumptions, and is used for obtaining approximate dimensions only. Attempts to develop exact output formulas of universal application should not be encouraged because it is not possible to include all the influencing factors. The art of designing will always demand individual skill and judgment, which cannot be embodied in mathematical formulas.

In developing an output formula it is not necessary to enter into details of the armature winding, provided the total number of conductors, together with the current and e.m.f. in each, are known.

Let  $\Phi$  = maxwells per pole.  
 $p$  = number of poles.  
 $N$  = revolutions per minute.  
 $Z$  = total number of armature inductors.  
 $E_c$  = volts per conductor.  
 $I_c$  = amperes per conductor.

The output of the armature, expressed in watts, will be

$$W = ZE_c I_c \quad (39)$$

where  $I_c$  should include the exciting current in the shunt coils of the field winding; a refinement which need not, however, enter in the preliminary work.

The voltage per conductor is

$$E_c = \frac{\Phi p N}{60 \times 10^8} \quad (40)$$

where the unknown quantity  $\Phi$  may be expressed in terms of flux density and armature dimensions. Thus

$$\Phi p = 6.45 B_p l_a \pi D r \quad (41)$$

where  $B_p$  = average flux density in the air gap under the pole face. (Gausses.)

$l_a$  = gross length of armature core, in inches.

$D$  = diameter of armature core, in inches.

$r$  = the ratio  $\frac{\text{pole arc}}{\text{pole pitch}}$ .

It will be seen that the quantity  $l_a \times \pi D r$  is the area in square inches of the armature surface covered by the pole shoes; while  $6.45 B_p$  is the flux in the air gap per square inch of polar surface.

The pole pitch is usually thought of as the distance from center to center of pole measured on the armature surface; and the ratio  $r$  is therefore a factor by which the total cylindrical surface of the armature must be multiplied to obtain the area covered by the pole shoes—the effect of “fringing” at the pole tips being neglected.

Substituting for  $\Phi p$  in equation (40) its value as given by equation (41), and putting this value of  $E_c$  in equation (39), we have

$$W = \frac{6.45 B_p l_a \pi D r N Z I_c}{60 \times 10^8} \quad (42)$$

from which it is necessary to eliminate  $Z$  and  $I_c$  if the formula is to have any practical value.

A quantity which does not vary very much, whatever the number of poles or diameter of armature, is the *specific loading*, which is defined as the ampere-conductors per inch of armature periphery. It will be represented by the symbol  $q$ . Thus

$$q = \frac{Z I_c}{\pi D}$$

whence

$$Z I_c = q \pi D$$

Substituting in equation (42), we have

$$W = \left( \frac{6.45 \times \pi^2}{60 \times 10^8} \right) B_p q r l_a D^2 N \quad (43)$$

This is not an empirical formula since it is based on fundamental scientific principles, and it is capable of giving valuable information regarding the size of the armature core, provided the quantities  $B_g$ ,  $q$ , and  $r$ , can be correctly determined.

The quantity  $B_g$  will depend somewhat upon whether the pole shoe is of cast iron or steel, also upon the flux density in the armature teeth, which, in turn, depends upon the proportions of the teeth and slots. If the flux density in the teeth is very high, this may lead to (1) an excessive number of ampere-turns on the field poles to overcome tooth reluctance, and (2) excessive power loss in the teeth through hysteresis and eddy currents.

As a guide in selecting a suitable gap density for the preliminary calculations, the accompanying table may be used. The column headed  $B_g$  is the apparent air-gap density in gaussses, while  $B''_g$  is the same quantity expressed approximately in lines per square inch.

APPROXIMATE VALUES OF APPARENT AIR-GAP DENSITY

Output, kw.	$B_g$ (gausses)	$B''_g$ (lines per sq. in.)
10	6,300	41,000
20	7,000	45,000
30	7,300	47,000
40	7,600	49,000
50	7,800	50,000
100	8,100	52,000
200	8,500	55,000
500 and larger	9,000	58,000

The expression "apparent gap density" means that the flux is supposed to be distributed uniformly over the face of the pole and the effect of "fringing" is neglected. Thus

$$B_g = \frac{\text{total flux per pole}}{\text{area of pole face}}$$

It is customary to think of this as the average density over the armature surface covered by the pole face, in which case

$$B_g = \frac{\Phi}{l_a \times \tau \times r}$$

where  $\Phi$ ,  $l_a$ , and  $r$ , have the same meaning as in formula (41), and  $\tau$  is the pole pitch or length of arc from center to center of pole measured on the armature periphery. The lower values of



$B_g$  corresponding to the smaller outputs are required because the increased taper of the teeth with the smaller armature diameters would lead to abnormally high densities at the root of the teeth if the air-gap density were not reduced. The figures given in the table are applicable to machines with pole shoes of steel or wrought iron. If the pole shoes are of cast iron, these values should be reduced about 20 per cent. Cast-iron pole shoes are rarely used except in very small machines.

The quantity  $q$  in formula (43) is determined in the first place by the heating limits; but armature reaction and sparkless commutation have some bearing upon its value. Suitable values of specific loading for use in formula (43) may be taken from the accompanying table.

APPROXIMATE VALUES OF  $q$   
(Ampere Conductors per Inch of Armature Periphery)

Kw. output	$q$
10	320
20	370
30	400
40	430
50	450
100	500
200	550
400	630
600	700
800 and upward	760 to 850

The quantity  $r$  in formula (43) usually has a value between 0.60 and 0.80, a common value being 0.70. When the machine is provided with commutating interpoles the ratio  $\frac{\text{pole arc}}{\text{pole pitch}}$  must be small in order to make room for the interpole. In this case the lower figure of 0.60 would probably be selected as a suitable value for  $r$ .

*Approximate Constants for Use in Output Formula.*—For a first approximation, the output formula (43) may be simplified by substituting average values for the quantities  $B_g$ ,  $q$ , and  $r$ . Thus, if  $B_g = 7,500$ ;  $q = 500$ ; and  $r = 0.7$ , the output formula becomes

$$\text{kw. output} = \frac{l_a D^2 N}{36,000} \quad (44)$$

If the speed of rotation ( $N$ ) is not specified, it is necessary to make some assumptions regarding the *peripheral velocity* of the armature. This velocity lies between 1,200 and 6,000 ft. per minute; the lower values corresponding to machines of which the speed of rotation is low, while the higher values would be applicable to belt-driven dynamos, or to direct-coupled sets of which the prime mover is a high-speed engine or high-head waterwheel. When the generator is coupled to a steam turbine, the speed is always exceptionally high, and the surface velocity of the armature may then attain 2 or 3 miles per minute. The discussion of steam-turbine-driven generators, in so far as the electrical problems differ from those of the lower-speed machines, will be taken up in connection with alternator design.

The peripheral velocity in feet per minute is,

$$v = \frac{\pi DN}{12}$$

whence

$$N = \frac{12v}{\pi D}$$

Inserting this value of  $N$  in formula (44) we get

$$\text{kw. output} = \frac{l_a D v}{9,400} \quad (45)$$

*Relation of  $l_a$  to  $D$ .*—The output equation (43) shows that there is a definite relation between the *volume* of the armature and the output, provided the quantities represented by the symbols  $B_p$ ,  $g$ , and  $r$ , can be estimated. In order to determine the relation between the length  $l_a$  and the diameter  $D$ , certain further assumptions must be made. Thus,

$$l_a = \frac{\pi D r}{p k} \quad (46)$$

where  $p$  = the number of poles, and  $k$  is the ratio  $\frac{\text{pole arc}}{\text{armature length}}$ .

It is desirable to have the pole face as nearly square as possible because this will lead to the most efficient field winding. If the section of the pole core departs considerably from the circular or square section, the length per turn of field winding increases without a proportionate increase of the flux carried by the pole. For a square pole face,  $k = 1$  and

$$\frac{D}{l_a} = \frac{p}{r\pi} = 0.45p \text{ (approximately)}$$

The ratio  $D/l_a$  usually lies between the limits of  $0.35p$  and  $0.65p$ .



It is not always possible or desirable to provide a square pole face, and indeed it is necessary to check the dimensions of the armature core by calculating the peripheral velocity. If a suitable value for the peripheral velocity can be assumed, the diameter is readily calculated because

$$D = \frac{12v}{\pi N}$$

**20. Number of Poles—Pole Pitch—Frequency.**—For calculating the relation between the length and diameter of armature core by formula (46), the number of poles  $p$  must be known. The selection of a suitable number of poles will be influenced by considerations of frequency and pole pitch.

*Frequency of D.C. Machines.*—The frequency of currents in the armature conductors and of flux reversals in the armature core generally lies between 10 and 40 cycles per second in continuous-current generators. Higher frequencies are allowable, but should be avoided, if possible, because—on account of increased losses in the iron, or increased weight to limit these losses—the use of high frequencies is uneconomical. The frequency is  $f = \frac{p}{2} \times \frac{N}{60}$  whence

$$p = \frac{120f}{N} \quad (47)$$

This relation is useful for determining the probable number of poles when the diameter, and therefore the peripheral velocity, are not known.

*Pole Pitch.*—The width of the pole pitch is limited by armature reaction. It will readily be understood that the armature ampere-turns per pole will be proportional to the pole pitch, except for variations in the specific loading ( $q$ ). With a large number of ampere-turns per pole on the armature, it is necessary to provide a correspondingly strong exciting field in order that the armature shall not overpower the field and produce excessive distortion of the air-gap flux, resulting in poor regulation and sparking at the brushes with changes of load. A good practical rule is that the ampere-conductors on the armature shall not exceed 15,000 per pole; *i.e.*, in the space of one pole pitch.

*Ampere-turns on Armature.*—Exactly what is meant by the expression "ampere-turns per pole" when applied to the armature winding should be clearly understood. In a two-pole

machine, the total number of ampere-turns on the armature is  $SI = \frac{Z}{2} \times I_c$  because the current  $I_c$  in  $\frac{Z}{2}$  conductors on one-half of the armature surface is balanced by an equal but opposite

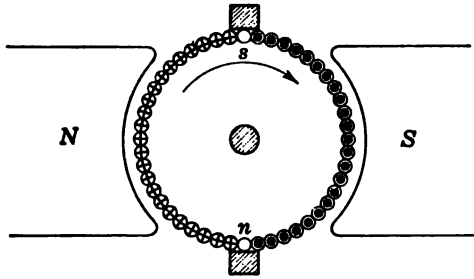

FIG. 24.—Current distribution—bi-polar armature.

current in  $\frac{Z}{2}$  conductors on the other half of the armature surface, as indicated in Fig. 24. Now, since there are two poles, we may say the ampere-turns per pole are

$$(SI)_a = \frac{1}{2} \frac{ZI_c}{2}$$

or just half the number of ampere-conductors in a pole pitch. This rule applies also to the multipolar machines. Thus, in Fig.

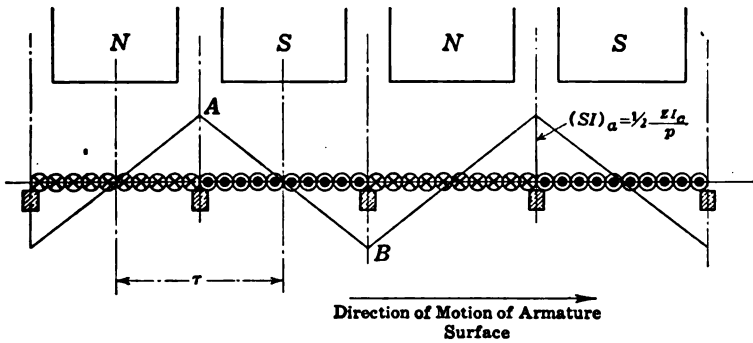

FIG. 25.—Armature m.m.f.—multipolar dynamo.

25, the horizontal datum line may be thought of as the developed surface of a four-pole dynamo armature. The brushes are so placed on the commutator that they short-circuit the coils when these are approximately halfway between the pole tips. It is, therefore, permissible to show the brushes in this diagram as if

they were actually in contact with the conductors on the "geometric neutral" line. The armature m.m.f. will always be a maximum at the point where the brushes are placed, because the direction of the current in the conductors changes at this point, producing between the brushes belts of ampere-conductors of opposite magnetizing effect, as indicated in Fig. 25. The broken straight line indicates the distribution of the armature m.m.f. over the surface. Its maximum positive value occurs at  $A$  and its maximum negative value at  $B$ . These maximum ordinates are of the same height, and equal to one-half the ampere-conductors per pole pitch as will be readily understood by inspecting the diagram. Thus, whether the machine is bipolar or multipolar, the armature ampere-turns per pole are

$$\begin{aligned}(SI)_a &= \frac{1}{2} \text{ ampere-conductors per pole pitch} \\ &= \frac{ZI_c}{2p}\end{aligned}\quad (48)$$

In practice, a safe limit for the pole pitch is  $\tau = \frac{15,000}{q}$ . If  $q = 750$ , the maximum allowable pole pitch is  $\tau = 20$  in., which dimension is rarely exceeded in ordinary types of dynamos.

*Number of Poles.*—The formula (45) gives the output in terms of the peripheral velocity. In its complete form it would be written

$$\text{kw. output} = l_a D v \times B_p q r \times 4 \times 10^{-11} \quad (49)$$

By eliminating  $l_a$  and  $D$  from the equation, it is possible to arrive at an expression for the number of poles in terms of the peripheral velocity and other quantities for which values can be assumed. Thus, by (46)

$$l_a = \frac{r \pi D}{p k}$$

In order to eliminate  $D$ , let  $(SI)_a$  be the armature ampere-turns per pole. Then

$$\tau = \frac{\pi D}{p} = \frac{2(SI)_a}{q}$$

whence

$$D = \frac{2p(SI)_a}{\pi q}$$

By substituting these values for  $l_a$  and  $D$  in equation (49) we get

$$p = \text{kw.} \times \frac{\pi k q \times 10^{11}}{16 r^2 v B_p (SI)_a^2} \quad (50)$$

By assuming values for the quantities in the right-hand side of the equation, a reasonable figure for the number of poles can be obtained. As an example, let the assumed values be as follows,

$$\begin{aligned} k &= 1 \\ q &= 650 \\ r &= 0.7 \\ v &= 4,500 \\ B_g &= 7,500 \\ (SI)_a &= 7,500 \end{aligned}$$

The number of poles will then be

$$p = 0.0138 \text{ kw.}$$

If the machine is to have an output of 500 kw., the estimated number of poles is

$$p = 7$$

and since an even number of poles is necessary, the required figure is 6 or 8. This, of course, would mean a change in one or more of the assumed quantities.

The proper number of poles is determined partly by the amount of the current to be collected from each brush set. This will influence the selection of suitable values for  $k$  and  $(SI)_a$  in formula (50). Values as high as 1,000 amp. per brush arm are used in connection with low-voltage machines; but, on machines wound for 250 to 500 volts, the current collected per brush arm usually lies between the limits of 700 and 300 amp.

As a guide in selecting a suitable number of poles for a preliminary design, the accompanying table may be of use. It is based on the usual practice of manufacturers.

NUMBER OF POLES AND USUAL SPEED LIMITS OF DYNAMOS

Output, kw.	No. of poles	Speed, rev. per min.
0 to 10	2	2,400 to 600
10 to 50	4	1,300 to 350
50 to 100	4 or 6	1,100 to 230
100 to 300	6 or 8	700 to 160
300 to 600	6 to 10	500 to 120
600 to 1,000	8 to 12	400 to 100
1,000 to 3,000	10 to 20	200 to 70

When using this or any other table or data intended to assist the designer with approximate values, it is necessary to exercise judgment, or at least be guided by common sense. For instance it may be necessary to depart from the values given in the table in the case of machines direct-coupled to slow-running engines. This is especially worth noting in the case of the smaller machines, which may require more than four poles in order to give the best results on very low speeds.



## CHAPTER V

### ARMATURE WINDINGS AND SLOT INSULATION

**21. Introductory.**—The object of this chapter is to explain the essential points which the designer must keep in mind when determining the number of slots, the space taken up by insulation, the cross-section of the copper windings, and the method of connecting the individual conductors so as to produce a finished armature suitable for the duty it has to perform. It is assumed that the reader is familiar with the appearance of a D.C. machine and understands generally the function of the commutator. For this reason it is proposed to omit such elementary descriptive matter as may be found in every textbook treating of electrical machinery. On the other hand, the practical details of manufacture and much of the nomenclature used in the design room and shops of manufacturers will also be omitted, because space does not permit of the subject being treated exhaustively; but if the reader will exercise his judgment and rely upon his common sense, he will be able to design a practical armature winding to fulfil any specified conditions.

The direction of the generated e.m.f. will depend upon the direction of the flux through which the individual conductor is moving, and it is therefore a simple matter so to connect the armature coils that the e.m.fs. shall be additive. It does not matter whether the machine is bipolar or multipolar, ring- or drum-wound, it is always possible to count the number of conductors in series between any pair of brushes and thus make sure that the desired voltage will be obtained.

Closed-coil windings will alone be considered, because the open-circuit windings—as used in the early THOMSON-HOUSTON machines and other generators for series arc lighting systems—are now practically obsolete. Another type of machine, known as the *homopolar* or *acyclic* D.C. generator, although actually used and built at the present time, has a limited application and will not be considered here. The absence of the commutator is the feature which distinguishes this machine from the

more common types; but it is not suitable for high voltages, and the friction and  $I^2R$  losses in the brushes are very large.<sup>1</sup>

**22. Ring- and Drum-wound Armatures.**—The GRAMME ring winding is now practically obsolete. In this type of machine the coils form a continuous winding around the armature core which is in the form of a ring with a sufficient opening to allow of the wires passing down the inside of the core parallel to the axis of rotation. The objections to this winding are the high resistance and reactance of the armature coils due to the large proportion of the "inactive" material per turn. This has a bearing not only on the cost and efficiency of the machine but also on commutation, because the high inductance of the windings is liable to cause sparking at the brushes.

In the drum winding all the conductors are on the outside surface of the armature, and although space is usually provided, even in small machines, between the inside of the core and the shaft, this space is used for ventilating purposes only and is not occupied by the armature coils. The drum winding is simply the result of so arranging the end connections that the e.m.f.s. generated in the various face conductors shall assist each other in providing the total e.m.f. between brushes. Both windings, whether of the ring or drum type, are continuous and closed upon themselves, and if the brushes are lifted off the commutator there will be no circulating currents because the system of conductors as a whole is cutting exactly the same amount of positive as of negative flux.

**23. Multiple and Series Windings.**—Nearly all modern continuous-current generators are provided with former-wound coils. These coils are made up of the required number of turns, and pressed into the proper shape before being assembled in the slots of the armature core. Smooth-core armatures are very rarely used, and the slotted armature alone will be considered. In all but two-pole machines (which are rarely made except for small outputs or exceptionally high speeds) there is practically only one type of coil in general use. This is generally of the

<sup>1</sup> For information on the homopolar type of machine see "Acyelic (Homopolar) Dynamos," by J. E. NOEGGERATH, *Trans. A. I. E. E.*, vol. XXIV (1905), pp. 1 to 18, and the article by the same writer, "Acyelic Generators," in the *Electrical World*, Sept. 12, 1908, p. 575. Also "Homopolar Generators," by E. W. MOSS and J. MOULD, *Journal Inst. E. E.*, vol. 49 (1912), pp. 804 to 816.



shape shown in Fig. 26. The finished coil may consist of any number of turns, but as there are two coil-sides in each slot, there will be an even number of inductors per slot. The portion of the armature periphery spanned by each coil is approximately equal to the pole pitch  $\tau$ , because it is necessary that one coil side shall be cutting positive flux while the other coil side is cutting negative flux. If the two coil sides lie in slots exactly

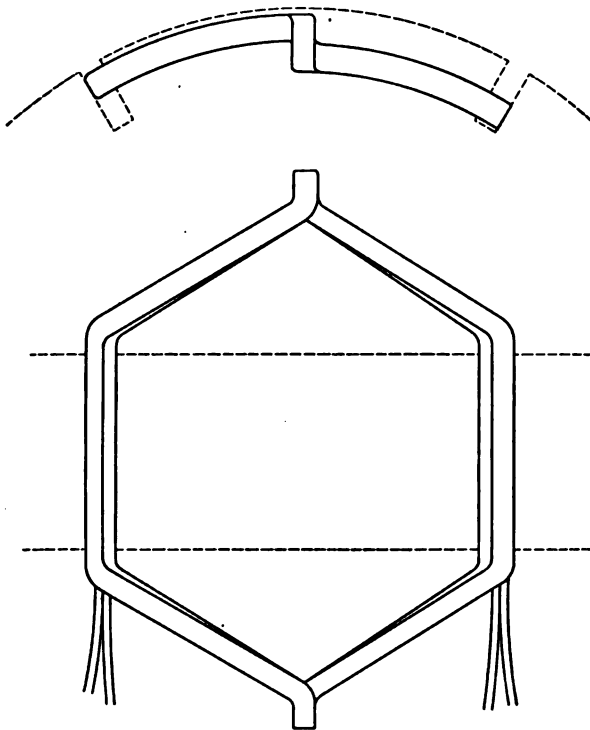

FIG. 26.—Form-wound armature coil.

one pole pitch apart, the winding is said to be *full pitch*. If the width of coil is less than  $\tau$ , the winding is said to be *short pitch* or *chorded*. The shortening of the pitch slightly reduces the length of inactive copper in the end connections. Some designers claim that it gives better commutation; but, on the other hand, it reduces the effective width of the zone of commutation, and it is doubtful if either winding has a distinct advantage over the other.

There are two entirely different methods of joining together

the individual coils. Thus, if the two ends of the coil shown in Fig. 26 are connected to neighboring commutator bars, as in Fig. 27a, we obtain a *multiple* or *lap* winding, while, if the ends are taken to commutator bars approximately a pole pitch apart, (Fig. 27b), we obtain the *series* or *wave* winding. The important distinction between these two styles of winding is the fact that, with the multiple winding, there are as many sets of brushes and

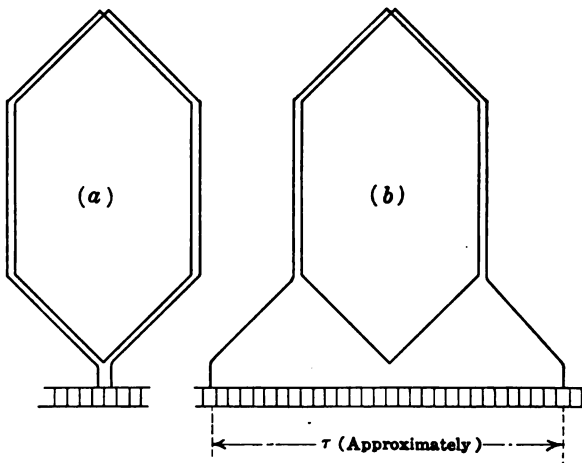

FIG. 27.—Multiple and series armature coil connections.

as many parallel paths through the armature as there are poles while, with the series winding, there are only two electrical paths in parallel through the armature, and only two sets of brushes are necessary, although a greater number of brush sets may be used.<sup>1</sup>

<sup>1</sup> What are known as simplex windings are here referred to. Multiplex windings may be used on lap-wound machines when the current is large and it is desired to have two or more separate circuits connected in parallel by sufficiently wide brushes. This tends to improve commutation. In series-wound machines the multiple winding has the advantage that it enables the designer to obtain more than two circuits in parallel, but not as many as there are poles. In this manner it is possible to provide for a number of parallel paths somewhere between the limits set by the simplex wave and lap windings respectively. These windings are, however, rarely met with. Again, a duplex winding may be singly re-entrant or doubly re-entrant. In the former case, the winding would close on itself only after passing twice around the armature, while, in the latter case, there would be two independent windings. It is suggested that the reader need not concern himself with these distinctions, which have no bearing on the principles of armature design. More complete information can be found in many textbooks and in the handbooks for electrical engineers.

The two kinds of winding are shown diagrammatically in Figs. 28 and 29. The former shows a simplex lap-wound multipolar drum armature, while the latter represents in a similar diagrammatic manner a simplex wave-wound multipolar drum armature. In practice there would ordinarily be a greater number of coils and commutator bars, and the conductors would be in slots. This is indicated by the grouping of the conductors

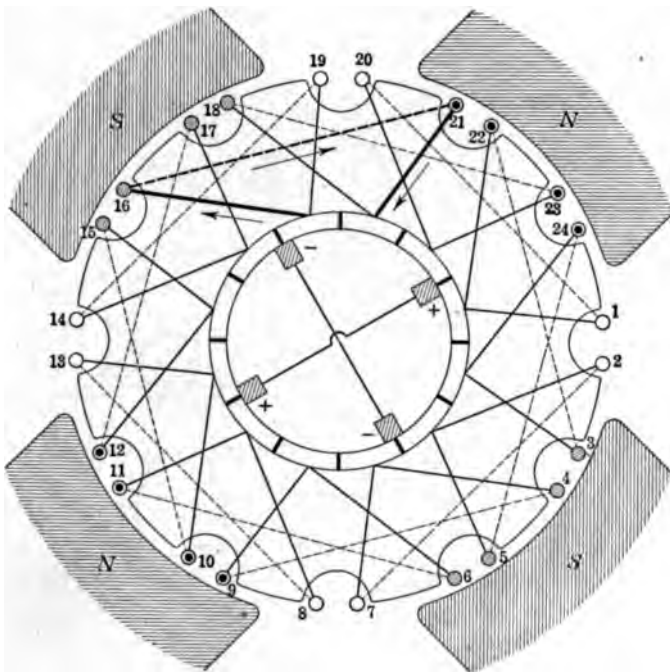

FIG. 28.—Diagram of simplex multiple winding.

in pairs, the even-numbered inductors being (say) in the bottom of the slot, with the odd-numbered inductors immediately above them in the top of the slot.

It should particularly be noted that the lap or multiple winding provides as many electrical circuits in parallel as there are poles, and the number of brush sets required is the same as the number of poles. Thus if  $I$  is the current in the external circuit, plus the small component required for the shunt field excitation, the current in the armature windings is  $I/p$  and the current collected by each set of brushes is  $\frac{2I}{p}$ .

In the case of the wave, or series, winding there will be two paths in parallel through the armature, whatever may be the number of poles. Two sets of brushes will, therefore, suffice to collect the current; but more sets may be used if desired, in order to reduce the necessary length of the commutator. In this case the brushes would be placed one pole pitch apart around the commutator, and all brush sets of the same polarity would be joined in parallel. This does not, however, increase

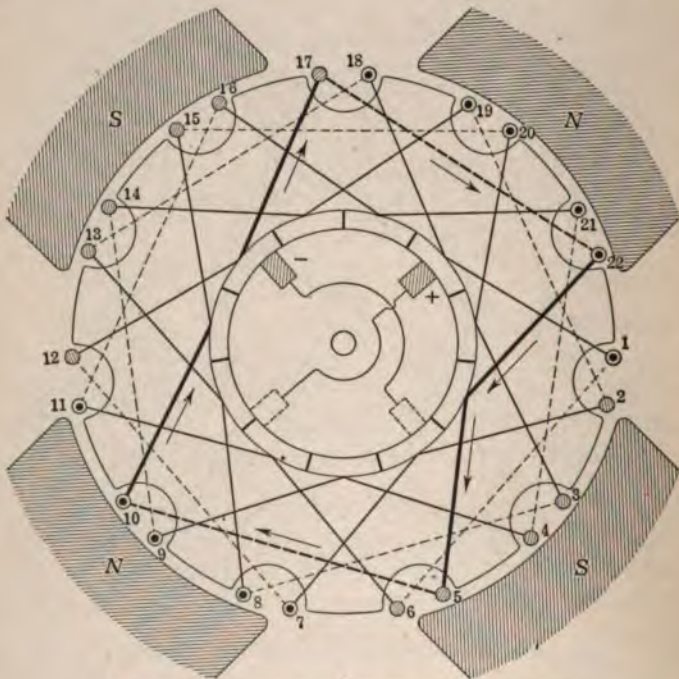

FIG. 29.—Diagram of simplex series winding.

the number of electrical paths in parallel in the armature, but merely facilitates the collection of the total current, as will be understood by carefully studying the winding diagrams. The series winding is usually adopted when the voltage is high and the current correspondingly reduced; it is, therefore, rarely necessary to provide more than two sets of brushes. When a greater number of brush sets is provided on a series-wound machine, it is not easy to ensure that the current will be equally divided between the various sets of brushes. What is known as *selective*

commutation then occurs, each brush set collecting current in proportion to the conductance of the brush contact. This leads to sparking troubles unless ample brush surface is provided.

The fact that there may be only two sets of brushes on a multipolar dynamo does not necessarily indicate a wave-wound armature. The commutators of lap-wound machines are sometimes provided with an internal system of cross-connections whereby all commutator bars of the same potential are joined

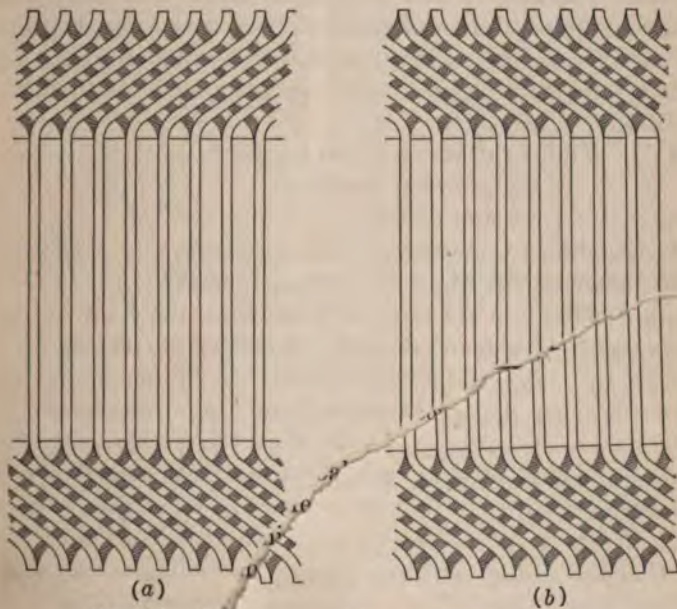

FIG. 30.—Appearance of lap and wave windings.

together. This allows of only two sets of brushes being used; but the length of the commutator must, of course, be increased to provide the brush-contact surface necessary for the proper collection of the current. The external appearance of the parallel and series windings respectively is indicated by sketches (a) and (b) of Fig. 30. The observer is supposed to be looking down on the cylindrical surface of the finished armature.

If there are two coil sides in each slot, the number of commutator bars will be the same as the number of armature slots, whether the coils are connected to form a multiple or a series winding. It is, however, by no means necessary to limit the



number of commutator bars to the number of slots, as the total number of inductors in each slot may be subdivided, and a correspondingly greater number of commutator bars can be used. This point will be again referred to when treating of the slot insulation.

With a series-wound armature, the number of commutator bars cannot be a multiple of the number of poles, because this would lead to a closed winding after stepping once around the armature periphery. The winding must advance or retrogress by one commutator bar when it has been once around the armature, and this leads to the rule that a series-wound machine must have a number of commutator segments such as to fulfil the condition:

$$\left. \begin{array}{l} \text{Number of commutator segments} \\ \text{in wave-wound machine} \end{array} \right\} = \frac{p}{2} \pm 1$$

where  $k$  is any whole number.<sup>1</sup>

#### 24. Equalizing Connections for Multiple-wound Armatures.—

If the magnetic circuits of the various parallel paths in the lap-wound dynamo are not of equal reluctance, there will be an unbalancing of the generated e.m.fs. producing circulating currents through the brushes. The inequality of the magnetic permeances is usually due to eccentricity of the armature relatively to the bore of the poles, and even when the unbalancing effect is small in a new machine, it is liable to increase owing to wear of the bearings.

Fig. 31 is a developed view of a four-pole winding. Suppose that the section  $A$  of the armature winding is nearer to the pole face than the section  $C$ . The voltage generated in the conductors occupying the latter position will be less than in the

<sup>1</sup> Although an armature may be provided with an odd number of slots, it does not follow that it will accommodate a wave winding suitable for all voltages, without modification. Thus, if a six-pole machine has 73 armature slots, it may be necessary to have two coils (or four coil-sides) per slot in order to obtain the necessary voltage and avoid too great a difference of potential between adjacent commutator bars. This means that the number of coils and of commutator segments would be 146, which would not be suitable for a wave winding. By having one dummy or "dead" coil, the total number of coils (and commutator segments) will be 145, which being equal to  $(48 \times \frac{3}{2}) + 1$  will give a wave winding. The "dead" coil is put in for appearance and to balance the armature, but it is not connected up. The use of dead coils should be avoided as it adds to the difficulties of commutation.

conductors moving through the region *A*. The result will be a tendency for a current to circulate in the path *AECF* as indicated by the dotted arrows. The net result will be a strengthening of the current leaving the machine at one set of brushes and a corresponding weakening of the current at the other set of brushes. This unbalancing of the current may lead to serious sparking troubles. To prevent the inequality of voltage in the different sections of the windings it is necessary to go to the root of the trouble and correct the differences in the reluctance of the various magnetic paths. This cannot, however, always be accomplished perfectly or in a lasting manner; but, by providing

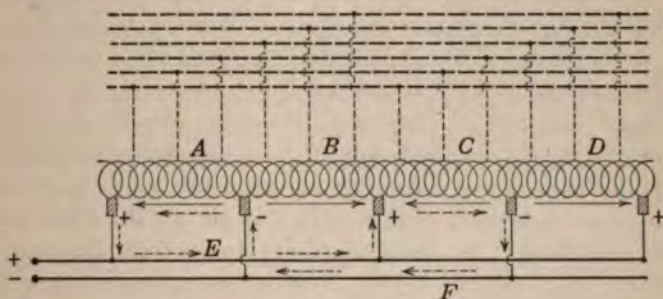

FIG. 31.—Equalizer connections.

easy paths for the out-of-balance current components, it is possible to equalize the differences of pressure before the current reaches the brushes. This is done by connecting together points on the armature winding which should be at the same potential. In practice a number of insulated copper rings are provided and connected to equipotential points on the commutator. The dotted lines in Fig. 31 show six equalizing rings. Actually, from six to eight points per pair of poles would probably be cross-connected.

It should be clearly understood that the equalizing connections of lap-wound armatures do not prevent the unbalancing of currents; but, by providing a short-circuit to the paths through brushes and connecting leads of the same sign, they tend to maintain the equality of currents through the various brush sets. In the simplex wave winding, with only two armature paths in parallel, equalizing connections are not necessary.

**25. Insulation of Armature Windings.**—No great amount of insulation is necessary on each wire or conductor of an armature



winding because, even in machines of large output, the voltage generated per turn of wire is comparatively small. The difference of potential between the winding as a whole and the armature core may, however, be very great on high-voltage machines, and the slot lining must be designed to withstand this pressure with a reasonable factor of safety. About the same amount of insulation as will be necessary for the slot linings will also have to be provided between the upper and lower coil-sides in each slot, because the potential difference between the two sets of conductors in the slot is the same as that between the terminals of the machine. The space occupied by insulation relatively to the total space available for the winding will depend not only upon the voltage of the dynamo, but also upon such factors as the number of slots and their cross-section and proportions. Even if the total slot area remains constant, the larger number of slots will naturally require the greater amount of insulation, and thus reduce the space available for copper. Again, a wide slot, by reducing the tooth width, may be the cause of unduly high densities in the teeth, while a deep slot is undesirable on account of increased inductance of the windings, and because it may lead to an appreciably reduced iron section at the root of the tooth in armatures of small diameter.

With the ordinary double-layer winding, the square coil section would give the best winding space factor. Thus if each of the two coil-sides were made of square cross-section, the total depth of slot including space for binding wires or wedge would be from two and one-fourth times to two and one-half times the width. In practice the slot depth is frequently three times the width, but this ratio should not exceed  $3\frac{1}{2}$  because the design would be uneconomical, and the high inductance of the winding might lead to commutation difficulties.

Although the calculation of flux densities in the teeth will be dealt with later, it may be stated that it is usual to design the slot with parallel sides and make the slot width from 0.4 to 0.6 times the slot pitch. It is very common to make slot and tooth width the same (*i.e.*, one-half the pitch) on the armature surface, especially in small machines. In large machines the ratio  $\frac{\text{tooth width}}{\text{slot width}}$  is frequently about 1.1.

What has been referred to as the slot pitch may be defined as

the ratio, armature surface periphery divided by the total number of slots.

**26. Number of Teeth on Armature.**—It is obvious that a small number of teeth would lead to a reduction of space taken up by insulation and, generally speaking, would lead also to a saving in the cost of manufacture. Other considerations, however, show that there are many points in favor of a large number of teeth. Unless the air gap is large relatively to the slot pitch, there will be appreciable eddy-current loss in the pole pieces on account of the tufting of the flux lines at the tooth top. Again, pulsations of flux in the magnetic circuit are more liable to be of appreciable magnitude with few than with many teeth, and when the tooth pitch is wide in relation to the space between pole tips, commutation becomes difficult because of the variation of air-gap reluctance in the zone of the commutating field. A good practical rule is that the number of slots per pole shall not be less than 10, and that there shall be at least three and one-half slots in the space between pole tips. In high-speed machines with large pole pitch, from 14 to 18 slots per pole would usually be provided. With the exception of small generators (machines with armatures of small diameter), the cross-section of the slot is about constant, and approximately equal to 1 sq. in. This corresponds to about 1,000 amp. conductors per slot for machines up to 600 volts, on the basis of the current densities to be discussed later.

**27. Number of Commutator Segments—Potential Difference between Segments.**—Machines may be built with a number of commutator bars equal to the number of slots in the armature core. In this case there will be one coil per slot, *i.e.*, two coil-sides in each slot. There is, however, no reason why the number of coils<sup>1</sup> should not be greater than the number of slots. The usual number of commutator segments per slot is two or three in low-voltage machines, with a maximum of four or five in low-speed dynamos for high voltages. The number of commutator bars may therefore be a multiple of the number of slots. A

<sup>1</sup> The word *coil* as here used denotes the number of turns included between the tappings taken to commutator bars. In practice one-half the number of conductors in a slot might be taped up together and handled as a single coil, but if tappings are taken from the ends so as to divide the complete coil in two or more sections electrically, we may speak of four, six, or more coil-sides in a single slot, notwithstanding the fact that these may be bunched together and treated as a unit when placing the finished coils in position.



large number of bars improves commutation, but increases the cost of the machine; a large diameter of commutator is necessary in order that the individual sector shall not be too thin. The copper bars are insulated from each other by mica, usually about  $\frac{1}{32}$  in. thick, increasing to  $\frac{1}{20}$  in. for machines of 1,000 volts and upward. It follows that a commutator with a very large number of segments is less easily assembled and less satisfactory from the mechanical standpoint than one with fewer segments.

The best way to determine the proper number of commutator bars for a particular design of dynamo is to consider the voltage between neighboring bars. This voltage is variable, and depends upon the distribution of the magnetic flux over the armature surface, and upon the position of the armature coil under consideration. The maximum potential difference between adjacent commutator bars rarely exceeds 40 volts, and the average voltage should be considerably lower than this. The average voltage between bars may be defined as the potential difference between + and - brush sets divided by the number of commutator segments counted between the brushes of opposite sign. As a rough guide, it may be stated that the value of 15 volts (average) between segments should not be exceeded in machines without interpoles. About double this value is permissible as an upper limit on machines with commutating interpoles, especially if they are provided with compensating pole-face windings which prevent the distortion of flux distribution under load. In practice the allowable average voltage between commutator bars is based upon the machine voltage and, to some extent, upon the kilowatt output, although few designers appear to pay much attention to the influence of the current in determining the number of commutator segments. As an aid to design, the following values may be used for the purpose of deciding upon a suitable number of coils and commutator bars.

Machine voltage	Volts between commutator segments
110	1 to 6
220	2.5 to 10
600	5 to 18
1,200	9 to 25

**28. Nature and Thickness of Slot Insulation.**—Since the average voltage between the terminals of an armature coil does not exceed 25 volts, it follows that the potential difference be-

tween the conductors in one coil cannot be very high. The copper conductors are usually insulated with cotton spun upon the wire in two layers. Cotton braiding is sometimes used on large conductors of rectangular section; and a silk covering is used on very small wires where a saving of space may be effected and an economical design obtained notwithstanding the high price of the silk covering. A triple cotton covering is occasionally used when the potential difference between turns exceeds 20 volts. Conductors of large cross-section may be insulated by a covering of cotton tape put on when the coil is being wound.

In addition to the comparatively small amount of insulation on the wires, a substantial thickness of insulation must be provided between the armature core and the winding as a whole. The materials used for slot lining are:

1. Vulcanized Fiber; Leatheroid or Fish Paper; Manilla Paper; Pressboard; Presspahn; Horn Fiber; etc.; all of which, being tough and strong, are used mainly as a mechanical protection because they are more or less hygroscopic and cannot be relied upon as high-pressure insulators, especially when moisture is present.

2. Mica; Micanite; Mica Paper or Cloth. These materials are good insulators, and the pure mica or the micanite sheet will withstand high temperatures. Sheet micanite is built up of small pieces of mica split thin and cemented together by varnish. The finished sheet is subjected to great pressure at high temperatures in order to expel the superfluous varnish. Mica is hard and affords good protection against mechanical injury; but it is not suitable for insulating corners or surfaces of irregular shape.

3. Treated Fabrics, such as Varnished Cambric; Empire Cloth, etc. These provide a means of applying a good insulating protection to coils of irregular shape. Linseed oil is very commonly used in the preparation of these insulating cloths and tapes because it has good insulating properties and remains flexible for a very long time.

It is common practice to impregnate the finished armature coil with an insulating compound, and press it into shape at a fairly high temperature. When this is done, ordinary untreated cotton tape is used in place of the varnished insulation.

Fig. 32 shows a typical slot lining for a 500-volt winding. This can, however, be modified in many respects, and the reader

need not at present concern himself with practical details of manufacture. It is obvious that the insulation should be so arranged as to leave the greatest possible amount of space for the copper.



FIG. 32.—Insulation of conductors in slot.

The insulation may be placed around the individual coils, or in the slot before the coils are inserted. If preferred, part of the insulation may be put around the coils and the remainder in the form of a slot lining. The essential thing is to have sufficient thickness of insulation between the cotton-covered wires and the sides of the slot. The following figures may be used in determining the necessary thickness of slot lining.

These figures give the thickness, in inches, of *one side* only, and this is also the thickness that should be provided between the upper and lower coil sides in the slot.

For machines up to 250 volts.....	0.035 in.
For machines up to 500 volts.....	0.045 in.
For machines up to 1,000 volts.....	0.06 in.
For machines up to 1,500 volts.....	0.075 in.

In high-voltage machines an air space is sometimes allowed between the end connections, *i.e.*, the portions of the coils not included in the slots. This air clearance would be from  $\frac{3}{8}$  to  $\frac{1}{2}$  in. for a difference of potential of 1,000 volts, with an addition of  $\frac{1}{8}$  in. for every 500 volts. In regard to the surface leakage where the coils pass out from the slots; a breakdown of insulation at this point is usually guarded against by allowing the slot lining to project at least  $\frac{1}{2}$  in. beyond the end of the slot. For working pressures above 500 volts, add  $\frac{1}{4}$  in. for every additional 500 volts.

The finished armature should withstand certain test pressures to ensure that the insulation is adequate. The standardization rules of the A.I.E.E. call for a test pressure of twice the normal voltage plus 1,000 volts.

**29. Current Density in Armature Conductors.**—The permissible current density in the armature coils is limited by tem-



perature rise. The hottest accessible part of the armature, after a full-load run of sufficient duration to attain very nearly the maximum temperature, should not be more than 40° or 45°C. above the room temperature. No definite rules can be laid down in the matter of armature conductor section because the ventilation will be better in some designs than in others, and a large amount of the heat to be dissipated from the armature core is caused by the iron loss which, in turn, depends upon the flux density in teeth and core.

The current density in the armature windings generally lies between the limits of 1,500 and 3,000 amp. per square inch. If the armature were at rest, the permissible current density would be approximately inversely proportional to the specific loading,  $q$ , *i.e.*, to the ampere-conductors per inch of armature periphery. When the armature is rotating, the additional cooling effect due to the movement through the air will be some function of the peripheral velocity, and, for speeds up to about a mile a minute—or, say, 6,000 ft. per minute—the permissible increase of current density will be approximately proportional to the increase in speed. The constants for use in an empirical formula expressing these relations are determined from tests on actual machines, and the writer proposes the following formula for use in deciding upon a suitable current density in the armature winding:

$$\Delta = \frac{500,000}{q} + \frac{v}{3} \quad (51)$$

where  $\Delta$  stands for amperes per square inch of copper cross-section, and  $v$  is the peripheral velocity in feet per minute.

**30. Length and Resistance of Armature Winding.**—Before the resistance drop and the  $I^2R$  losses in the armature can be calculated, it is necessary to estimate the length of wire in a coil. This length may be considered as made up of two parts: (1) the “active” part, being the straight portion in the slots, and (2) the end connections.

The appearance of the end connection is generally as shown in Fig. 33, and since the pitch of the coil is measured on the circumference of the armature core, the sketch actually represents the coils laid out flat, before springing into the slots.

The angle  $\alpha$  which the straight portion of the end connections makes with the edge of the armature core is  $\sin^{-1} \frac{s + \delta}{\lambda}$  where  $\lambda$  is the slot pitch;  $s$ , the slot width; and  $\delta$ , any necessary clear-



ance between the coils. This clearance need be provided only in high-pressure machines, or when it is desired to improve ventilation. For approximate calculations on machines up to 600 volts, the angle  $\alpha$  may be calculated from the relation  $\sin \alpha = \frac{1.15 s}{\lambda}$ .

In practice the angle  $\alpha$  usually lies between 35 and 40 degrees. The length of the straight part  $AC$  (Fig. 33) is  $\frac{BA}{\cos \alpha}$  where  $BA$  is half the coil pitch, or  $\frac{\tau}{2}$  in the case of a full-pitch winding.

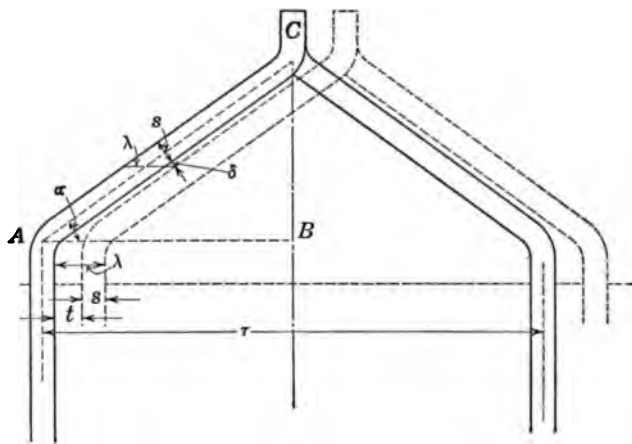

FIG. 33.—End connections of armature coil.

The portion of the end connections between the end of the slot and the beginning of the straight portion  $AC$  is about  $\frac{3}{4}$  in. in low-voltage machines, increasing to 1 in. in machines for pressures between 500 and 1,000 volts. The allowance for the loop where the coil is bent over to provide for the lower half of the coil clearing the upper layer of conductors will depend upon the depth of the coil-side and therefore upon the depth of the slot. If  $d$  is the total slot depth, in inches, an allowance equal to  $2d$  will be sufficient for this loop. The total length of coil outside the slots of a low-voltage armature will therefore be

$$l_e = \left( \frac{2\tau}{\cos \alpha} + 4d + 3 \right) \text{ in.} \tag{52}$$

where  $\tau$  must be taken to represent the coil pitch instead of the pole pitch if the winding is of the chorded or short-pitch type.

The average length per turn of one coil will be  $2l_a + l_c$  where  $l_a$  is the gross length of the armature core. A small addition should be made for the connections to the commutator, especially if the coil has few turns.<sup>1</sup> The resistance of each coil, and therefore of each electrical path through the armature, may now be readily calculated. In arriving at the resistance of the armature as a whole it is important to note carefully the number of coils in series in each armature path, and the number of paths in parallel between the terminals of the machine. As a check on the calculated figures, the  $IR$  drop, or the  $I^2R$  loss, in the armatures of commercial machines, expressed as a percentage of the terminal voltage or of the rated output, as the case may be, is usually as stated below:

In 10-kw. dynamo.....	3.1 to 3.8 per cent.
In 30-kw. dynamo.....	2.6 to 3.2 per cent.
In 50-kw. dynamo.....	2.4 to 3.0 per cent.
In 100-kw. dynamo.....	2.1 to 2.6 per cent.
In 200-kw. dynamo.....	2.0 to 2.4 per cent.
In 500-kw. dynamo.....	1.9 to 2.1 per cent.

<sup>1</sup> There is another type of end connection, known as the involute end winding. It is not much used; but those interested in the matter are referred to the first volume of "The Dynamo" by HAWKINS and WALLIS (WHITTAKER & Co.), where the manner of calculating the length of these end connections is explained.

## CHAPTER VI

### LOSSES IN ARMATURES—VENTILATION— TEMPERATURE RISE

**31. Hysteresis and Eddy-current Losses in Armature Stampings.**—The loss due to hysteresis in iron subjected to periodical reversals of flux may be expressed by the formula,

$$\text{watts per pound} = K_h B^{1.6} f$$

where  $K_h$  is the hysteresis constant which depends upon the magnetic qualities of the iron. The symbols  $B$  and  $f$  stand as before for the flux density and the frequency.

An approximate expression for the loss due to eddy currents in laminated iron is,

$$\text{watts per pound} = K_e (Bft)^2$$

where  $t$  is the thickness of the laminations, and  $K_e$  is a constant which is proportional to the electrical conductivity of the iron.

With the aid of such formulas, the hysteresis and eddy-current losses can be calculated separately and then added together to give the total watts lost per pound. This method will give good results in the case of transformers; but when the reversals of flux are due to a rotating magnetic field, as in dynamo-electric machinery, the losses do not follow the same laws as when the flux is simply alternating; and moreover there are many causes leading to losses in built-up armature cores which cannot easily be calculated. These additional losses include eddy currents due to burrs on the edges of stampings causing metallic contact between adjacent plates. There are also eddy currents produced in the armature stampings due to the fact that the flux cannot everywhere be confined to a direction parallel to the plane of the laminations. Some flux enters the armature at the two ends and also into the sides of the teeth through the spaces provided for ventilation. Since this flux enters the iron in a direction normal to the plane of the laminations it is sometimes accountable for quite appreciable losses. For these reasons calculations

of core losses should be based on the results of tests conducted with built-up armatures rotated in fields of known strength. Such tests are made at different frequencies, and the results, plotted in graphical form, give the total watts lost per pound of iron stampings at different flux densities, a separate curve being drawn for each frequency. The reader is referred to the handbooks of electrical engineers for useful data of this sort; but for approximate calculations of core losses, the total iron loss *per cycle* may be considered constant at all frequencies. This assumption allows of a single curve being plotted to show the connection between *watts lost per pound* and the product *kilo-gausses*  $\times$  *cycles per second*. This has been done in Fig. 34 which is based on experiments conducted by MESSRS. PARSHALL and HOBART and confirmed lately by PROFESSORS ESTERLINE and MOORE at Purdue University. The curve gives average losses in commercial armature iron stampings 0.014 in. thick. Great improvements in the magnetic qualities of dynamo and transformer iron have been brought about during the last 20 years, and the introduction of 3 to 4 per cent. of silicon in the manufacture of the material known as silicon steel has given us a material in which not only the hysteresis, but also the eddy-current losses, have been very considerably lowered. There are great variations of quality in armature stampings, and values obtained from Fig. 34 would not be sufficiently reliable for the use of the commercial designer of any but small machines. By taking pains in assembling in stampings to avoid burrs and short-circuits between adjoining plates, the total iron loss may be considerably reduced. In large machines, with a surface which is small in proportion to the volume, the losses will usually be less than would be indicated by Fig. 34. In the absence of reliable tests on machines built with a particular quality of iron punchings, it is suggested that the values obtained from Fig. 34 may be reduced as much as 50 per cent. in cases where extra care and expense with a view to reducing losses are justified; and for silicon steel (a more costly material than the ordinary iron plates) the reduction may be as much as 70 per cent.

When calculating the watts lost in the armature core, it is necessary to consider the teeth independently of the section below the teeth. This is because the flux density in the teeth is not the same as that in the body of the armature.



The calculation of the watts lost in the core below the teeth is a simple matter provided the assumption can be made that the flux density has the same value at all points. Although incorrect, this assumption is very commonly made; and, for the purpose of estimating the rise in temperature, the flux density may be calculated by dividing half the total flux per pole by the net cross-section of the armature core below the teeth. A reference to Fig. 34 will give the watts per pound, and this,

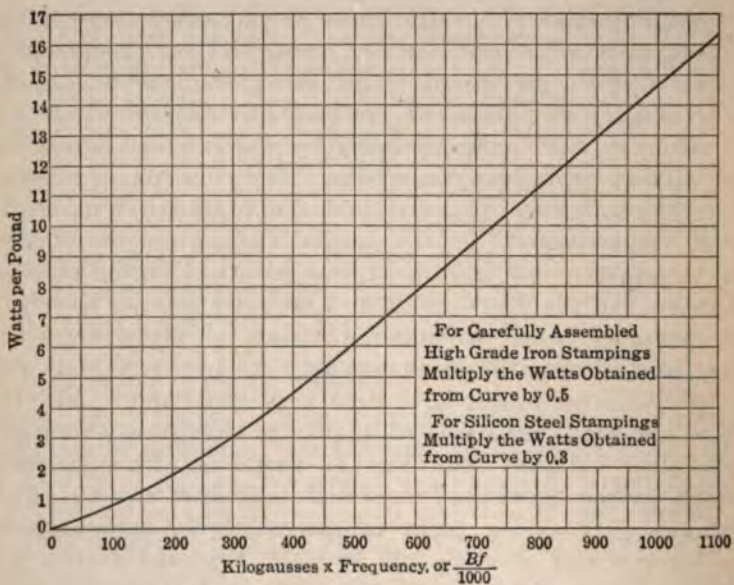

FIG. 34.—Losses in armature stampings.

when multiplied by the total weight of iron in the core (excluding the weight of the teeth), will be the approximate total loss due to hysteresis and eddy currents.

In order to calculate the losses in the armature teeth, it is necessary to know exactly what is the flux density at all sections of the tooth. This is not readily calculated, because some of the flux from the pole pieces enters the armature through the sides of the teeth and the bottom of the slots. Again, in the case of armatures of small diameter having teeth of which the taper may be considerable, the change of section alters the flux density and the degree of saturation, so that it is almost impossible to determine accurately the average value of the tooth

density for use in calculating the watts lost. The question of flux density in the teeth will be again referred to when discussing the m.m.f. necessary to provide the required flux; and formulas will be developed for use in calculating the actual flux density in the iron of the teeth. For the purpose of estimating the temperature rise, we shall assume that the whole of the flux from each pole enters the armature through the teeth under the pole (the effect of fringing at pole tips being neglected); and if the teeth are not of uniform section throughout their length, the average section will be used for calculating the flux density. Thus, let

$$\begin{aligned} \Phi &= \text{the total flux per pole,} \\ \tau &= \text{pole pitch,} \\ \lambda &= \text{tooth pitch,} \\ t &= \text{width of tooth at center,} \\ l_n &= \text{net length of iron in armature,} \\ r &= \text{ratio } \frac{\text{pole arc}}{\text{pole pitch}}. \end{aligned}$$

then the number of teeth under each pole is  $r \frac{\tau}{\lambda}$  and the flux per tooth is  $\frac{\Phi \lambda}{r \tau}$ . The flux density in the tooth, on the assumptions previously made, would, therefore, be  $\frac{\Phi \lambda}{r \tau l_n}$  gausses if the dimensions are expressed in centimeters. By referring to the curve Fig. 34, the watts lost in the teeth per pound of iron can be found. The length  $l_n$  is simply the gross length of the armature core less the space taken up by ventilating ducts and insulation between armature stampings. The question of vent ducts will be taken up immediately; but, even when a suitable allowance has been made for the spaces between the assembled sections of the armature core, a further correction must be made to allow for the thin paper or other insulation between the stampings. The space taken up by this insulation will vary between 7 and 10 per cent. of the total space. Thus, if  $l_a$  is the gross length of the armature, and  $l_v$  the total width of all vent ducts, the net length of the armature core would be.

$$l_n = 0.92 (l_a - l_v)$$

if the space occupied by the insulation between laminations is 8 per cent.



**32. Usual Densities and Losses in Armature Cores.**—The flux density in the core below the teeth will be determined by considerations of heating and efficiency. The same may be said of the tooth density, but in this case the total weight of iron is relatively small, and higher densities are permissible. It is desirable to have a high flux density in the teeth because this leads to a "stiffer" field and reduces the distortion of air-gap flux distribution caused by the armature current. Better pressure regulation is thus obtained, and also improved commutation, especially on machines without interpoles where the fringe of flux from the leading pole tip is used for reversing the e.m.f. in the short-circuited coils under the brush. If the density in the teeth is forced to very high values, the losses will be excessive, especially if the frequency is also high; another disadvantage being the large magnetizing force necessary to overcome the reluctance of the teeth and slots.

The accompanying table gives flux densities in teeth and core that are rarely exceeded in ordinary designs of continuous-current machines.

UPPER LIMITS OF FLUX DENSITY IN DYNAMO ARMATURES (GAUSSSES)

Frequency, $f$	Density in teeth	Density in core
10	23,000	15,000
20	22,000	14,000
30	21,000	13,000
40	20,000	12,000

As a guide to the permissible losses in the armature punchings of D.C. machines, the following figures will be useful. They are based on modern practice and should not be greatly exceeded if the efficiency and temperature rise are to be kept within reasonable limits.

Output of machine	Core loss, expressed as percentage of output
10 kw.....	2.8 to 3.3
20 kw.....	2.5 to 3.0
50 kw.....	2.0 to 2.4
100 kw.....	1.5 to 1.8
500 kw.....	1.3 to 1.5
1,000 kw.....	1.2 to 1.4

**33. Ventilation of Armatures.**—Recent improvements in dynamo-electric machinery have been mainly along the lines of providing adequate means by which the heat due to power losses in the machine can be carried away at a rapid rate, thus increasing the maximum output from a given size of frame.

Still air is a very poor conductor of heat; but when a large volume of cool air is passed over a heated surface, it will effectually reduce the temperature which may, by this means, be kept within safe limits.

The rotation of the armature of an electric generator will produce a draught of air which may be sufficient to carry away the heat due to  $I^2R$  and hysteresis losses without the aid of a blower or fan. Self-ventilating machines are less common at the present time than they were a few years ago; but, by providing a sufficient number of suitably proportioned air ducts in the body of the armature, machines of moderate size may still be built economically without forced ventilation. Radial ducts are provided by inserting special ventilating plates at intervals of 2 to 4 in., and so dividing the armature core into sections around which the air can circulate. The width of these ventilating spaces (measured in a direction parallel to the axis of rotation) is rarely less than  $\frac{3}{8}$  in. or more than  $\frac{1}{2}$  in. in machines without forced ventilation. A narrower opening is liable to become choked up with dust or dirt, while the gain due to a wider opening is very small, and does not compensate for the necessary increase in gross length of armature. The ventilating plates usually consist of iron stampings similar in shape to the armature stampings, but thicker. Radial spacers of no great width, but of sufficient strength to resist crushing or bending, are riveted to the flat plates; they are so spaced as to coincide with the center of each tooth, and allow the air to pass outward by providing a number of small openings on the cylindrical surface of the armature.

Openings must also be provided between the shaft and the inside bore of the armature through which the cool air may be drawn to the radial ventilating ducts. The radial spacers on the ventilating plates assist the passage of the air through the ducts, their function being similar to that of the vanes in a centrifugal fan. Apart from the ventilating ducts, the outer cylindrical surface of the armature is effective in getting rid of a



large amount of heat, and the higher the peripheral velocity of the armature, the better will be the cooling effect.

When forced ventilation is adopted, a fan or centrifugal blower may be provided at one end of the armature. This may assist the action of radial ventilating ducts, or it may draw air through axial ducts. When axial air ducts are provided, the radial ventilating spaces are omitted, and the gross length of the armature may therefore be reduced. The ventilation is through holes punched in the armature plates which, when assembled, will provide a number of longitudinal openings running parallel with the armature conductors. These openings may be circular in section and should not be less than 1 in. in diameter, especially when the axial length of the armature is great, because they will otherwise offer too much resistance to the passage of the air, and will also be liable to become stopped up with dirt.

One advantage of axial ducts—which, however, can only be used with forced ventilation—is that the heat from the body of the armature can travel more easily to the surface from which the heat is carried away than in the case of radial ducts. When the cooling is by radial ducts, the heat due to the hysteresis and eddy-current losses in the core must travel not only through the iron, which is a good heat conductor, but also through the paper or other insulation between laminations, which is a poor conductor of heat. As a rough approximation, it may be said that the thermal conductivity of the assembled armature stampings is fifty times greater in the direction parallel to the plane of the laminations than in a direction perpendicular to this plane. For this reason, radial vent ducts, to be effectual, must be provided at frequent intervals. The thickness of any one block of stampings between radial vent ducts rarely exceeds 3 in.

The coefficients for use in calculating temperature rise are based on data obtained from actual machines, and owing to variations in design and proportions they are at the best unreliable. When forced ventilation is adopted—whether with radial or axial vent ducts—it is possible to design the fans or blowers to pass a given number of cubic feet of air per second, and the quantity can readily be checked by tests on the finished machine. The design of such blowers does not come within the scope of this book, neither is it possible to discuss at length the whole subject of ventilation and temperature rise. For a more complete study of this problem, the reader is referred to other

sources of information. A very good treatment of the subject will be found in Chaps. IX and X of PROFESSOR MILES WALKER'S recently published book on dynamo-electric machinery.<sup>1</sup>

A good practical rule for estimating the quantity of air necessary to carry away the heat when forced ventilation is used is based on the fact that a flow of 1 cu. ft. of air per minute will carry heat away at the rate of  $0.536T$  watts, where  $T$  is the number of degrees Centigrade by which the temperature of the air has been increased while passing over the heated surfaces. Thus, if the difference in temperature between the outgoing and incoming air is not to exceed  $19^{\circ}\text{C}$ ., it will be necessary to provide at least 100 cu. ft. of air per minute for each kilowatt lost in the machine.

The power required to drive the ventilating fan is not very easily estimated as it depends upon the velocity of the air through the passages. The velocity of the air through the ducts and over the cooling surfaces is usually from 2,000 to 4,000 ft. per minute and should preferably not exceed 5,000 ft. per minute; with higher velocities the friction loss might be excessive.

As a very rough guide to the power required to drive the ventilating fans, the following figures may be useful:

For 50-kw. dynamo, 150 watts.

For 200-kw. dynamo, 500 watts.

For 1,000-kw. dynamo, 2,000 watts.

**34. Cooling Surfaces and Temperature Rise of Armature.**—Specifications for electrical machinery usually state that the temperature rise of any accessible part shall not exceed a given amount after a full-load run of about 6 hr. duration. The permissible rise of temperature over that of the surrounding air will depend upon the room temperature. It usually lies between  $40^{\circ}$  and  $50^{\circ}\text{C}$ . The surface temperature is actually of little importance and is no indication of the efficiency of a machine, but, by keeping the surface temperature below a specified limit, the internal temperatures are not likely to be excessive, and the durability of the insulation—upon which the life of the machine is largely dependent—will thereby be ensured. The designer must, however, see that ventilating ducts or surfaces are provided at sufficiently frequent intervals to allow of the heat

<sup>1</sup> MILES WALKER: "Specification and Design of Dynamo-electric Machinery," LONGMANS, GREEN & Co.



being carried away without requiring very great differences of temperature between the internal portions of the material where the losses occur and the surfaces in contact with the air. The thermal conductivity of all materials used in construction, and of the combinations of these materials, must be known before accurate calculations can be made on the internal temperatures; but, as an indication of how the insulation tends to prevent the passage of the heat to the cooling surfaces, the following figures are of interest. The figures in the column headed "Thermal conductivity" express the heat flow in watts per square inch of cross-section for a difference of 1°C. between parallel faces 1 in. apart.

Material	Thermal conductivity
Steel punchings, along laminations	1.6
Steel punchings, across laminations (8 per cent. paper insulation).....	0.038
Pure mica.....	0.0091
Built-up mica.....	0.0031 to 0.0026
Empire cloth, tightly wrapped (no air spaces).....	0.0063
Presspahn.....	0.0042

The maximum temperatures to which insulating materials may be subjected should not exceed the following limits:

Asbestos.....	500°C. or more
Mica (pure).....	500°C. or more
Micanite.....	125° to 130°C.
Presspahn, leatheroid, empire cloth, cotton covering, insulating tape, and similar materials.....	90° to 95°C.

If ventilating ducts are provided at sufficiently frequent intervals to ensure that the internal temperatures will not be greatly in excess of the surface temperatures, it is merely necessary to see that the cooling surface is sufficient to dissipate the watts lost in the iron and copper of the armature.

*Temperature Rise of Self-ventilating Machines.*—In calculating the losses and the cooling surfaces of the armature, we shall assume that the current density in the conductors has been so chosen that the end connections will not be appreciably hotter than the armature as a whole. If this density does not exceed the value as calculated by formula (51) of Art. 29, it may be assumed that the temperature rise of the end connections will

not exceed 40°C., and the watts to be dissipated by the cooling surfaces of the armature core will consist of:

1. The hysteresis and eddy-current losses in the teeth.
2. The hysteresis and eddy-current losses in the core below the teeth.
3. The  $I^2R$  losses in the "active" portion of the armature winding.

All these losses can be calculated in the manner previously explained. The copper loss to be taken into account is not the total  $I^2R$  loss in the armature winding, but is this total loss multiplied by the ratio  $\frac{2l_a}{2l_a + l_e}$ , where  $l_a$  is the gross length of the armature core, and  $l_e$  is the length of the end connections of one coil, as calculated by formula (52) of Art. 29.

The various cooling surfaces may be considered separately, and the watts carried away from each surface computed independently. The total cooling surface may conveniently be divided into:

1. The outside cylindrical surface of the (revolving) armature.
2. The inside cylindrical surface over which the air passes before entering the radial cooling ducts.
3. The entire surface of the radial ventilating ducts, and the two ends of the armature core.

The cooling effect of the external surface at the two ends of the armature core is generally similar to that of the radial ventilating spaces, and it is convenient to think of the two end rings as being equivalent to an extra duct. Thus, in Fig. 35, the number of ducts is shown as five, and the cooling surface of each duct (both sides) is  $\frac{\pi}{2}(D^2 - d^2)$ . The calculations would be made on the assumption that there are six ducts. If the number of radial vent ducts provided is  $n$ , the total cooling surface of the ducts and the two ends of the armature will be

$$\frac{\pi}{2}(D^2 - d^2)(n + 1).$$

The outside cylindrical surface of the armature will be taken as  $\pi D l_a$ , where  $l_a$  is the gross length, no deduction being made for the space taken up by the vent ducts. The cooling surface of the end connections beyond the core is not taken into account.

The area of the inside cylindrical surface is  $\pi d l_a$ .



The watts dissipated by the cylindrical cooling surfaces may be calculated by the formula

$$W = TA \left( \frac{1,500 + v}{100,000} \right) \quad (53)$$

where  $W$  = the watts dissipated.

$T$  = the surface temperature rise in degrees Centigrade.

$A$  = the cooling area in square inches.

$v$  = the peripheral velocity in feet per minute.

This formula is generally similar to one proposed some years ago by DR. GIBBERT KAPP.

If  $w_c$  is a cooling coefficient representing the watts that can be dissipated per square inch of surface for 1°C. difference of temperature, we have

$$w_c = \frac{1,500 + v}{100,000} \quad (54)$$

and the temperature rise will be

$$T = \frac{W}{w_c A}$$

where  $W$  stands for the watts that have to be dissipated through the cooling surface  $A$ .

The watts dissipated by the air ducts and end surfaces may be calculated by the formula

$$W = TA \frac{4v_d}{100,000} \quad (55)$$

where  $W$ ,  $T$ , and  $A$  have the same meaning as before, but  $v_d$  stands for the average velocity of the air through the ducts in feet per minute. This velocity is very difficult to estimate in the case of self-ventilating machines, but the constant in the formula has been selected to give good average results if  $v_d$  is taken as one-tenth of the peripheral velocity of the armature.

If  $w_d$  is a cooling coefficient representing the watts that can be dissipated per square inch of duct surface for each degree Centigrade rise of temperature, we have

$$w_d = \frac{4v_d}{100,000} \quad (56)$$

and the temperature rise of the vent duct surfaces will be

$$T = \frac{W}{w_d A}$$

where  $W$  stands for the watts that have to be dissipated through the surface of area  $A$ .

*Example.*—In order to explain the application of the formulas for armature heating, numerical values will be assumed for the dimensions in Fig. 35.

Let  $D = 32$  in.,  
 $d = 23$  in.,  
 $l_a = 15$  in.,  
 $n = 5$  (the number of air ducts in the armature core),  
 $N = 400$  revolutions per minute,

whence

$$v = 400 \times \frac{32\pi}{12} = 3,360$$

and

$$v_a = 336.$$

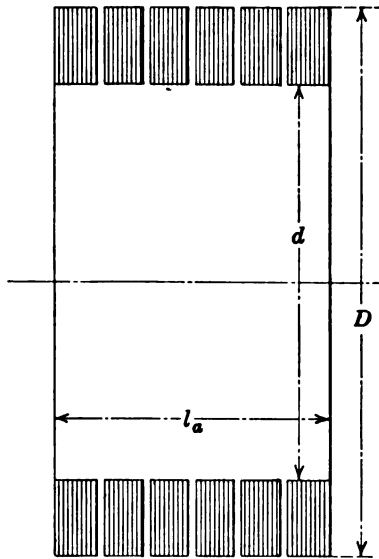

FIG. 35.—Section through armature core.

Let us further assume that the total armature losses, consisting of hysteresis and eddy-current losses in teeth and core, together with the  $I^2R$  losses in the portion of the armature winding that is buried in the slots, amount to 7 kw.

The cooling surfaces to be considered are:

1. The outside cylindrical surface of area  $A_1 = \pi \times 32 \times 15 = 1,510$  sq. in.
2. The inside cylindrical surface of area  $A_2 = \pi \times 23 \frac{1}{2} \times 15 = 1,085$  sq. in.

3. The ventilating duct surface, including the two ends of the armature coil, of area  $A_2 = \frac{\pi}{2} (32^2 - 23^2) (5 + 1) = 4,680$  sq. in.

The radiating coefficients to be used are calculated by formulas (54) and (56); thus, for surface (1),

$$w_c = \frac{1,500 + 3,360}{100,000} = 0.0486$$

and the watts that can be dissipated per degree rise of temperature are

$$\begin{aligned} W_1 &= w_c A_1 \\ &= 0.0486 \times 1,510 = 73.4 \end{aligned}$$

For surface (2),

$$w_c = \frac{1,500 + \left(3,360 \times \frac{23}{32}\right)}{100,000} = 0.0391$$

and the watts that can be dissipated per degree rise of temperature are

$$\begin{aligned} W_2 &= w_c A_2 \\ &= 0.0391 \times 1,085 = 42.5 \end{aligned}$$

For surface (3),

$$w_d = \frac{4 \times 336}{100,000} = 0.01344$$

and the watts that can be dissipated per degree rise of temperature are

$$\begin{aligned} W_3 &= w_d A_3 \\ &= 0.01344 \times 4,680 = 63 \end{aligned}$$

The total watts that can be dissipated per degree rise of temperature are  $73.4 + 42.5 + 63 = 178.9$ ; whence the rise in temperature to be expected will be

$$\frac{7,000}{178.9} = 38.9^\circ\text{C}.$$

*Temperature Rise of Machines with Forced Ventilation.*—When a machine is designed for forced ventilation, suitable ducts—whether radial or axial—must be provided in the armature, and the frame must be so arranged as to provide proper passages for the incoming and outgoing air. The fan or blower may be outside or inside the enclosing case. It is usual to allow 100 cu. ft. of air per minute for every kilowatt lost in heating the arma-

ture and field coils of the machine. This will result in a difference of about  $20^{\circ}\text{C}$ . between the average temperatures of the outgoing and incoming air.

In order to ensure that there shall be no unduly high local temperatures in the machine, the air ducts or passages must be suitably proportioned, and provided at frequent intervals. When the paths followed by the air through the machine, and the cross-section of these air channels, are known, the average velocity of the air over the heated surfaces can be calculated. Formula (56) can then be used for determining approximately the difference in temperature between the cooling surfaces and the air.

**35. Summary, and Syllabus of Following Chapters.**—All necessary particulars have been given in this and the foregoing chapters for determining approximately the dimensions and windings of an armature suitable for a given output at a given speed. A suggested method of procedure in design will be explained later; but, so far as the preliminary design of the armature is concerned, the dimensions are determined by using an output formula (Art. 19, Chap. IV) and deciding upon the diameter  $D$  and the length  $l_a$  of the armature core. When proportioning the slots to accommodate the winding, the diameter  $D$  should be definitely decided upon, but slight alterations in the length  $l_a$  can readily be made later if it is found necessary to modify the amount of the flux per pole ( $\Phi$ ) or the air-gap density ( $B_g$ ). Once the calculations for temperature rise have been made, and the design so modified—if necessary—as to keep this within  $40^{\circ}$  to  $45^{\circ}\text{C}$ ., the dimensions of the armature will require no further modification. The question of commutator heating will be taken up later; but, in designing the armature for a given temperature rise, the assumption is made that no appreciable amount of heat will be conducted to or from the commutator through the copper lugs connecting the armature winding to the commutator bars.

The flux per pole necessary to generate the required voltage being known, the remainder of the problem consists in designing a field system of electromagnets capable of providing the required flux in the air gap. This problem is similar to that of designing an electromagnet for any other purpose, and it has been considered in some detail in Chaps. II and III. It might appear, therefore, that little more need be said in connection with

the design of a continuous-current generator, but it must be remembered that certain assumptions were made in order that the broad questions of design might not be obscured by too much detail, and in order also that the leading dimensions of the machine might be decided upon.

It was assumed that the flux in the air gap was uniformly distributed under the pole face; but is it so distributed, and if not, how does this affect the tooth saturation and the ampere-turns required to overcome the reluctance of the teeth and gap? What is the influence of the air-gap flux distribution on armature reaction and voltage regulation, and how can we calculate the field excitation required at different loads in order that the proper terminal voltage may be obtained? These and similar questions cannot be answered without a more thorough study of the magnetic field cut by the conductors, at full load as well as on open circuit.

Again, with a non-uniform field under the poles, the flux density in the teeth may be much higher than would be indicated by calculations based on a uniform field, and this might lead to excessive heating.

Perhaps the most important problem in the design of direct-current machines is that of commutation which, so far, has barely been touched upon. It is proposed to devote a whole chapter to the study of commutation phenomena.

These various matters will be taken up in the following order: First, a study of the flux distribution over the armature surface, and what follows therefrom in relation to tooth densities, regulation, and the excitation required at various loads; next, commutation and the design of commutating poles; and finally, some notes on the design of the field system, with a brief reference to the factors that must be taken into account when calculating the efficiency of a continuous-current generator.



## CHAPTER VII

### FLUX DISTRIBUTION OVER ARMATURE SURFACE

An experienced designer may go far and obtain good results without resorting to the more or less tedious process of plotting flux-distribution curves; but occasions arise when his experience and judgment fail him, and when a reasonably accurate method of predetermining the distribution of flux density over the surface of the armature would give him all necessary information. A method of designing electric machinery—whether continuous-current dynamos or alternating-current generators—which involves the plotting of the flux distribution curves, has much to recommend it, not only to the student, but also to the professional designer. The advantage from the student's point of view is that a more accurate conception of the operating conditions can be obtained than by using empirical formulas, or making the unscientific assumptions which are otherwise necessary. The designer will be glad to avail himself of a practical method of plotting flux curves when departures have to be made from standard models, or when it is desired to investigate thoroughly the effects of cross-magnetization upon commutation or pressure regulation.

#### **36. Air-gap Flux Distribution with Toothed Armatures.—**

The determination of the flux densities in all parts of the tooth and slot for various values of the average air-gap flux density is so difficult and complicated that it is safe to say no correct mathematical solution may be looked for, although empirical rules and formulas of great practical value may serve the purpose of the designer.

The reluctance of the magnetic paths between pole face and armature core can be calculated with but little error for the two extreme cases of very low and very high average flux density over the tooth pitch; but for intermediate values the designer has still to rely on his judgment, based on familiarity with the laws of the magnetic circuit.

To calculate the permeance of the air paths over one slot pitch at the center of the pole face, when the density is low, the magnetic lines are supposed to follow the paths indicated in

Fig. 36. The tooth is drawn, for convenience, with parallel sides, and the magnetic lines entering the sides of the tooth are supposed to follow a path consisting of a straight portion of length  $\delta$ , equal to the actual clearance, and a circular arc of radius  $r$ , all as indicated in the figure. This is obviously an arbitrary assumption, but it is convenient for calculation and gives very good results. It agrees very closely with the results obtained by MESSRS. H. S. HELE-SHAW, ALFRED HAY, and P. H. POWELL in their classic Institution paper<sup>1</sup> and also with the

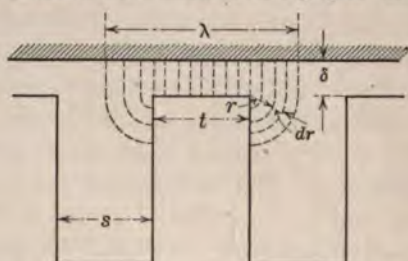

FIG. 36.—Flux lines entering toothed armature. (Low flux density.)

correct mathematical conclusions arrived at by MR. F. W. CARTER<sup>2</sup> based on certain assumptions, including that of infinite permeability of the iron in the teeth.

Considering a portion of the air gap 1 cm. long axially (*i.e.*, in a direction normal to the plane of the section shown in Fig. 36), the permeance over the slot pitch of width  $\lambda$  is seen to be made up of two parts: (1) the permeance  $P_1$  between pole face and top of tooth, of value  $P_1 = \frac{t}{\delta}$ , and (2) the permeance  $2P_2$  where  $P_2$  is the permeance between the pole face and one side of the tooth. Consider any small section of thickness  $dr$  as indicated in Fig. 36. The permeance of such a path, of depth 1 cm. measured axially, is

$$\begin{aligned} dP_2 &= \frac{dr}{\delta + \frac{\pi}{2}r} \\ &= \frac{2}{\pi} \times \frac{dr}{\left(\frac{2\delta}{\pi}\right) + r} \end{aligned}$$

<sup>1</sup> "Hydrodynamical and Electromagnetic Investigations Regarding the Magnetic-flux Distribution in Toothed-core Armatures," *Proc. Inst. E. E.*, vol. 34, p. 21.

<sup>2</sup> *Electrical World*, vol. 38, Nov. 30, 1901, p. 884.

and

$$P_2 = \frac{2}{\pi} \int_0^{\frac{s}{2}} \frac{dr}{\frac{2\delta}{\pi} + r}$$

$$= \frac{2}{\pi} \log_e \frac{\delta + \frac{\pi s}{4}}{\delta}$$

The average permeance *per square centimeter* over the slot pitch at center of pole is, therefore,

$$P_{e. cm.} = \frac{P_1 + 2P_2}{(t + s)}$$

$$= \frac{\frac{t}{\delta} + \frac{4}{\pi} \log_e \left( \frac{\delta + \frac{\pi s}{4}}{\delta} \right)}{t + s} \tag{57}$$

The reciprocal of this quantity is the reluctance per square centimeter of cross-section, or the equivalent air-gap length  $\delta_e$ . Thus

$$\delta_e = \frac{t + s}{\frac{t}{\delta} + \frac{4}{\pi} \log_e \left( \frac{\pi s}{4\delta} + 1 \right)} \tag{58}^1$$

Consider now Fig 37, which illustrates the case of a highly saturated tooth. The lines of flux are shown parallel over the

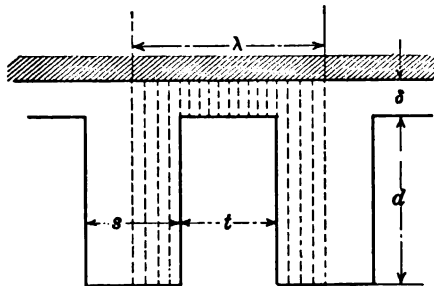

FIG. 37.—Flux lines entering toothed armature. (High flux density.)

whole of the slot pitch, a condition which is approached—but never attained—as the density in the tooth is forced up to higher and higher values. It is obviously only when the permeability

<sup>1</sup> If the ventilating ducts are closely spaced, or exceptionally wide, the gap,  $\delta_e$ , for the equivalent smooth-core armature, as given by formula (58), might have to be slightly modified; but the calculation of fringing at the sides of vent ducts is usually an unnecessary refinement.

of the iron in the tooth becomes equal to unity—that is to say, equal to the permeability of the air paths—that this parallelism of the flux lines would occur, and the equivalent air gap would be  $\delta_e = \delta$ , to which would have to be added another air gap of length  $d$  (Fig. 37) to represent the reluctance of the teeth and slots. This is an extreme, and indeed an impossible, condition; but, since the actual distribution of the lines of flux in tooth and slot cannot be predetermined, the calculations for very high densities are usually made by assuming the flux lines to be parallel, as indicated in Fig. 37. It is when this assumption is made for low values of the density that appreciable errors are likely to be introduced. The following method of calculating the joint reluctance of tooth and slot should not be used for tooth densities below 20,000 gausses.

Considering 1 cm. only of axial net length of armature core (*i.e.*, 1 cm. total thickness of iron), the reluctance of the air gap and tooth, taken over the width of one tooth only, is,

$$R_1 = \frac{\delta}{t} + \frac{d}{\mu t} = \frac{(d + \mu\delta)}{\mu t}$$

The reluctance of the slot portion of the total tooth pitch is,

$$R_2 = \frac{(d + \delta)}{s}$$

The air gap of the equivalent smooth-core armature—being the reluctance per square centimeter or the reciprocal of the permeance per square centimeter—is, therefore,

$$\delta_e = \frac{(t + s)}{\frac{1}{R_1} + \frac{1}{R_2}}$$

which can be put in the form,

$$\delta_e = \frac{(t + s)(d + \delta)}{\mu t \left( \frac{d + \delta}{d + \mu\delta} \right) + s} \quad (59)$$

This equivalent air gap includes the reluctance of the tooth itself when the flux density is high, but does not take account of the flux in the vent ducts and spaces between stampings. It is seen to depend upon the permeability of the iron, and, therefore, upon the actual flux density in the tooth. In order to make use of formula (59), a value for the flux density in the tooth must be assumed. A method of working which involves a change in the



equivalent air gap for various values of the flux density would be unpractical, and, since no exact method is ever likely to be developed, some sort of compromise must be made.

*Length of Air Gap.*—The air-gap clearance  $\delta$  must, of course, be decided upon before the calculation of tooth and slot reluctance can be made. The controlling factor in determining this clearance is the armature strength or the ampere-turns per pole of the armature. If the m.m.f. due to the armature greatly exceeds the excitation on the field poles, there will be trouble due to field distortion under load, which will lead to poor regulation and commutation difficulties. The field ampere-turns at full load should be greater than the armature ampere-turns. A safe rule is to provide an air gap such that the open-circuit ampere-turns required for the air gap alone—assuming a smooth core and no added reluctance due to slots—would be equal to the ampere-turns on the armature at full load. Thus if  $(SI)_g$  are the ampere-turns per field pole required to overcome the reluctance of an air gap of length  $\delta$ , we may write  $(SI)_g = (SI)_a$  where  $(SI)_a$  stands for the armature ampere-turns as calculated by formula (48) page 80. This gives for  $\delta$  the value:

$$\delta = \frac{(SI)_a \times 0.4\pi}{2.54B_g} \text{ in.}$$

or, approximately,

$$\delta = \frac{1}{2} \frac{(SI)_a}{B_g} \text{ in.}$$

where  $B_g$  may be taken as the apparent flux density in the air gap under the pole face on the assumption that there is no fringing. (For approximate values of  $B_g$ , refer to the table on page 75.)

The length of air gap may be somewhat reduced if commutating interpoles are provided, especially if pole-face windings (see Art. 50, Chap. VIII) are used.

Another factor which may influence the air-gap clearance is the possibility of unbalanced magnetic pull due to slight decentralization of the armature. This becomes of importance only in machines of large diameter with many poles and rarely necessitates a clearance greater than that obtained by applying the above rule.

**37. Actual Tooth Density in Terms of Air-gap Density.**—It is convenient to think of the reluctance of air gap, teeth, and



slots as consisting of two reluctances in series, (a) the reluctance of the equivalent air gap (as calculated by formula (58) for the center of the pole face), and (b) the reluctance of the tooth. The calculation of this latter quantity depends upon a knowledge of the actual flux density in the tooth. For low densities in the iron—up to about 20,000 gausses—the actual tooth density will be approximately equal to the apparent density; that is to say, practically all the flux entering the armature over one tooth pitch will pass into the core through the root of the tooth. For densities exceeding 20,000 gausses, a closer estimate of the correct value of the tooth density may be made by assuming the condition of Fig. 37.

Let the meaning of the symbols be as follows:

$B_o$  = the average air-gap flux density at armature surface;  
*i.e.*, the average density over one tooth pitch of width  
 $t + s$  and length  $l_a$ .

$B_i$  = the actual tooth density.

$B_s$  = the density in the slot and air spaces.

$\Phi_\lambda$  = the total flux entering armature core in the space  
of one slot pitch.

$l_n$  = the net length of the armature core (iron only).

The other dimensions as given on the sketch Fig. 37.

If the assumption is made that the lines of flux lie in a plane exactly perpendicular to the axis of rotation, it might be argued that the flux in the ventilating ducts and in the insulating spaces between the iron laminations does not enter the iron of the armature core; and the reluctance of the paths followed by this flux would therefore be very high. This argument is not justified since the flux lines in the ventilating ducts will actually find their way into the core immediately below the bottom of the slots, even if the iron in the teeth is practically saturated. We shall therefore assume two equipotential surfaces, one being the pole face and the other being the cylindrical surface passing through the roots of the teeth. The flux density in the air ducts and spaces not occupied by iron will therefore be the same as the density,  $B_s$ , in the slots, and the m.m.f. required to overcome the reluctance of air gap proper and slot will be the same as the m.m.f. required to overcome the reluctance of air gap proper and tooth; therefore

$$B_s(d + \delta) = B_i \left( \frac{d}{\mu} + \delta \right)$$

whence 
$$B_s = B_t \left( \frac{d + \mu\delta}{\mu(d + \delta)} \right) \tag{60}$$

Considering, now, the total flux entering the armature over one slot pitch, this is made of two parts:

1. The flux in the iron of the teeth, of value  $B_t l_n$ .
2. The flux in the slots and ducts, of value

$$B_s [sl_a + t(l_a - l_n)]$$

or

$$B_s (l_a \lambda - l_n t)$$

The total flux entering through one slot pitch can also be expressed in terms of  $B_g$ , being:

$$\Phi_\lambda = B_g \lambda a$$

Thus

$$B_g \lambda a = B_t l_n + B_s (\lambda a - t l_n) \tag{61}$$

Substituting in (61) the value for  $B_s$  given by formula (60) in terms of  $B_t$ , and solving for  $B_g$ , we get:

$$B_g = B_t \left[ \frac{l_n}{\lambda a} + \left( \frac{d + \mu\delta}{\mu(d + \delta)} \right) \left( 1 - \frac{t l_n}{\lambda a} \right) \right] \tag{62}$$

By assuming values of  $B_t$  ranging between 20,000 and (say) 26,000 gausses, the corresponding values of  $B_g$  can be calculated by formula (62), and a curve plotted from which values of  $B_t$  can be found when  $B_g$  is known.

The fact that this formula is based on assumptions justified only if the value of  $B_t$  is very high should not be lost sight of. For very low values of  $B_t$  it may be assumed that all the flux entering through one slot pitch passes through the iron of the tooth. This leads to the expression:

$$B_t = B_g \left( \frac{\lambda a}{l_n} \right) \tag{63}$$

Curves may be plotted from the formulas (62) and (63) and a working curve, which shall be a compromise between these two extreme conditions, can then readily be drawn. This will be done when working out a practical design in a later chapter.

**38. Correction for Taper of Tooth.**—The assumption of parallel sides to the tooth is justified only when the diameter of the armature is large relatively to the slot pitch or when taper slots are used in order to provide a uniform cross-section throughout the whole length of the tooth. The dimension  $t$  in formula (62)

should, in the first place, be the width of the narrowest part of the tooth, as it is important that the density at this point be known; it rarely exceeds 25,000 gausses in continuous-current machines, and is less in alternators. When the field system revolves, as in most modern alternators, the armature teeth will usually be wider at the root than at the top, and but little error will be introduced by taking for  $t$  the average width, for the purpose of calculating the average density  $B$ , and the ampere-turns required for the teeth.

The case of a tooth with considerable taper, in which the density at root is in excess of 10,000 gausses, may be dealt with by the application of SIMPSON'S rule. Having determined the density  $B$ , at the root of the tooth, by applying formula (62) or (63) as the case may demand, the assumption is then made that the total flux in the tooth remains unaltered through other parallel sections.<sup>1</sup>

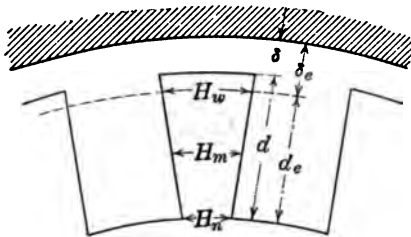

FIG. 38. Taper tooth.

The value of the magnetizing force  $H$  (or the ampere-turns required per unit length) can then be determined for any section of the tooth by referring to the  $B$ - $H$  curves for the iron used in the armature. It is sufficient to determine  $H$  for three sections only.

Let these values be:

$H_n$  at narrowest section

$H_w$  at widest section

$H_m$  at center (i.e., where the value of  $B_m$  is  $\frac{B_n + B_w}{2}$ )

<sup>1</sup> This is not a correct assumption when the root density is very high, because in that case flux will leak out from the sides of the tooth to the bottom of the slot; and at some distance from the bottom of slot (the taper being as indicated in Fig. 38) the total flux in the tooth will be greater than at the root cross-section.

Then, on the assumption that the portion of the  $B$ - $H$  curve involved is a parabola, SIMPSON'S approximation is,

$$\text{average } H = \frac{1}{6}H_n + \frac{2}{3}H_m + \frac{1}{6}H_w \tag{64}$$

Referring to Fig. 38, it will be seen that  $H_w$  is taken at the section which would be the top of the tooth if the air gap were increased from  $\delta$  to the "equivalent" value  $\delta_e$ , as calculated by formula (58). This is recommended as a good practical compromise; and the m.m.f. in gilberts required to overcome the reluctance of the tooth is  $H \times d_e$ , where  $d_e$ , the equivalent length of tooth, must be expressed in centimeters. If preferred, the formula (64) can be modified to give an average value of the necessary ampere-turns per inch.

**39. Variation of Permeance over Pole Pitch—Permeance Curve.**—The permeance per square centimeter of the air gap when the armature is slotted may be calculated for the center of the pole face, by using formula (57). This value will not change appreciably for other points under the pole shoe if the bore of the field magnets is concentric with the armature; but near the pole tips, and in the interpolar space, it will decrease at a more or less rapid rate, depending on the geometric configuration of

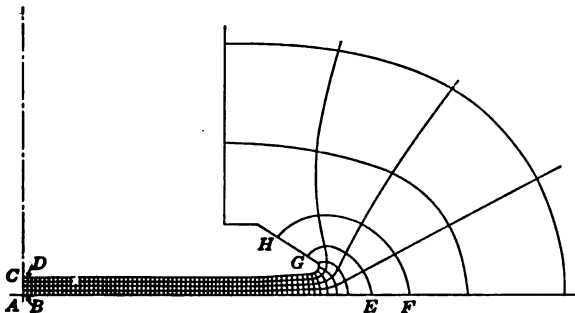

FIG. 39.—Flux lines in air gap of dynamo. (One pole acting alone.)

the pole pieces, and their circumferential width relatively to pole pitch and air-gap length. In considering the reluctance of the air paths between pole shoe and armature, it is convenient to think of an *equivalent* air gap of length  $\delta_e$ , as calculated by formula (58) of Art. 36; and in the following investigation the actual toothed armature must be thought of as being replaced by an imaginary smooth-core armature of the proper diameter to insure that the reluctance of the air gap per unit area at any

point on the periphery shall be the same as the average reluctance per unit area taken over the slot pitch.

In Figs. 39 and 40 an attempt has been made to represent the actual distribution of flux lines (1) for the condition of one pole acting alone without interference from neighboring poles, and (2) for the practical condition of neighboring poles of equal strength and opposite polarity. The machine to which these diagrams apply is a continuous-current dynamo of pole pitch 37 cm., pole arc 27 cm., and equivalent air gap of 0.8 cm. at center of pole face. The air gap is of uniform length except near the pole tips, where it is slightly increased, as indicated

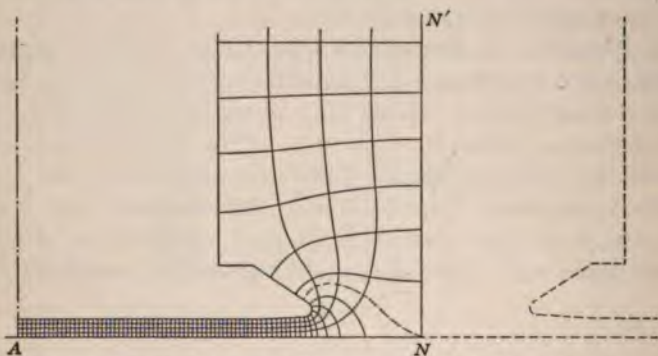

FIG. 40.—Flux lines in air gap of dynamo. (Effect of neighboring poles.)

on the drawings. With a little practice, unlimited patience, and ample time in which to perform the work, diagrams of flux distribution such as those of Figs. 39 and 40 can be drawn, and they will indicate accurately the actual arrangement of the flux lines. The method is one of trial and gradual elimination of errors, based on the well-known principle that the space distribution of the flux lines will be such as to correspond with maximum total permeance, or, in other words, such as will produce the maximum flux with a given m.m.f.

Probably one of the most practical and at the same time most accurate methods of procedure is that proposed by DR. LEHMANN<sup>1</sup> and followed in preparing the flux diagrams (Figs. 39, 40, 42 and 43). A section perpendicular to the shaft through the pole shoe and armature is considered, and all flux lines in

<sup>1</sup>“Graphische Methode zur Bestimmung des Kraftlinienverlaufes in der Luft,” *Elektrotechnische Zeitschrift*, vol. 30 (1909), p. 995.



the air gap are supposed to lie in planes parallel to this section. Equipotential lines are drawn in directions which seem reasonable to the draughtsman, and tubes of flux, *all having the same permeance*, are then drawn with their boundary lines perpendicular at all points to the equipotential lines. At the first trial it will generally be found that these conditions cannot be fulfilled, but by altering the direction of the tentative equipotential lines the work is repeated until the correct arrangement of lines is obtained. The tube of induction  $ABCD$  (Fig. 39) is the first to be drawn. Its permeance in the particular case considered is 0.25 because it consists of four portions in series, each one of which is exactly as wide as it is long (a thickness of 1 cm. measured axially is assumed). Proceeding outward from left to right, and making each section of the individual tube of induction exactly as wide as it is long, the permeance of every one of the component areas in the diagram is always unity, and any complete tube, such as  $EFGH$ , has the same permeance (in this example 0.25) as every other tube. The computation of the total permeance between the pole shoe and armature over any given area is thus rendered exceedingly simple. Although the armature surface is represented as a straight line in the accompanying illustrations, the actual curvature of the armature may be taken into account if preferred; but the error introduced by substituting the developed armature surface for the actual circle is generally negligible.

In Fig. 40 the flux lines have been drawn to ascertain the effect of the neighboring pole in altering the distribution over the armature surface in the interpolar space. The perpendicular  $NN'$  has been erected at the geometric neutral point, and may be considered as the surface of an iron plate forming a continuation of the armature surface  $AN$ . Thus  $ANN'$  will be an equipotential surface between which and the polar surface the intermediate equipotential surfaces must lie.

It may be mentioned that in Figs. 39 and 40, and also in the other flux-line diagrams, the pole core under the windings cannot properly be considered as being at the same magnetic potential as the pole shoe, relatively to the armature. The proper correction can be introduced in calculating the flux in each tube of induction; but since the present investigation is confined to the flux entering the armature from the pole shoe, it will not be necessary to make this correction.

The flux density at all points on the armature periphery is easily calculated when the flux lines have been drawn. Thus, since each tube of induction encloses the same number of magnetic lines, exactly the same amount of flux will enter the armature in the space  $EF$  (Fig. 39) as in the space  $AB$ . If  $B_{ab}$  is the flux density in the tube  $CDAB$  at the center of the pole face, the average density over the space  $EF$  will be

$$B_{ef} = B_{ab} \times \frac{AB}{EF}$$

Thus curves of flux distribution such as Fig. 41 can readily be drawn. It will be seen that the dotted curve, giving actual distribution of flux for the case of Fig. 40, does not differ from

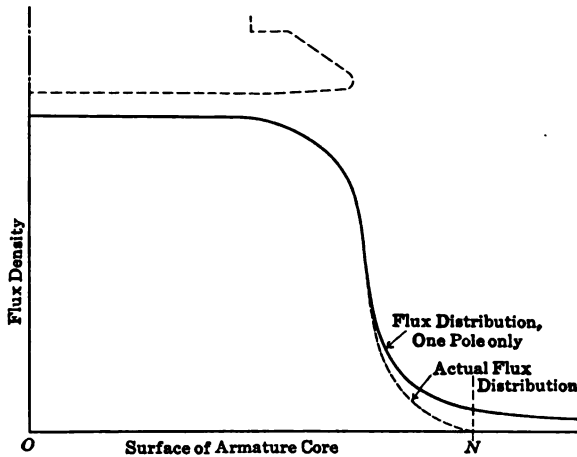

FIG. 41.—Curve of flux distribution over armature surface.

the full-line curve (case of Fig. 39, with no interference from neighboring poles) except in the interpolar space where the demagnetizing effect of the opposite polarity is appreciable, and causes the flux to diminish rapidly until it reaches zero value on the geometric neutral (the point  $N$ ), where its direction reverses. This is what one would expect to find, because, although the magnetic action of any one pole considered alone will extend far beyond each pole tip, this action will not be appreciable beyond the interpolar space, on account of the shading effect of the neighboring poles. In order to ascertain how far the demagnetizing effect of neighboring poles is likely to extend when the air gap is not constant but increases appreciably in

length as the distance from the center of the pole increases, the case of a salient pole alternator has been considered. The flux lines and equipotential surfaces for an alternator with shaped poles are shown in Figs. 42 and 43. The object of shaping the poles by gradually increasing the air gap from the center outward is to obtain over the pole pitch a distribution of flux which

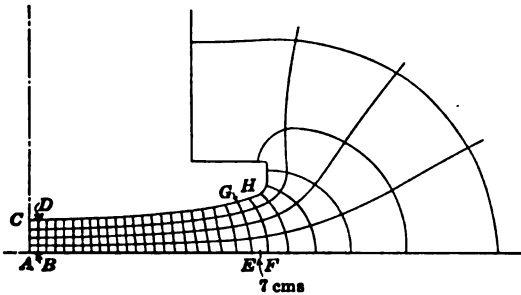

FIG. 42.—Flux lines in air gap of alternator. (One pole acting alone.)

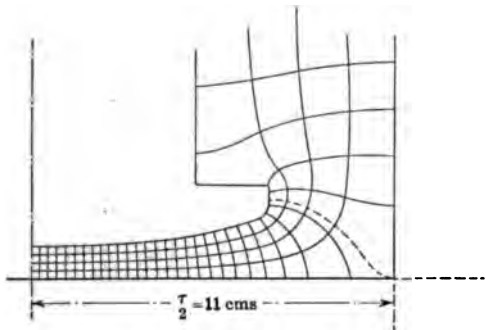

FIG. 43.—Flux lines in air gap of alternator. (Effect of neighboring poles.)

shall approximate to a sine curve. The data of the machine under consideration are as follows:

Pole pitch = 22 cm.

Pole arc = 14.3 cm.

Equivalent air gap at center of pole face  $\delta_e = 1$  cm.

Air gap at other points on armature surface =  $\frac{\delta_e}{\cos \theta}$  where

$\theta$  is the angle (in electrical degrees) between the center of the pole and the point considered.

In Fig. 44 the curve marked "permeance" has been plotted from Fig. 42. Its shape indicates the flux distribution over the armature surface on the assumption that the effect of neighbor-

ing poles is negligible. The m.m.f. between pole shoe and armature core being the same at all points on the armature surface, it is evident that this curve of flux distribution will correctly represent the variations of air-gap permeance per unit area of the armature surface. Thus, the permeance per square centimeter at the point 7 cm. from center of pole is the permeance of the tube  $GHEF$  in Fig. 42 divided by the area of the surface  $EF$ . The permeance of the tube  $GHEF$  is exactly the same as that of the tube  $CDAB$ , *i.e.*, 0.25 per centimeter of depth measured axially. The area of the surface  $EF$  is 0.5, and the permeance per square centimeter at the point considered is, therefore,

$$P_7 = \frac{0.25}{0.50} = 0.5.$$

**40. Open-circuit Flux Distribution and M.m.f. Curves.**—The dotted curve marked "flux" in Fig. 44 has been plotted from

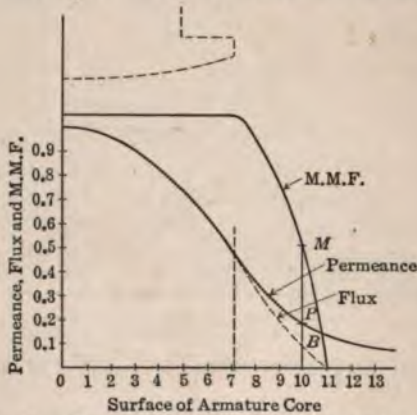

FIG. 44.—Curves of permeance, flux, and m.m.f.

Fig. 43, and shows the effect of the neighboring pole in reducing the air gap flux and causing it to pass through zero value at a point exactly halfway between the poles. A comparison of the full line and dotted flux curves shows that, even with the greatly increased air gap, the influence of the neighboring poles is not appreciable except in the uncovered spaces between the pole tips. The vertical dotted line in Fig. 44 shows the limit of the pole arc.

In order to find a scale for the flux curve it is necessary to know either the total flux entering the armature in the space



of a pole pitch or the m.m.f. between pole shoe and armature. If the resultant m.m.f. tending to send flux from the pole to any point on the armature is known, the flux density can be calculated because,  $B = \text{flux per square centimeter} = (\text{m.m.f.}) \times \text{permeance per square centimeter}$ .

Thus, if the m.m.f. necessary to overcome air-gap reluctance at center of the pole is known, the curve of resultant m.m.f. at all points on the armature can be plotted. This has been done in Fig. 44, where the ordinate of the m.m.f. curve at any point, such as 10, is simply  $10 - M = \frac{10 - B}{10 - P}$ , where the ordinate  $10 - B$  of the flux curve must be expressed in gausses.

**41. Practical Method of Predetermining Flux Distribution.**—Although the method outlined above, gives excellent results in the hands of an experienced designer who can afford the time required to map out the actual paths of the flux lines, it is not suitable for general use in actual designing work. By adopting a simple construction which assumes a certain flux distribution and avoids the drawing of equipotential lines, results of sufficient accuracy for practical purposes can very quickly be obtained.

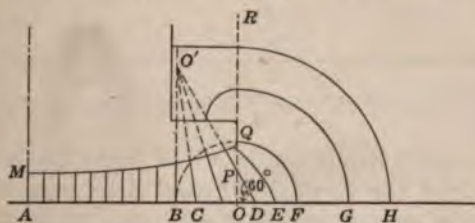

FIG. 45.—Approximate flux paths between pole and armature.

This construction is indicated in Fig. 45. A section through one-half of the pole shoe, showing the air gap in its proper proportion, is drawn to a sufficiently large scale, preferably full size. The “developed” armature surface may be used, in which case the construction is a little simpler because radial lines may be shown as perpendiculars erected on the horizontal datum line representing the armature surface. The distance  $AM$  is the “equivalent” air gap, as calculated for the center of the pole face by using formula (58). Draw the perpendicular  $OR$  tangent to the pole tip, and, through the first point of tangency  $Q$ , draw the semicircle  $BQF$  with its center at  $O$ . Bisect  $OQ$  at the point  $P$  and draw  $PD$  at an angle of 30 degrees



with  $OQ$ . Produce  $DP$  to  $O'$  where it meets the perpendicular erected on  $AD$  at the point  $B$ . Flux lines of which the length and direction will be approximately correct can now be drawn. All the lines from points on armature surface lying between  $A$  and  $B$  will be considered perpendicular to the armature surface, *i.e.*, verticals erected on the datum line. Between the points  $B$  and  $D$  the lines will be considered straight, but with a slope determined by the position of the point  $O'$  through which they will pass if produced beyond the pole face. From the point  $F$  the equivalent flux line will be the arc of the circle described through the point  $Q$  with the radius  $OQ$ , and lines from points between  $D$  and  $F$  must be put in by the eye so that their curvature shall be something between the circle through  $F$  and the straight line through  $D$ . One of these intermediate lines has been drawn from the point  $E$ . Over the region beyond  $F$  all flux

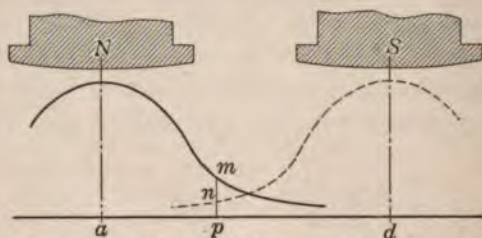

FIG. 46.—Effect of neighboring pole in modifying flux distribution.

lines will be drawn as circles described from the center  $O$  and continued beyond the vertical  $OR$  until they meet the pole in a direction normal to the surface of the iron. Thus the line from the point  $G$  is completed by an arc of circle with its center at the junction of the line  $OR$  and the flat surface of the polar projection, while the flux line from  $H$  is continued as a straight line (the shortest distance) until it meets the pole perpendicularly to the surface.

Any desired number of lines can very quickly be drawn in this manner, and they may be thought of as the center lines of "equivalent" tubes of flux of uniform cross-section over their entire length. If, now, the length of any one of these imaginary flux lines be measured in centimeters, the reciprocal of this length will be the permeance per square centimeter between pole shoe and armature at the point considered. It is, therefore, an easy matter to plot a permeance curve similar to the one

shown in Fig. 44. This curve, which represents the permeance per square centimeter of armature surface between pole and armature, can evidently be thought of as a flux-distribution curve on the assumption that one pole acts alone without interference from neighboring poles.

In regard to the actual flux distribution for no-load conditions, it may be argued that if two neighboring poles each acting alone would produce a flux distribution as shown respectively by the full-line and dotted curves of Fig. 46, then the flux at any point  $p$  will be  $pm - pn$ . This method of plotting the resulting flux-distribution curve should give satisfactory results in the space

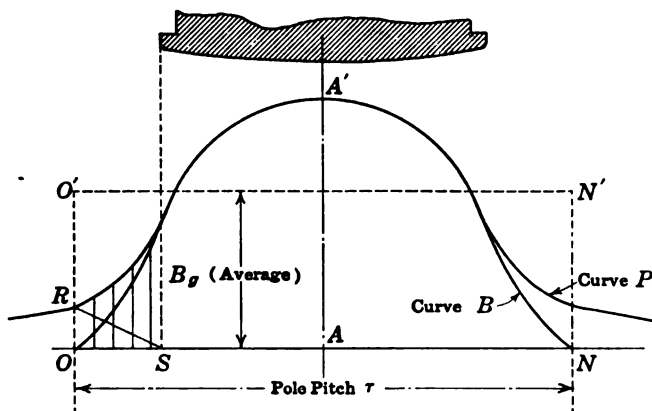

FIG. 47.—Practical construction for deriving flux curve from permeance curve.

between pole tips, but it does not provide for the gradual change in the flux distribution near the pole tips where the shading effect of the masses of iron becomes important. For the practical designer the writer recommends the approximation indicated in Fig. 47 where  $P$  is the permeance curve previously obtained. The flux curve is derived therefrom by drawing the straight line  $RS$ , connecting the point on the permeance curve directly over the geometric neutral to the point  $S$  immediately under the pole tip. By subtracting from the ordinates of the curve  $P$  the corresponding ordinates of the triangle  $ORS$ , the curve  $OA'N$  is obtained, representing the flux distribution on open circuit. This curve has yet to be calibrated, because the value of its ordinates cannot be determined unless either the m.m.f. or the total flux per pole is known. In designing a machine, the total

flux per pole will be known at this stage of the work, and the unknown factor will be the ampere-turns on the poles necessary to produce this flux. Measure the area of the curve  $OA'N$  and construct the rectangle  $OO'N'N$  of exactly the same area. The height of this rectangle will be a measure of the average density over the pole pitch. This is known to be

$$B_p \text{ (average)} = \frac{\Phi}{\tau \times l_a}$$

where  $\Phi$  = total flux per pole in the air gap.

$\tau$  = pole pitch in centimeters.

$l_a$  = gross length of armature in centimeters.

In this manner a scale is provided for the flux curve  $OA'N$ , which should preferably be replotted. The curve of resultant m.m.f. over armature surface can now be derived as explained in connection with Fig. 44.

Since the permeance curve as obtained by either of the methods here explained does not take into account the reluctance of the armature teeth, or indeed the reluctance of any part of the magnetic circuit other than the air gap, the actual ampere-turns necessary to produce the required flux will be greater than the amount indicated by the maximum ordinate of the m.m.f. curve of Fig. 44. The fact that the reluctance of the teeth at different points under the pole face is dependent upon the flux distribution tends to complicate the problem, but a method of accounting for this variation will be explained in the following article.

**42. Open-circuit Flux-distribution Curves, as Influenced by Tooth Saturation.**—Before considering the effect of the armature current in altering the distribution of magnetizing force over the armature periphery, it will be necessary to examine briefly how the degree of saturation of the teeth may be taken into account and a correct flux-distribution curve plotted. The method about to be explained is due to PROFESSOR C. R. MOORE, it is probably more easily applied and less tedious than an equally scientific method more recently proposed by DR. ALFRED HAY.<sup>1</sup>

In Fig. 48 a permeance curve has been drawn. It has the same meaning as the curve marked "Permeance" in Fig. 44 (Art. 39), and it may be obtained for any given machine in the manner described in Art. 41. If this curve (Fig. 48) has been

<sup>1</sup> A. HAY: "Predetermining Field Distortion in Continuous-current Generators," *Electrician*, 72, pp. 283-285, Nov. 21, 1913.

calibrated to read air-gap permeance per square centimeter of armature surface, it follows that, for a given value of m.m.f. between pole and armature, the flux density at any point—as for instance *d*—will be

$$B_d = (\text{m.m.f.})_d \times \text{value of ordinate of Fig. 48 at } d,$$

but in order to get the flux into the armature core the reluctance of the teeth must be considered.

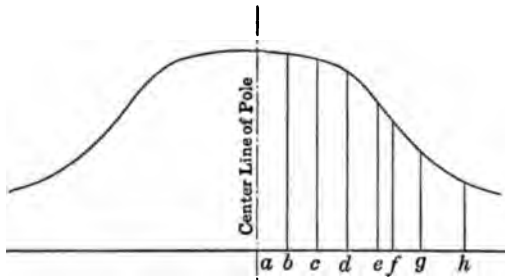

FIG. 48.—Permeance curve.

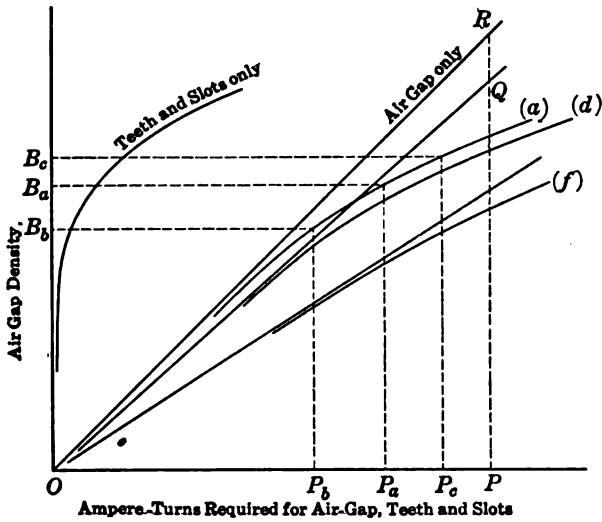

FIG. 49.—Saturation curves for air gap, teeth, and slots.

For any value of the air-gap density  $B_g$ , there is a corresponding value of the tooth density,  $B_t$ , which can be calculated by formula (62) or (63), as the case demands; and the ampere-turns required to overcome the reluctance of the tooth can be found, all as explained in Art. 38. This value can be plotted in Fig. 49



against the corresponding values of  $B_g$ , and the resulting curve shows the excitation required to overcome tooth reluctance for all values of the air-gap density. The curves for the air gap proper will all be straight lines when plotted in Fig. 49. Let  $OR$  be the curve for the point  $a$  at center of pole. Add the ampere-turns required for the teeth, and obtain curve (a), which gives directly the ampere-turns required to overcome reluctance of air gap, teeth, and slots, for all values of the air-gap density. It will be understood that the ordinates represent the average value of the air-gap density at armature surface

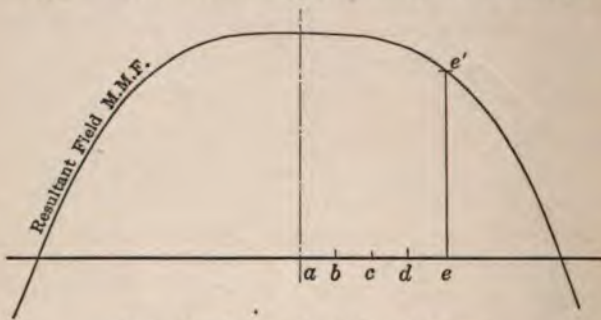

FIG. 50.—Open-circuit m.m.f. curve.

over a slot pitch. Any other curve, such as (d), is obtained by first drawing a straight line  $OQ$  such that  $PQ$  bears to  $PR$  the same relation as the ordinate at  $d$  in Fig. 48 bears to the ordinate at  $a$ , and then adding thereto the ampere-turns for the teeth, as already obtained. The curves of Fig. 49 should include a sufficient number of points on the armature surface; and when the resultant m.m.f. between armature points and pole is also known, the correct flux-distribution curves can readily be plotted.

Let the curve of Fig. 50 represent the distribution of the resultant field m.m.f. on open circuit obtained as explained in Art. 40 (Fig. 44); then, at any point such as  $e$ , the m.m.f. is given by the length of the ordinate  $ee'$ . Find this value on the horizontal scale of Fig. 49, and the height of the ordinate at this point, where it meets curve  $e$  (which is not drawn in Fig. 49), is the flux density, which can be plotted as  $ee'$  in Fig. 51. In this manner the flux curve  $A$  of Fig. 51 is obtained. The area of this curve, taken between any given points on the armature periphery, is obviously a measure of the total flux entering the armature between those points. The required flux per pole is



usually known. The average density over the pole pitch,  $\tau$ , as explained in Art. 41, is

$$B_g \text{ (average)} = \frac{\Phi}{\tau l_a}$$

where  $l_a$  is the gross length of armature.<sup>1</sup> By drawing the dotted rectangle of height  $B_g$  (average) as shown in Fig. 51, its area can be compared with that of curve *A* by measuring with a planimeter. If these areas are not equal, the ampere-turns per field pole, as represented by the curve of Fig. 50, must be altered and a new flux curve plotted, of which the area must indicate the required flux.

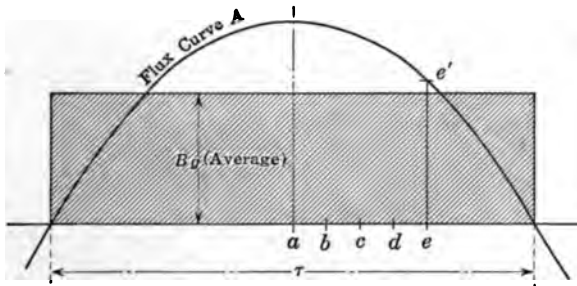

FIG. 51.—Open-circuit flux distribution.

**43. Effect of Armature Current in Modifying Flux Distribution.**

—The distribution of m.m.f. over armature surface when the field poles are acting alone has already been calculated and plotted in Fig. 50, and the effect of the armature current in modifying this distribution may be ascertained by noting that the armature ampere-turns between any two points such as  $d$  and  $d'$  on the armature circumference (see Fig. 52) are  $q(b - a)$ , where  $q$  stands for the specific loading or the ampere-conductors per unit length of armature circumference.

- Let  $p$  = number of poles,
  - $Z$  = total number of conductors on armature surface,
  - $I_c$  = current in each conductor,
  - $\tau$  = pole pitch,
- then  $q = \frac{ZI_c}{p\tau}$

<sup>1</sup> The gross length  $l_a$  of the armature core usually exceeds the axial length of the pole shoe by an amount equal to twice the air gap,  $\delta$ . Thus, by assuming the flux distribution as given by curve *A* of Fig. 51 to extend to the extreme ends of the armature, a practical allowance is made for the fringe of flux which enters the corners and ends of the armature core.

and the armature m.m.f. tending to modify the flux due to the field poles alone is

$$0.4 \pi \frac{ZI_c(b - a)}{p\tau}$$

between the points  $d$  and  $d'$ .

In order that a curve may be plotted on the same basis as the resultant field m.m.f. curve, it is necessary to know the armature m.m.f. per pole at all points. Let the distance between the points  $d$  and  $d'$  be equal to the pitch  $\tau$ ; then the effect of the armature m.m.f. at  $d'$  upon the pole  $S$  will be exactly the same as

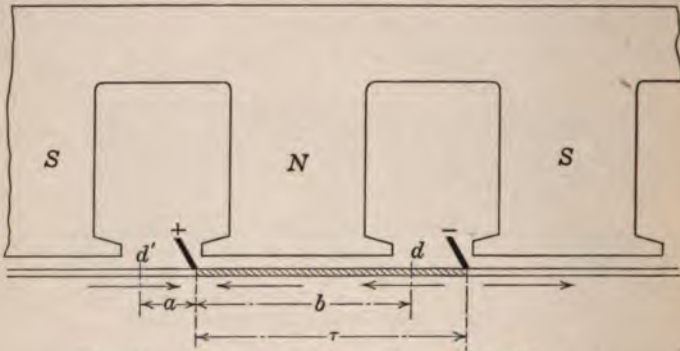

FIG. 52.—Magnetizing effect of armature inductors.

the effect of the armature m.m.f. at  $d$  upon the pole  $N$ , and the m.m.f. *per pole* at the point  $d$  may be expressed as

$$(\text{Armature m.m.f.})_d = \frac{0.4\pi ZI_c(b - a)}{2p\tau} \tag{65}$$

Its maximum value—which always occurs in the zone of commutation—is

$$\text{Armature m.m.f. per pole} = \frac{0.4\pi ZI_c}{2p} \tag{66}$$

The combination of this armature m.m.f. with the m.m.f. due to the field coils only, as represented by Fig. 50, is carried out graphically in Fig. 53. The curves  $F$  and  $A$  represent field and armature ampere-turns (or m.m.f. in gilberts, if preferred). These are the two components of a resultant m.m.f. curve,  $R$ , the ordinates of which are a measure of the tendency to send flux between any point on the armature surface and the pole shoe  $N$ . The actual value of the flux density at the various armature points under load conditions can therefore be obtained by using

the curves of Fig. 49 and plotting the values of air-gap density corresponding to the ampere-turns read off the curve *R* of Fig. 53. The procedure is exactly the same as when obtaining the open-circuit flux curve (Fig. 51) by using the values of Figs. 49 and 50, but the new curve of flux distribution—which may be called curve *B*, to distinguish it from the open-circuit flux curve *A*—gives the distribution over armature surface for a given brush position and a specified output. The difference in area of curves *A* and *B* is a measure of the flux lost through armature reaction; it includes not only direct demagnetization, but also cross-magnetization which—by producing distortion of the flux

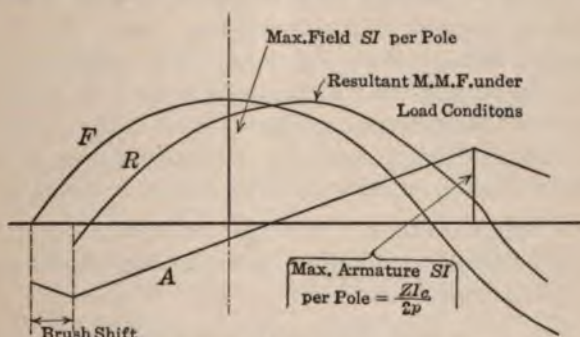

FIG. 53.—Addition of field and armature m.m.fs.

distribution—leads sometimes to local concentration of high densities and reduction of total flux owing to saturation of the iron in the armature teeth.

The final flux curve for the loaded machine is generally similar to curve *B*, except that its area must be such as to indicate that the desired voltage will be generated. This increased area is, of course, obtained by increasing the field ampere-turns. In other words, the curve *F* of Fig. 53 has to be replaced by a new open-circuit m.m.f. curve such that the new *R* curve resulting from its combination with the existing curve *A* will produce a new flux curve similar to *B*, but of the required area. This new flux-distribution curve may be called curve *C*, to distinguish it from the open-circuit curve *A* and also from the flux curve *B*, which, although a load curve, has too small an area to generate the required voltage. The amount by which the ordinates of curve *F* should be increased may be found by trial, but it is generally possible to estimate the necessary correction to give the required result.



The added field ampere-turns may be thought of as compensating for two distinct effects:

1. The loss of pressure due to armature reaction.
2. The loss of pressure due to  $IR$  drop in armature, brush contacts, and series field windings.

The correction for (1) consists in bringing the total flux up to its value on open circuit. It is the ampere-turns necessary to raise the air-gap density from its average value over curve  $B$  to its average value over curve  $A$ . An approximate method of making this correction is to find on curve ( $a$ ) of Fig. 49 (*i.e.*, the curve corresponding to point  $a$  at center of pole) the ampere-turns  $P_bP_a$  required to produce the difference of flux density  $B_bB_a$  when  $OB_b$  = average flux density over curve  $B$ , and  $OB_a$  = average flux density over curve  $A$ . The correction for (2) consists in increasing the flux per pole to such an extent that it will generate the increased voltage. This is the correction for compounding; it compensates for all internal loss of pressure, and must include over-compounding if this is called for.

If  $E'$  = required full-load *developed* volts, and

$E$  = open-circuit terminal volts (being also the no-load developed volts), then,

$$\frac{\text{Area of flux curve } C}{\text{Area of flux curve } A} = \frac{E'}{E}$$

In this manner the required area of curve  $C$  is obtained. The average flux density must be increased in this proportion, and the necessary additional ampere-turns for this correction are arrived at approximately by making  $P_aP_c$  (as indicated on Fig. 49) such as to increase the air-gap density in the ratio of  $E'$  to  $E$ .

The area of the final curve  $C$ , which should be measured for the purpose of checking with the required area, is that comprised between the points on the armature surface which correspond with the position of the brushes on the commutator, portions of the flux curve measured below the datum line being considered negative, and deducted from the area measured above the datum line.

The amount by which the area of the full-load flux curve  $C$  must exceed the area of the open-circuit flux curve  $A$  may be determined approximately by estimating the probable voltage drop in the series winding (if any) and at the brush-contact

surfaces. In the case of compound-wound machines, it will be known at the outset whether the dynamo is to be flat-compounded or over-compounded. Over-compounding is resorted to when the drop in the circuit fed by the machine is likely to be high. The terminal voltage may then be 5 per cent., or even 10 per cent., higher at full load than on open circuit. The balance of the e.m.f. to be developed at full load consists of:

1. The  $IR$  drop in armature winding.
2. The  $IR$  drop in series field (if any).
3. The  $IR$  drop in interpole winding (if any).
4. The  $IR$  drop at brush-contact surface.

Item (1) can readily be calculated since the armature winding has been designed. Item (2) may be estimated at from one-fourth to one-half the armature drop. Item (3) may be estimated at from one-fourth to one-half the armature drop. Item (4) will be discussed later, but it may be estimated at 2 volts, and is practically constant for machines of widely different voltages and outputs.

By totalling these items of internal loss of pressure, and adding thereto the required difference between the *terminal* volts at full load and at no load, the full-load developed voltage  $E'$  is obtained, and the required area of curve  $C$  is therefore:

$$\text{Area of open-circuit flux curve } A \times \frac{E'}{E}$$

where  $E$  is the open-circuit terminal voltage as previously defined.

The ampere-turns necessary to produce the curve  $C$  of this particular area will not be far short of the total ampere-turns on the field coils at full load, because the air gap, teeth and slots have considerably greater reluctance than the remainder of the magnetic circuit. The extra ampere-turns required to overcome the reluctance of the armature core, magnet limbs and frame will be considered later when dealing with the magnetic circuit as a whole and the field-magnet windings.



## CHAPTER VIII

### COMMUTATION

**44. Introductory.**—A continuous-current dynamo is provided with a commutator in order that unidirectional currents may be drawn from armature windings in which the current actually alternates in direction as the conductors pass successively under poles of opposite kind.

As each coil in turn passes through the zone of commutation, it is short-circuited by the brush, and during the short lapse of time between the closing and the opening of this short-circuit the current in the coil must change from a steady value of  $+I_c$  to a steady value of  $-I_c$ .

Let  $W$  = surface width of brush (brush arc) in centimeters.

$M$  = thickness of insulating mica in centimeters.

$V_c$  = surface velocity of commutator in centimeters per second.

The time of commutation, in seconds, may then be written,

$$t_c = \frac{W - M}{V_c}$$

Since  $M$  is usually small with reference to  $W$ , it is generally possible to express the time of commutation as  $t_c = \frac{W}{V_c}$ ; that is to say, the time taken by any point on the commutator surface to pass under the brush is approximately the same as the duration of the short-circuit. It is during this time,  $t_c$ , that the current in the commutated coil must pass through zero value in changing from the full armature current of value  $+I_c$  to the full armature current of value  $-I_c$ . If  $R$  is the resistance of the short-circuited coil, and if any possible disturbing effect of brush-contact resistance be neglected, it is evident that the e.m.f. in the coil should be  $e = I_c \times R$  at the commencement of commutation. At the instant of time when the current is changing its direction—*i.e.*, when no current is flowing in the coil—the e.m.f. is  $e = 0 \times R = 0$ . At the end of the time

$t_c$ , when the coil is just about to be thrown in series with the other coils of the armature winding carrying a current of  $-I_c$  amp., the e.m.f. in the coil should be  $e = -I_c R$ . It is when the e.m.f. in the coil has some value other than this theoretical value that sparking is liable to occur.

The theoretical investigation of commutation phenomena is admittedly difficult, because it is almost impossible to take account of the many causes which lead to sparking at the brushes. Some of the problems to be dealt with are of a purely mechanical nature, and it is necessary to make certain assumptions and to disregard certain influencing factors in order that the essential features of the problem of commutation may be studied. The writer has deliberately departed from the usual method of treating this subject because he believes that it is possible to put the fundamental principles involved into a somewhat simpler form than they are likely to assume when clothed in mathematical symbolism. An attempt will be made to obtain a clear conception of the physical phenomena involved in the theory of commutation.

Before the publication of MR. LAMME'S paper<sup>1</sup> the methods of DR. STEINMETZ<sup>2</sup> and DR. E. ARNOLD<sup>3</sup> formed the nucleus around which the bulk of our commutation literature clung. MR. LAMME'S paper has the great merit of putting the more or less familiar problems of commutation in a new light. The end he attains is approximately the same as that attained by any other reasonably accurate method of analysis, provided all factors of importance are included, and the difficulties he encounters are of the same order and magnitude as those encountered by other investigators; but, by getting nearer to the true physical conditions in the zone of commutation, he saves us from drifting, sometimes aimlessly, on a sea of abstract speculation. Although the presentation of the subject as given in this chapter has undoubtedly been suggested by the reading of MR. LAMME'S paper, yet its aim is not so much to furnish additional material for the designer as to give the student a clear conception of the phenomena of commutation. The writer's end is simplicity or clearness, even if the less important factors

<sup>1</sup> B. G. LAMME: "A Theory of Commutation and Its Application to Interpole Machines," *Trans. A. I. E. E.*, vol. XXX, pp. 2359-2404.

<sup>2</sup> "Theoretical Elements of Electrical Engineering."

<sup>3</sup> "Die Gleichstrom-Maschine."

are entirely ignored, while, in MR. LAMME'S OWN words, his method of analysis, including as it does more conditions than are usually included, "instead of making the problem appear simpler than formerly . . . makes the problem appear more complex."<sup>1</sup>

In the first place, it may be stated that considerations of a mechanical nature, such as vibration, uneven or oily commutator surface, insufficient or excessive brush pressure, etc., cannot be dwelt upon here, and, in the second place, ideal or "straight-line" commutation will be assumed, and the conditions necessary to produce this—generally desirable—result investigated, in order that a multitude of more or less arbitrary assumptions may not obscure the problem in its early stages. By working from the simplest possible case to the more complex it is thought that the object in view—a physical conception of commutation phenomena leading to practical ends—will best be served, and influencing factors of relatively small practical importance will be either disregarded or but briefly referred to.

**45. Theory of Commutation.**—Consider a closed coil of wire of  $T_c$  turns moving in a magnetic field. At the instant of time  $t = 0$  the total flux of induction passing through the coil is  $+\Phi_0$  maxwells, and at the instant of time  $t = t_c$  sec. the total flux through the coil is  $+\Phi_t$  maxwells. Then on the assumption that the flux links equally with every turn in the coil, the average value of the e.m.f. developed in the coil during the interval of time  $t_c$  is

$$E_m = \frac{(\Phi_t - \Phi_0)T_c}{t_c \times 10^8} \text{volts.}$$

If  $R$  is the ohmic resistance of the coil and  $e$  is any instantaneous value of the e.m.f. produced by the cutting of the actual magnetic field in the neighborhood of the wire, the instantaneous value of the current in the coil is  $i = \frac{e}{R}$ , because  $e$  is the only e.m.f. in the circuit tending to produce flow of current. The usual conception of a distinct flux due to the current  $i$  producing a certain flux linkage known as the self-inductance of the circuit is avoided; but its equivalent has not been overlooked, seeing that the magnetomotive force due to the current in the coil is a factor in the production of the flux actually linked with this current at the instant of time considered. It is not suggested

<sup>1</sup> Reply to discussion, *Trans. A. I. E. E.*, vol. XXX, p. 2426 (1911).



that the orthodox method of introducing self-induction and mutual induction as separate entities endowed with certain properties peculiarly their own is not without advantages in the solution of many problems, especially when mathematical analysis is resorted to, but it tends to obscure the issue when seeking a clear understanding of the physical aspects of commutation. The splitting up of the magnetic induction resulting from different causes into several components is frequently convenient and should not be condemned except in certain cases when iron is present in the magnetic circuit. It cannot, however, be denied that self-induction and mutual induction are frequently thought of as different from other kinds of induction. We are indebted for this state of things to some writers whose familiarity with mathematical methods renders a clear physical conception of complicated phenomena unnecessary, but the practical engineer or designer who produces the best work, especially in departures from standard practice, is usually he who has the clearest vision of the physical facts involved in the problem under consideration. If the term self-induction calls up a mental picture of magnetic lines, being a certain component—expressed in maxwells—of the total or resultant flux of induction in a circuit, this does not prevent our speaking of flux linkage per ampere of current as inductance—expressed in henrys—and using the formula  $e = L \frac{di}{dt}$  to calculate that component of the total e.m.f. in a circuit which would have a real existence if the field due to the current  $i$  in the wire were alone to be considered.

Following the lead of MR. LAMME, the wires in the coil undergoing commutation will be thought of as cutting through a total flux of induction, expressed in magnetic lines or maxwells, this flux being the result of the magnetizing forces of field coils and armature windings combined.

In Fig. 54 the thick-line rectangle represents a full-pitch armature coil of  $T$  turns undergoing commutation. The dotted rectangles show the position of two consecutive field poles, and the shaded curve represents the ascertained or calculated flux distribution over the armature surface. The ordinates of this curve indicate at any point on the periphery the density of the flux entering the armature core. The direction of slope of the shading lines indicates whether the flux is positive or negative. A method that may be followed in predetermining

the flux distribution over the armature surface, including the interpolar space, was outlined in Chap. VII (refer to Art. 41, 42 and 43), and the flux-distribution curves of Fig. 54 might have been obtained in the same manner as the flux curve *C* referred to in Art. 43. The coil of Fig. 54 is supposed to be moving from left to right, and measurements on the horizontal axis *XX* may represent either distance travelled or lapse of time, since the armature is revolving at a uniform speed. The case considered is that of a dynamo without commutating poles, with brushes moved forward from the geometric neutral or no-load commutation position until a neutral commutating zone is again

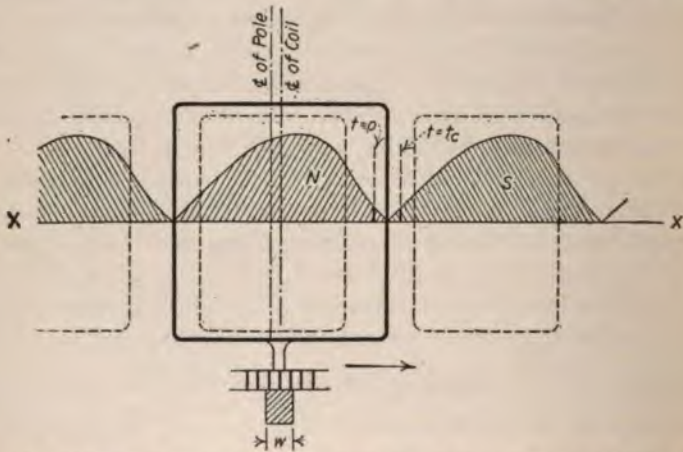

FIG. 54.—Diagram showing ideal armature coil in commutating zone.

found. The flux curves as drawn are the result of the combined m.m.fs. of field coils and armature windings. During the time of commutation,  $t_c$ , which, if we neglect the effect of mica thickness, is the time taken by a point on the commutator to pass under the brush of width  $W$ , the conductors on the right-hand side of the short-circuited coil have been moved through the neutral zone from a weak field of positive polarity into a weak field of negative polarity, while the conductors on the left-hand side of the coil have moved from a weak field of negative polarity into a weak field of positive polarity. Owing to the symmetry of the fields under the poles of opposite kind (*i.e.*, the similarity in shape and equality in magnitude of the shaded flux curves), and the fact that the small portions of the flux curves near the



neutral point may be considered as straight lines, the resultant flux cut by the two coil-sides—joined in series by the end connections—may be represented by the shaded area in Fig. 55, where positive values are measured above, and negative values below, the horizontal axis. Intervals of time are measured horizontally from left to right, and the straight line  $BB'$  represents the flux distribution in the commutating zone. The direction of this flux is such as to develop in the short-circuited coil, at every instant of time during the period of commutation, an e.m.f. tending to produce a current in the required direction; that is to say, from the commencement of short-circuit, when

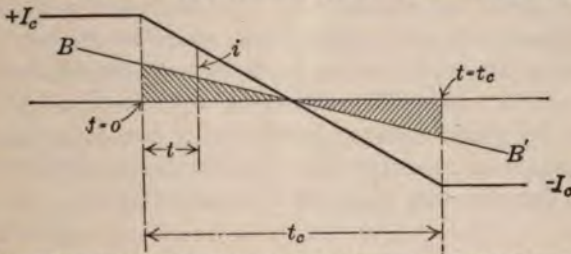

FIG. 55.—Flux distribution in commutating zone of ideal armature coil.

$t = 0$ , until the middle of the commutation period, when both flux and current are of zero value, the small amount of flux cut by the short-circuited conductors is of the same kind as that previously cut by the conductors, while from the time  $t = t_c/2$  until the end of commutation ( $t = t_c$ ) the flux is of the opposite kind, being such as will cause the current to flow in the opposite direction. The amount of the flux required to bring about this condition is only a small percentage<sup>1</sup> of the flux cut by a coil under the main poles in the same interval of time, because the resistance of the armature windings is always low in comparison with the resistance of the external circuit, and, as a matter of fact, it is the *average* value of the flux entering the armature over the commutating zone with which the designer is usually concerned. If the brushes are so placed as to bring the short-circuited conductors in a neutral field, satisfactory commutation will result.

<sup>1</sup> The flux density where the coil-side enters or leaves the commutating zone (the positions  $t = 0$  and  $t = t_c$  of Fig. 55) would be about 2.5 per cent. of the average density under the main poles, because this is the ratio of the armature  $IR$  drop to the developed voltage in a well-designed dynamo of moderate size—say, 50 to 100 kw.

Returning to a consideration of the case represented by Fig. 54, it must not be overlooked that the armature coil there shown is not of a practical shape, the end connections are shown parallel to the direction of travel of the coil, and the cutting of fluxes by these end portions of the coil has not been considered. When we consider the end fluxes, or the effect of commutating interpoles, especially when these are not equal in number to the main poles or do not extend the full length of the armature core, then the flux cut by the short-circuited conductors at any given part of their total length—such as the center of the “active” portion, whether on a smooth core or in slots—may have an appreciable value; but if we consider the *total* flux cut by *all* parts of the wire forming the commutated coil, when the current  $i$  in this coil is passing through zero value, it is most emphatically true that the coil as a whole is moving in a “neutral field,” *i.e.*, a resultant field which is either of zero value (when the sum of all its components is correctly taken) or of which the direction is parallel to the direction of travel of the conductors.

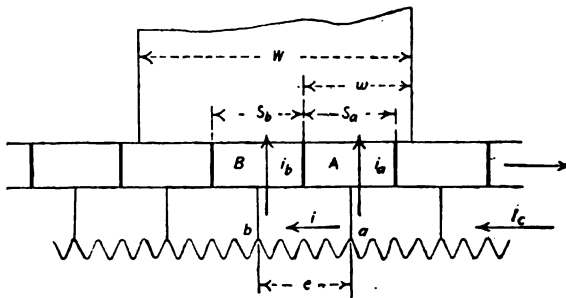

FIG. 56.—Diagram of coil and commutator during commutation.

At the beginning and end of the commutation period the field in which the coil moves should be such as to produce an e.m.f. in the short-circuited coil of the value  $e = I_c R$ , where  $I_c$  is the value of the current per path of the armature circuit and  $R$  is the resistance of the short-circuited coil. On the assumption of a uniform current density over the surface of the brush, the brush contact resistance need not be taken into account, as will be clear from the following considerations. Fig. 56 shows a brush of width  $W$  covering several segments of the commutator. The total current entering the brush is  $2I_c$ , and since the density

is constant over the surface of contact, the current entering the brush through any surface of width  $S$  is  $2I_c \times \frac{S}{W}$ . To calculate the volts  $e$  that must be developed in the coil of resistance  $R$  when the distance yet to be travelled before the end of commutation is  $w$ , consider the sum of the potential differences in the local circuit  $AabB$  which is closed through the material of the brush. This leads to the equation

$$e = iR + i_b R_b - i_a R_a \quad (67)$$

where  $R_a$  and  $R_b$  are contact resistances depending upon the areas of the surfaces through which the current enters the brush. Under the conditions shown in Fig. 56, the contact surfaces  $S_a$  and  $S_b$  are equal, and the currents  $i_a$  and  $i_b$  are therefore also equal. It follows that the voltage drops  $i_a R_a$  and  $i_b R_b$  are equal and cancel out from equation (67). The same is true in the later stages of commutation when  $S_a$  is no longer equal to  $S_b$  but to the portion  $w$  of the brush which remains in contact with the segment  $A$ . The relations between the currents and the surface resistances are then obtained by expressing these quantities in terms of the contact surface, thus:

$$\begin{aligned} i_a &= w \times k_1 \\ i_b &= S_b \times k_1 \\ R_a &= \frac{1}{w} \times k_2 \\ R_b &= \frac{1}{S_b} \times k_2 \end{aligned}$$

where  $k_1$  and  $k_2$  are constants, and the voltage drop  $i_a R_a$  is seen to be still equal to the drop  $i_b R_b$ . It follows that the only e.m.f. to be developed in the short-circuited coil when uniform current distribution is required will be  $e = iR$ .

The instantaneous value ( $i$ ) of the current in the coil undergoing commutation can be expressed in terms of the brush width  $W$  and the distance ( $w$ ) through which the coil still has to travel before completion of commutation, because,

$$\begin{aligned} i &= I_c - 2I_c \times \frac{w}{W} \\ &= I_c \left( \frac{W - 2w}{W} \right) \end{aligned}$$

and

$$e = I_c R \left( \frac{W - 2w}{W} \right) \quad (68)$$

At the beginning and end of commutation, when  $w$  is equal to  $W$  or to zero, the maximum value of the required voltage is  $e = I_c R$ .

In this study of the voltage to be developed in the coil undergoing commutation in order to produce a uniform current distribution over the brush surface, the resistance of the brush itself has been considered negligible; but with the assumption of a uniform current distribution over the cross-section of the brush the actual resistance of the brush material, even if it is relatively high, will not appear as a modifying factor in the general formula (68).

Referring again to Fig. 55, if the flux curve  $BB'$  may be considered a straight line, the current ( $i = \frac{e}{R}$ ) will also obey a straight-line law. It will fall from the value  $+I_c$  to zero in the time  $\frac{t_c}{2}$  and rise again to the value  $-I_c$  at the end of the period  $t_c$ , according to the simple law expressed by the straight line in Fig. 55. If the change of current actually occurs in this manner, we have what is called "straight-line" or ideal commutation. The commutation is then ideal or perfect, not only because it relieves the designer of much intricate and discouraging mathematical work, but because it is the only means by which the current density can be maintained constant over the brush surface of the usual rectangular form. It is generally the aim of the designer to maintain this current density as nearly constant as possible, because unequal current density leads to local variations of temperature and resistance in the carbon brush, and in those parts where the density attains very high values the excessive heating leads to pitting of the commutator surface even if visible sparking does not occur. Whatever method of studying commutation phenomena is followed, it is usual to assume some law connecting the variable current  $i$  with the time  $t$  and then investigate the causes which will bring about this condition. The straight-line law will therefore be assumed, but the thing of immediate moment—being in fact the whole problem of commutation in its broader aspect—is the location, or the creation, of a neutral zone where the actual resultant flux cut by the coil undergoing commutation will be zero.

Although the assumption of a smooth-core armature very greatly simplifies the problem, especially when an effort is made



to picture the actual distribution of the magnetic flux, it seems preferable to consider a machine with toothed armature because this is the case which has generally to be dealt with by the practical designer, and moreover it is exactly this question of teeth, or what is known as the slot flux, which sometimes leads to confusion of ideas, if not to inaccurate conclusions, and it should therefore not be disregarded in any modern theory of commutation.

**46. Effect of Slot Flux.**—In Fig. 57 an attempt has been made to represent, by the usual convention of magnetic lines, the flux due to the armature current alone, which enters or leaves the armature periphery in the interpolar space when the field magnets are unexcited. The position chosen for the brushes is the geometric neutral—*i.e.*, the point midway between two (symmetrical) poles—and the magnetic lines leaving the teeth will cross the air spaces between armature surface and field poles and so close the magnetic circuit. The brush is supposed to cover an angle equal to twice the slot pitch: the current in the conductor just entering the left-hand end of the brush is  $+I_c$ , the current in the conductor under the center of brush is zero, and the current in the conductor just leaving the brush on the right-hand side is  $-I_c$ . The armature is supposed to be rotating, and it will be seen that the conductors in which the current is being commutated are cutting the flux set up by the armature as a whole. It is important to note that the flux cut by a conductor while travelling between the two extreme positions during which the short-circuit obtains is not only the flux passing into the air gaps from the tops of the teeth included between these extreme positions of the conductor, but includes also the flux due to the currents in the short-circuited conductors, which crosses the slot above the conductor<sup>1</sup> and leaves the armature surface by teeth which are not included in what at first sight may seem to be the commutating zone. In other words, the portion of the armature flux cut by a conductor undergoing commutation when no reversing flux is provided from outside is that which passes up through the roots of the teeth included between the two extreme positions of the short-circuited coil. This picture of the conductor cutting the field set up by the armature

<sup>1</sup> For the sake of simplicity, a single conductor is shown at the bottom of each slot and the whole of the slot flux is supposed to link with it. The calculation of the "equivalent" slot flux will be taken up later.



currents is especially useful when calculations are made, as will frequently be found convenient, by considering the separate

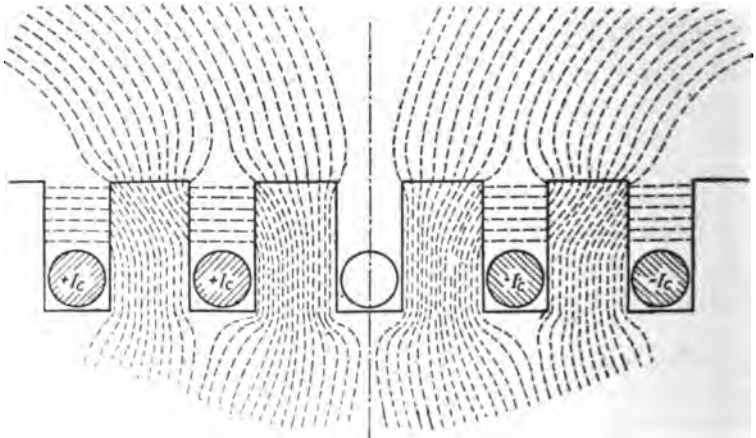

FIG. 57.—Flux in commutating zone due to armature m.m.f. only.

component fluxes due to distinct causes, all combining to produce the actual or resultant flux. It is not difficult to see that the flux shown in Fig. 57 is never such as to generate an e.m.f.

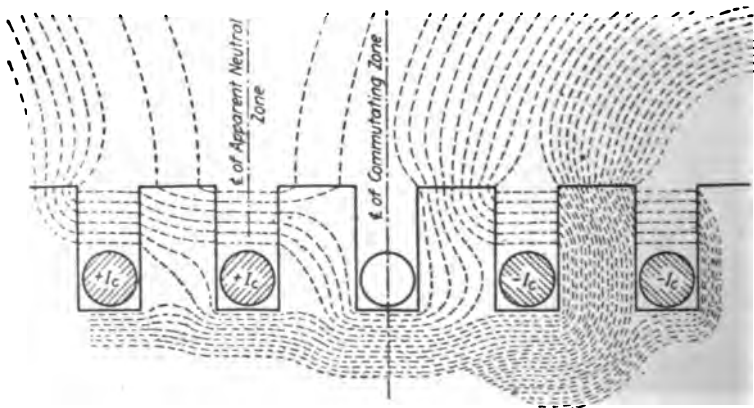

FIG. 58.—Flux in commutating zone near leading pole tip.

tending to reverse the current in the short-circuited conductor.

Consider now Fig. 58. The main poles have been excited and the brushes moved forward until a satisfactory commutating

zone has been found where the fringe of flux from the leading pole tip is sufficient to neutralize the flux due to the armature windings.<sup>1</sup> With the excitation of the leading main-pole tending to send flux through the armature core from right to left, and the armature e.m.f. tending to produce a flux distribution generally as indicated in Fig. 57, the resulting flux distribution in the commutating zone will be somewhat as shown in Fig. 58. Here the flux cut by the conductors during commutation is represented by eight lines only, the direction of this commutating flux being such as to maintain the current during the earlier stages of commutation and reverse it during the later stages. At a point midway between the two extreme positions the conductor is cutting no flux, and the current is therefore zero. It should be observed that the correct position for the brush is in advance of the "apparent" neutral zone; that is to say, the position of the neutral field on the surface of the armature does not correspond with the correct position for the center of the brush. That is because the slot flux must enter through the upper part of the teeth if it is not to be cut by the conductors during commutation.

Thus the conductor, which at the instant of time  $t = \frac{t_c}{2}$  must be in a neutral field, is actually below a point on the armature periphery where flux is entering or leaving the teeth, and this condition occurs even when, as in the present instance, the effect of the end connections is entirely negligible. This flux, which enters the teeth comprised between the two extreme positions of the short-circuited conductors, is neither more nor less than the slot flux (or equivalent slot flux, as the case may be). It is represented by 12 lines in the diagram Fig. 58, and it must be provided by the leading pole shoe if brush shift is resorted to, or by the commutating interpole when this method of cancelling the armature flux is adopted.

**47. Effect of End Flux.**—When the effect of the end connections of the armature coils cannot be neglected, the armature flux cut by this portion of the short-circuited coil must be cancelled in the same manner as the slot flux; that is to say, an

<sup>1</sup> Credit is given the reader for the ability to read in the expression "a flux neutralizing a flux" the more scientific but less convenient expression "the magnetic force due to one magnetizing source being of such magnitude and direction as to neutralize the magnetic force due to a second magnetizing source, thus causing the resultant flux of induction to be of zero value."

equal amount of flux, but of opposite sign, must enter the armature from the leading pole tip or interpole, and this component of the compensating flux will actually be cut by the conductors in the slot, thus neutralizing the e.m.f. developed by the cutting of the end fluxes. This will be made clearer by reference to Fig. 59, which is generally similar to Fig. 54, except that, instead of

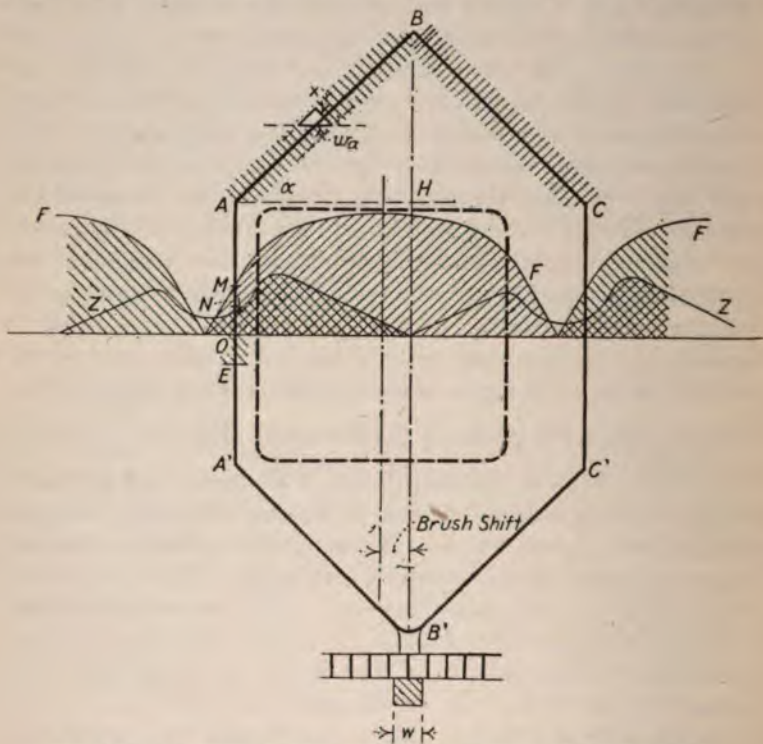

FIG. 59.—Diagram showing component fluxes cut by coil during commutation.

the actual interpolar flux, two distinct curves have been drawn, the one, *F*, representing flux distribution over armature periphery due to the field coils acting alone, and the other, *Z*, representing the flux distribution due to the armature windings acting alone. The addition of these two fluxes at every point will not always reproduce the actual flux curve of Fig. 54, because of possible saturation of portions of the iron circuit such as the armature teeth and pole tips; but, in the commutating zone, the method of adding the several imaginary components of the

actual flux is not objectionable, and the active conductors  $AA'$  in Fig. 59 may be considered as moving in a field of which the density is represented by the length  $MN$ , since the portion of the field flux represented by the distance between the point  $N$  and the datum line is neutralized by the armature flux at this point. Let  $ABC$  represent the position of the end connections of the coil undergoing commutation, then the portion  $AB$  is cutting end flux due to the armature currents in all the end connections, and the direction of this flux will be the same as that represented by the curve  $Z$ , all as indicated by the direction of the shading lines. The portion  $BC$  of the short-circuited coil will be cutting flux of the same nature as the armature flux cut by the slot conductors  $CC'$ , and the e.m.f. due to the cutting of the end fluxes will be of the same sign as that due to the cutting of the armature flux  $Z$ ; that is to say, it will tend to oppose the reversal of current and must therefore be compensated for by a greater brush lead or a stronger commutating pole. Similar arguments apply to the end connections  $A'B'C'$  at the other end of the armature. A means of calculating the probable value of the effective end flux will be considered later; but for the present it may be assumed that the average value of the density  $B_s$  of the field cut by the end connections is known. It may, therefore, be used for correcting the ordinate of the curve  $Z$  at the point  $O$ . Thus, the flux cut by the portion  $ABC$  of the end connections (see Fig. 59) in the time  $t_c$  is

$$\Phi_s = B_s \times x \times \text{length of } ABC$$

or

$$\Phi_s = B_s W_a \sin \alpha \times \text{length of } ABC$$

where  $\alpha$  is the angle between the lay of the end connections and the direction of travel, and  $W_a$  is the arc covered by the brush, expressed in centimeters of armature periphery. The equivalent flux density  $B_a$  which has to be cut by the slot conductors  $AA'$  to develop the same average voltage is obtained from the relation  $B_a W_a \times \text{length } AA' = B_s W_a \sin \alpha \times \text{length } ABC$

which gives

$$B_a = B_s \sin \alpha \times \frac{\text{length } ABC}{\text{length } AA'} \tag{69}$$

or, if preferred,

$$B_a = B_s \frac{2(BH)}{(AA')}$$



This may be plotted in Fig. 59 as the ordinate  $OE$ , making  $NE$  represent the armature flux, on the assumption that the whole of this flux component is cut by the "active" portion of the coil; and this suggests a graphical method of locating the correct brush position when commutating poles are not used, because what may be called the equivalent neutral zone is found when the conductor  $AA'$  occupies a position such that the length  $NE$  is exactly equal to  $OM$ . If this position cannot be found without passing under the tip of the pole shoe (represented by the heavy dotted rectangle), the machine will not commute perfectly without the addition of a commutating interpole.

The question of relative magnitude of these end flux e.m.f.s. deserves some attention, because it would be foolish to complicate the problem of commutation if the correction, when made, is of little practical moment. It is claimed by some writers that refinement of analysis and calculation is always commendable even when built upon a foundation that is admittedly a mere approximation. With this attitude of mind the present writer has no sympathy; it appears to lack the sense of proportion. Apart from any considerations of a mechanical nature, the practical problem of commutation, from whatever point of view it is approached, is, and always will be, the correct determination of the field in which the short-circuited coil is moving, whether this conception of the magnetic condition is buried in the symbols  $L$  and  $M$ , and referred to as inductance, expressed in henrys, or considered merely as any other magnetic field; and it would surely be a waste of time and mental effort to introduce refinements if the percentage correction, when made, is of a small order of magnitude. The question of end fluxes, however, is one of real practical importance; the end flux in actual machines is not of negligible amount, and although it cannot be calculated exactly, it is a factor which should not be left out of consideration. It is true that we do not concern ourselves with the end fluxes when calculating the useful voltage developed in the active coils; but, apart from the fact that in this connection the amount of the end flux is relatively small, it is not difficult to see that the e.m.f.s generated in the end connections as they cut through the end fluxes due to the armature currents balance or counteract each other and have no effect on the terminal voltage. The conception of the end connections cutting through the flux due to the armature as a whole, as indicated in Fig. 59,



seems more natural, and is more helpful to the understanding of commutation phenomena, than what might be termed the academic method, in which more or less reasonable assumptions are made in respect to self- and mutual inductances; but it is not suggested that the one method is necessarily superior to the other so far as practical results are concerned.<sup>1</sup> While moving from the position at the commencement of the commutation where the current is  $+I_c$  to the position at the end of commutation where the current is  $-I_c$ , the short-circuited coil has cut through the flux of self- and mutual induction—through the whole of it, not merely through certain components of the total flux in the particular region considered. This is well expressed by MR. MENGES when he says<sup>2</sup>: “. . . Self-induction is in no way distinguishable from other coexistent electromagnetic induction. Therefore, when the real magnetic flux resulting from all causes, and its changes relative to a given circuit, are taken into account, the self-induction is already included, and it would be erroneous to add an e.m.f. of self-induction.”

**48. Calculation of End Flux.**—With a view to calculating within a reasonable degree of accuracy the flux density in the zone *ABC* of Fig. 59, it is necessary to make certain assumptions and to use judgment in applying the calculated results, because it is not possible to determine this value with scientific accuracy even when the exact shape of the armature coils and the configuration of the surrounding masses of iron are known.

In the first place, the angle  $\alpha$  of Fig. 59, will be taken as 45 degrees, which, although perhaps slightly greater than the average on modern multipolar machines, has the advantage that it permits us to treat the wires *AB* and *BC* as being at right angles to each other. The further assumption will be made that the armature is of large diameter, and the developed view of the end connections, as shown in Fig. 60, can therefore be considered as lying in the plane of the paper. The flux in the zone occupied by the portion *AB* of the coil undergoing commu-

<sup>1</sup> As a matter of fact, a careful study of the problem will show that the total armature flux cut by one commutating coil during the period of short-circuit—being the difference between the number of lines threading the coil immediately before and immediately after commutation—is almost entirely due to the changes of current that have taken place in the coils under the brushes during the period of commutation.

<sup>2</sup> C. L. R. E. MENGES in the London *Electrician*, Feb. 28, 1913.

tation is due to the currents in all the neighboring parallel conductors comprised in the parallelogram  $ADBC$ . The direction of flow of current in these parallel conductors is indicated by the arrows, being outward (*i.e.*, from  $A$  to  $B$ ) on the left-hand side of the commutating zone, and inward (from  $B$  to  $A$ ) on the right-hand side. The intensity of the field produced on  $AB$  by any one of these wires, if the lines of force are assumed to be circles in a path consisting entirely of air (the proximity of masses of iron being for the present ignored), will be inversely proportional

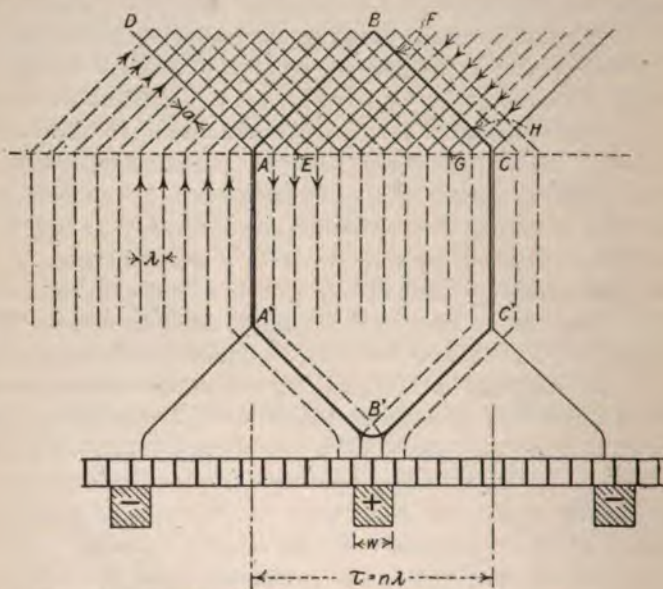

FIG. 60.—Developed view of armature end connections.

to the distance of the wire considered; and the extent to which this wire will be effective in producing a field along  $AB$  will depend upon its length. Thus, a conductor such as  $EF$  will produce not only a stronger component of the resulting field in the commutating zone than the wire  $GH$ , but a field of which the extent is measured by the length  $EF$ , while the more distant wire will produce a weaker field over a length equal to  $GH$  only. Thus the effect of the more distant wires in building up the flux over the commutating zone decreases very rapidly with increase of distance. Fig. 61 represents a section perpendicular to the conductor  $AB$  of Fig. 60. It is assumed that the brush covers

two bars (a reasonable, but not a necessary, assumption),<sup>1</sup> and the condition shown in Fig. 61, corresponds to the middle of the commutation period, with zero current in the short-circuited coil and full armature currents of  $+I_c$  and  $-I_c$  respectively in the neighboring conductors.

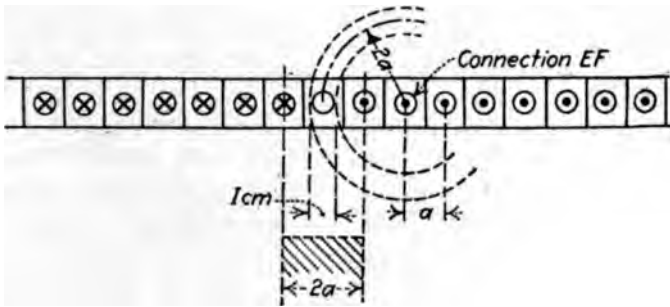

FIG. 61.—Magnetic flux due to end connections.

Considering the full-pitch coil of pitch  $\tau$  centimeters measured over the armature surface, we can write

$$\tau = n\lambda$$

where  $n$  = number of slots per pole, and  $\lambda$  = slot pitch in centimeters. Then the length  $AB$  (Fig. 60), which is approximately one-quarter of the total length of "inactive" copper per coil, is

$$l = \frac{\tau}{\sqrt{2}} = \frac{n\lambda}{\sqrt{2}}$$

and the pitch of the end windings (which are supposed to lie in the same plane as the conductors in the slots) will be,

$$a = \frac{\lambda}{\sqrt{2}} = \frac{l}{n}$$

Let  $T$  = number of conductors or turns per coil (which is not necessarily the same as the number of turns between commutator bars, because there may be more commutator bars than there are slots on the armature), and let  $I_c$  = the amperes of

<sup>1</sup> Within practical limits, the width of the brush does not appreciably affect the average density of the armature flux cut by the commutated coil. A wide brush, by short-circuiting several coils, reduces the number of conductors carrying the full armature current, and to this small extent the total m.m.f. producing the flux in the commutating zone is less with a wide brush than with a narrow brush.

current per conductor; then, since the field intensity at a distance  $y$  cm. from a straight conductor is

$$H = \frac{0.2 \times \text{current in amperes}}{y}$$

we may write, for field intensity due to the group of conductors  $EF$ ,

$$H_{ef} = \frac{0.2 \times TI_c}{2a}$$

The flux produced in the zone  $AB$  by the same group of wires ( $EF$ ) will be proportional to the value of  $H$  multiplied by the length  $EF$ . Thus, in a zone 1 cm. wide, of which the center line is  $AB$ , the flux of induction due to the conductor  $EF$  is

$$\Phi_{ef} = \frac{0.2TI_c}{2a} (l - 2a)$$

The sum of all such elements of the total flux, taken for all the parallel conductors on both sides of  $AB$  will be

$$\Phi = \frac{0.4TI_c}{a} \left[ l - a + \frac{l - 2a}{2} + \frac{l - 3a}{3} \dots + \frac{l - na}{n} \right]$$

which, bearing in mind the relation  $l = an$ , simplifies into

$$\Phi = 0.4TI_c n \left( \frac{1}{2} + \frac{1}{3} + \frac{1}{4} \dots + \frac{1}{n} \right) \quad (70)$$

The total flux (maxwells) cut by the end connections  $ABC$ , being one-half of the length of "inactive" copper in the commutated coil, is given by the expression

$$\begin{aligned} \Phi_s &= 2\Phi \times W_a \sin \alpha \\ &= \sqrt{2}\Phi \times W_a \\ &= 0.4\sqrt{2}TI_c n W_a \left( \frac{1}{2} + \frac{1}{3} + \frac{1}{4} \dots + \frac{1}{n} \right) \end{aligned} \quad (71)$$

in which  $W_a$  is, as before, the brush arc expressed in centimeters of armature periphery.

The value of the series in the brackets is readily computed with the aid of a table of reciprocals, but if preferred this series can be put in the form  $(\log_e 2n) - 1$ , which is really more accurate, since it assumes a current uniformly distributed through the copper section of the conductors instead of being concentrated at the center of each coil as assumed in deriving formula (70).

The assumption has been made that the paths of the flux lines are air paths only; but on account of the proximity of the pole shoes to the points where the end connections leave the slots, and also because the conductors actually remain parallel to the shaft for a short distance beyond the core, the value of  $\Phi_e$  would be larger than as given by formula (71). A constant should therefore be included, and if the convergent series is replaced by the logarithmic function, the formula becomes,

$$\Phi_e = 0.4\sqrt{2}kTI_c n W_e [(\log_e 2n) - 1] \quad (72)$$

The average flux density over the zone considered is

$$B_e = \frac{0.4\sqrt{2}kTI_c}{\lambda} [(\log_e 2n) - 1] \quad (73)$$

If the end coils lie on a cylindrical support of iron or steel, the reluctance of the flux paths is very nearly halved, and the value of  $k$  in formulas (72 and (73) should therefore be doubled. If it is desired to consider the increased flux due to the use of steel binding wires or bands, this can be done by making a suitable correction to the factor  $k$ .<sup>1</sup>

Should it be desired to calculate separately the average value of the total e.m.f. generated in the end connections of the short-circuited coil, we have

$$E_e = \frac{B_e l_e VT}{10^8}$$

where  $l_e$  = total length of coil outside armature slots (both ends) in centimeters,

$$= 2\sqrt{2}\lambda n, \text{ if we keep to the assumption of angle } \alpha = 45 \text{ degrees,}$$

and  $V$  = speed of cutting, in centimeters per second,

$$= \frac{\pi DN_e}{\sqrt{2}}, \text{ in which } D \text{ is the armature diameter in}$$

centimeters, and  $N_e$  is the speed in revolutions per second. The factor  $\sqrt{2}$  is the necessary correction to give the component of the velocity at right angles to the conductor. Inserting the value of  $B_e$  given by formula (73), and making the required simplifications, the formula for voltage becomes

$$E_e = \frac{k \times 0.8\sqrt{2} n I_c T^2 (\pi DN_e) (\log_e 2n - 1)}{10^8} \quad (74)$$

<sup>1</sup> This is discussed by MR. LAMME in his Institution paper previously referred to.



The numerical value of  $k$  in multipolar machines of modern design will usually lie between 1.3 and 3.5, the high value being taken when the end connections lie on a steel or iron supporting cylinder against which they are held by bands of steel wire.

For first approximations the formula may be put into simpler form.

Let  $A_c$  stand for the ampere-conductors per pole pitch of armature periphery ( $A_c = 2TnI_c$ ). Let  $k = 2.4$  (being an average value), and for the quantity  $(\log_e 2n - 1)$  put the numerical value 2.2 (the assumption here being that there are 12 to 14 slots per pole), then

$$E_s \text{ (approximately)} = \frac{3TA_cV}{10^8} \quad (75)$$

where  $V$  is, as before, the peripheral velocity of the armature in centimeters per second.

The above calculations and conclusions are based on the assumption of a full-pitch winding. With a chorded or short-pitch winding, the average flux density in the commutating zone will be slightly reduced; and there will be a further gain due to the shortening of the end connections ( $ABC$  and  $A'B'C'$  in Fig. 59). Thus the voltage generated by the cutting of the end fluxes, with a short pitch winding, will be slightly less than the value calculated by formula (74), or by the approximate formula (75), which applies to a full-pitch winding.

**49. Calculation of "Slot Flux" Cut by Coil during Commutation.**—A reference to the diagrams of flux distribution in the commutating zone (Figs. 57 and 58) will make clear the fact that, even when the effect of the end connections is neglected, the center of the neutral commutating zone is not the point on the armature periphery where flux neither enters nor leaves the teeth; because in order that the short-circuited conductors shall not cut the slot leakage flux, this flux must be provided by the main field pole toward which the brushes are shifted to obtain perfect commutation. The point on the armature periphery where flux neither enters nor leaves the teeth may be found by drawing curves representing the magnetomotive forces exerted by field poles and armature windings at every point on the armature periphery, and where the sum of the ordinates of such curves is zero the surface flux density must also be zero. The brushes must, however, be moved forward beyond this point until the reversing flux entering the teeth comprised in the brush arc has

the value  $\Phi_s$  as given by the formula (72), to compensate for the end fluxes, plus the total slot flux  $\Phi_s$ , which is twice the leakage from tooth to tooth in one slot when the conductors are carrying the full armature current.<sup>1</sup> In practice, when we wish to calculate the volts generated in the coil of  $T$  turns by this slot leakage flux, it is the *equivalent* slot flux that must be considered, because the total number of lines crossing between the sides of adjacent teeth does not link with all the wires in the coil.

It will be convenient to assume the same number of slots as there are commutator bars, and the whole of the slot space to be filled with  $2T$  conductors, each carrying a current of  $I_c$  amp. (this follows from the assumption of a full-pitch winding). Thus no account will be taken of the fact that a small space occurs between upper and lower coils, where the slot flux will not pass through the material of the conductors. The lines of the slot flux will be supposed to take the shortest path from tooth to tooth; the small amount of flux that may follow a curved path from corner to corner of tooth at the top of the slot will be neglected. Refinements of this nature may be introduced, if desired, when solving the problem for a concrete case.<sup>2</sup> If the usual assumption is made that the reluctance of the iron in the path of the magnetic lines is negligible in comparison with the slot reluctance, the small portion of slot flux in the space  $dx$  (Fig. 62) considered 1 cm. long axially (*i.e.*, in a direction perpendicular to the plane of the paper) is

$$d\Phi = \text{m.m.f.} \times dP$$

where  $dP$  is the permeance of the air path. Thus,

$$d\Phi = 0.4\pi (2TI_c) \frac{x}{d} \times \frac{dx}{s}$$

<sup>1</sup> In the case of short-pitch windings, or when there are more commutator bars than there are slots on the armature, the amount of the slot flux must be calculated for the instant when the coil enters or leaves the commutating zone. This flux will depend not only upon the dimensions of the slot but also upon the current carried by each conductor and the position of the latter in the slot.

<sup>2</sup> With short-pitch windings, or when there are several coils per slot, all the conductors in the slot may not be carrying the full armature current when the coil enters or leaves the commutating zone. In such cases the actual conditions must be studied, an average value for the slot flux being readily arrived at. If necessary, the straight-line law of commutation may be assumed in order to estimate the current values in the coils passing through the intermediate stages of commutation.

but this flux links with only  $2T \times \frac{x}{d}$  conductors, and the equivalent slot flux, which would generate the same e.m.f. if cut by all the conductors in the slot, is therefore

$$d\Phi_{(equivalent)} = d\Phi \times \frac{x}{d}$$

and

$$\begin{aligned} \Phi_{(equivalent)} &= \frac{0.8\pi TI_c}{d^2 s} \int_0^d x^2 dx \\ &= \frac{0.8\pi d}{3s} TI_c \end{aligned} \tag{76}$$

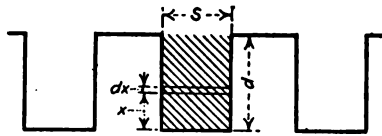

FIG. 62.—Illustrating slot-flux calculations.

This is the equivalent flux in maxwells per centimeter of axial length of armature slot. If  $l_a$  = axial length of armature core expressed in centimeters,<sup>1</sup> the total slot flux cut by each coil-side during commutation, being twice the flux per slot, as shown in Fig. 57, is

$$\Phi_{ss} = \frac{1.6\pi d}{3s} TI_c l_a \tag{77}$$

The voltage component due to the cutting by both coil-sides<sup>2</sup> of the slot flux considered separately from other fluxes would be

$$E_s = \frac{2\Phi_{ss} T}{10^8 t_c}$$

where the time of commutation

$$\begin{aligned} t_c &= \frac{\text{brush arc in centimeters of armature periphery}}{\text{peripheral velocity in centimeters per second}} \\ &= \frac{W_a}{V} \end{aligned}$$

Thus,

$$E_s = \frac{3.2\pi T^2 I_c d l_a V}{3 \times 10^8 s W_a} \tag{78}$$

The factor  $W_a$  in the denominator of this formula indicates that the slot flux is of less importance with a wide than with a narrow

<sup>1</sup> It is well to let  $l_a$  stand for the gross length of armature core, although in slot flux calculations the total width of vent ducts is sometimes deducted.

<sup>2</sup> The  $2T$  conductors in the one slot are here considered as equivalent to the two coil-sides, each of  $T$  wires, in separate slots one pole pitch apart.

brush. This is generally true, although it must be remembered that the formula (78), in common with other formulas previously derived, is not of general application. Within the limits of this chapter, it is not possible to consider all special cases; and commutation formulas of general applicability cannot be developed. When there is more than one coil per slot, and when there are "dead coils," inequalities occur which complicate the problem and make it impossible to obtain ideal commutation with every coil on the armature. In such cases the slot flux must be calculated for the coils that are differently situated in regard to the brush position and an average value selected for use in the calculations.

Knowing the slot flux  $\Phi_{es}$  and the previously calculated end flux  $\Phi_e$  cut by the conductors of the short-circuited coil while traveling over the distance  $W_a$ , the correct brush position is found when the reversing flux entering the teeth comprised in the commutating zone of width  $W_a$ , is approximately  $\Phi_{es} + \Phi_e$  maxwells. The flux actually cut by the one coil-side is, however, only  $\Phi_e$ ; the component  $\Phi_{es}$  of the total flux entering the commutating zone merely supplies the leakage from tooth to tooth across the slot. The presence of the slot flux undoubtedly tends to complicate the problem of commutation. It should be noted that the slot flux  $\Phi_{es}$ , if calculated by formula (77), is what has been referred to as the equivalent slot flux; that is to say, a flux of this value, if cut by an imaginary concentrated winding of  $T$  turns, would develop the same voltage in the coil as the actual slot flux develops in the actual winding. The condition of importance to be fulfilled is simply that the "equivalent" flux cut by the coil-side in the reversing field shall have the value  $\Phi_e$ . The flux cut by the coil-side may be separated into two parts: (1) the flux passing through the teeth into the armature, which links with *all* the conductors in the slot, and (2) the equivalent slot flux. It is important to note that although the total or actual slot flux is the same whether it enters the top or the root of the tooth, the flux linkage and therefore the developed voltage have not the same value in the two cases. The total slot flux, on the basis of the assumptions previously made, is

$$\begin{aligned} \Phi_s &= \frac{2 \times 0.4\pi (2TI_c)l_a}{ds} \int_0^d xdx \\ &= \frac{0.8\pi dTI_c l_a}{s} \end{aligned} \tag{79}$$

being one and one-half times the equivalent slot flux given by formula (77). The equivalent flux when the total slot flux enters the tooth top instead of passing through root of tooth is no longer expressed by formula (77); it may be calculated thus:

The magnetic lines represented by the expression  $d\Phi = 0.4\pi (2TI_c) \frac{x}{d} \frac{dx}{s}$  no longer link with  $2T \frac{x}{d}$  conductors, but with  $2T \frac{(d-x)}{d}$  conductors (see Fig. 62). The equivalent flux, when no part of this flux passes into the armature core below the teeth, is therefore

$$\begin{aligned} \Phi'_{es} &= 2l_a \int_0^d d\Phi \times \frac{d-x}{d} \\ &= \frac{1.6\pi TI_c l_a}{d^2 s} \int_0^d x(d-x) dx \\ &= \frac{1.6\pi d}{6s} TI_c l_a \end{aligned} \tag{80}$$

or just half the equivalent slot flux as given by formula (77). The question now arises: What is the necessary total flux entering the tops of the teeth comprised in the commutating zone to develop the proper voltage component in the short-circuited coil?

A total slot flux as given by formula (79) has the "equivalent" value as given by formula (80); that is to say, it is—on the basis of the assumptions previously made—three times as great as the equivalent flux. The total flux entering the teeth comprised in the commutating zone should therefore be

$$\begin{aligned} \Phi_c &= 3\Phi'_{es} + \text{flux passing directly into armature core through} \\ &\quad \text{the teeth.} \\ &= 3\Phi'_{es} + \Phi_d \end{aligned}$$

but  $\Phi'_{es} + \Phi_d = \Phi_e$ , where  $\Phi_e$  is, in this particular instance, the equivalent value of the total flux to be cut by the "active" portion of the short-circuited conductors.

Thus

$$\Phi_c = 2\Phi'_{es} + \Phi_e \tag{81}$$

or, if preferred,

$$\Phi_c = \Phi_{es} + \Phi_e \tag{82}$$

where  $\Phi_{es}$  is the equivalent slot flux as originally calculated and expressed by formula (77).



The flux actually entering the armature teeth in the commutation zone should therefore be equal to the sum of the end flux  $\Phi_e$  and the equivalent slot flux  $\Phi_{es}$ . It is because this conclusion is not obvious that it has been deduced from the foregoing arguments.

Having determined the value of the flux  $\Phi_e$  which must enter the teeth comprised in the commutating zone of width  $W_a$ , it is evident that the average air-gap density in this zone, to produce perfect commutation, must be

$$B_c = \frac{\Phi_e}{W_a \times l_a} \quad (83)$$

By referring to the final flux distribution curve,  $C$ , obtained by the method outlined in Art. 43, Chap. VII, it may easily be seen whether or not the desired field can be obtained in the fringe of the leading pole tip. If the required field is greater than that obtainable in the interpolar space, commutating poles must be provided, or the machine must be re-designed. If the flux-distribution curves have not been drawn, the calculated density  $B_c$  required in the commutating zone, as expressed by formula (83), may be compared with the average air-gap density under the main poles. If the required density does not exceed one-half of the average density of the main flux taken over the pole pitch, it will usually be possible to obtain satisfactory commutation in the fringe of the leading pole tip, provided carbon brushes are used. In the event of  $B_c$  being in excess of this value, interpoles will probably be necessary.

**50. Commutating Interpoles.**—Assuming the same number of interpoles as there are main poles, and an axial length of interpole equal to that of the main pole, the flux from each interpole which enters the armature teeth included in the commutating zone of width  $W_a$  is, as before,  $\Phi_{es} + \Phi_e$ .

If, as is usually the case, the interpole face does not cover the whole length of the armature core, then some flux due to the total m.m.f. of the armature windings will enter or leave the armature core by the teeth included in the commutating zone, and this flux will be cut by that portion of the slot conductors which is not covered by the interpole. With the brushes on the geometric neutral line, this armature flux is unaffected by the excitation of the main poles; its value depends only upon the armature ampere-turns and the reluctance of the air paths

between the armature surface and neighboring masses of iron. It can be predetermined within reasonably close limits by plotting the full-load flux curve,  $C$ , as indicated in Art. 43, Chap. VII. The flux entering and leaving the surface of the armature in the commutating zone, when the axial length  $l_p$  of the interpole is appreciably less than the gross length  $l_a$  of the armature core is indicated in Fig. 63. Before calculating the flux which must enter the armature teeth from the commutating pole, it will be advisable to define clearly the various flux components to be considered.

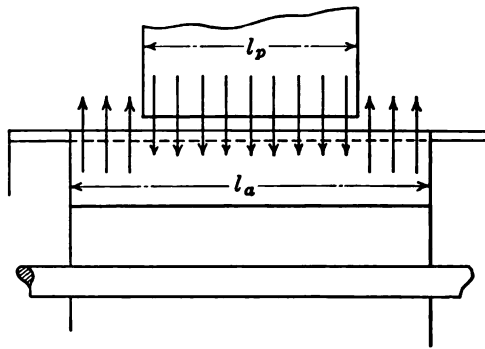

FIG. 63.—Commutating pole: showing direction of flux at armature surface

Many of the symbols used in the previous calculations will be employed, but it is proposed to alter the meaning of some of these because it will be more convenient to think of the slot flux per centimeter length of slot instead of the flux over the whole length of slot as in the previously developed formulas. This slight change will probably lead to less confusion than if a complete new set of symbols were to be introduced here.

- $\Phi_c$  = total flux entering armature teeth from interpole, over area of width  $W_a$  and length  $l_p$ .
- $\Phi_e$  = total end flux (one end of armature).
- $\Phi_s$  = total slot flux per centimeter of armature length (two slots).
- $\Phi_{s,}$  = equivalent slot flux per centimeter, if magnetic lines pass outward from armature core through root of teeth (two slots).
- $\Phi'_{s,}$  = equivalent slot flux per centimeter, if magnetic lines pass inward from air gap through top of teeth (two slots).

$\Phi_d$  = portion of interpole flux per centimeter length, which enters armature core through root of teeth.

$\Phi_a$  = armature flux per centimeter length, which leaves teeth over the commutating zone of width  $W_c$  and length  $l_a - l_p$  (Fig. 63).

The equivalent flux to be cut by conductors under the interpole must equal the total of all the flux components that have to be neutralized. This leads to the equation

$$\Phi_d l_p + \Phi'_{aa} l_p = \Phi_e + \Phi_a(l_a - l_p) + \Phi_{aa}(l_a - l_p)$$

from which a value for  $\Phi_d$  can be calculated. The total flux leaving interpole is

$$\Phi_c = \Phi_e l_p + \Phi_d l_p$$

Inserting for  $\Phi_d$  in this last equation the value derived from the previous equation, we get

$$\Phi_c = \Phi_e l_p + \Phi_e + \Phi_a(l_a - l_p) + \Phi_{aa}(l_a - l_p) - \Phi'_{aa} l_p \quad (84)$$

This equation may be simplified by expressing to total slot flux  $\Phi_s$  and the equivalent slot flux  $\Phi'_{aa}$  in terms of the equivalent slot flux  $\Phi_{aa}$ . The relation between these quantities is obtained by comparing the previously developed equations (79), (80) and (77). Thus,

$$\Phi_s = \frac{3}{2} \Phi_{aa}$$

and

$$\Phi'_{aa} = \frac{1}{2} \Phi_{aa}$$

Inserting these values in equation (84) we get

$$\Phi_c = \Phi_e + \Phi_{aa} l_a + \Phi_a(l_a - l_p) \quad (85)$$

wherein the symbols  $\Phi_{aa}$  and  $\Phi_a$  stand for flux components *per unit length* of armature core, as previously mentioned.

Knowing the amount of the flux to be provided by each interpole, its cross-section can be decided upon and the necessary exciting ampere-turns calculated, bearing in mind the following requirements:

(a) The average air-gap density should be low (about 6,000 gaussas corresponding to full-load current), to allow of increase on overloads.

(b) The leakage factor should be as small as possible. This involves keeping the width and axial length of interpole small,

thus conflicting with condition (a) and presenting one of the difficulties of commutating-pole design.

(c) the minimum width of pole face must be such that the equivalent pole arc (which must include an allowance for fringing) shall cover the commutating zone of width  $W_a$ .

(d) The equivalent pole arc should, if possible, be an exact multiple of the slot pitch (either once or twice the slot pitch) as this tends to reduce the magnitude of the flux pulsations in the interpole. The effects of these flux pulsations, caused by variations in the reluctance of the interpole air gap, are, however, usually of no great practical importance, but the width of brush should not be determined independently of the interpole design.

(e) In order to keep down the  $I^2R$  losses in the series turns on the interpole (usually amounting to less than 1 per cent. of the total output), the ampere-turns and the length per turn should be as small as possible. The gain resulting from a small air gap is, however, not great, because the ampere-turns required to overcome the air-gap reluctance rarely exceed 25 per cent. of the total, the balance being required to oppose the armature m.m.f. A reasonably large air gap has the advantage of reducing the flux pulsations referred to under (d).

(f) The effect of the interpole being to increase the flux in that portion of the yoke which lies between the interpole and the main pole of opposite polarity, it is important to see that the resulting flux density in this part of the magnetic circuit is not excessive. A similar condition exists in the armature core, but this does not usually determine the limits of the allowable average flux density below the teeth.

(g) Series- or wave-wound armatures are to be preferred on machines with commutating poles, especially when the air gap under the main poles is made smaller than it would have to be if interpoles were not used.

(h) The total line current should, if possible, pass through all the interpole windings in series; that is to say, parallel circuits should be avoided because of the possibility that the current may not be equally divided. If the total current is too great, a portion may be shunted through a diverter.<sup>1</sup> The diverter should be partly inductive, the resistance being wound

<sup>1</sup> The use of a resistance as a shunt to the series field winding—usually known as a diverter—will be referred to again later when considering the design of the field magnets.

on an iron core in order that the time constants of the main and shunt circuits may be approximately equal. If this is not done, the interpole winding will not take its proper share of the total current when the change of load is sudden, and this may lead to momentary destructive sparking.

Among the advantages of commutating poles may be mentioned the fixed position of the brushes and the fact that fairly heavy overloads can be taken from the machine without destructive sparking, because of the building up of the commutating flux with increase of load. The limiting factor in this connection is the saturation of the iron (mainly of the interpole itself) in the local circuit, and this is aggravated by the large percentage of leakage flux due to the proximity of main and commutating poles. Deeper armature slots may be used than in the case of machines without interpoles, and the specific loading (ampere-conductors per unit length of armature periphery) may be increased, thus allowing of greater output notwithstanding the slight reduction in width of main poles necessary to accommodate the interpoles. The maximum output of the machine with commutating poles is usually determined by the heating limits, the ventilation being less effective than in the case of non-interpole machines. The  $I^2R$  loss in interpole windings is to some extent compensated for by a reduction of the ampere-turns on the main poles when shorter air gaps are used. With the brushes on the geometric neutral and an air gap which is small relatively to the space between pole tips, field distortion *per se* has nothing to do with commutation, whether interpoles are used or not; if the fringe from the leading pole tip is not to be used for counteracting the effects of end flux and slot flux on the coil undergoing commutation, the unequal flux distribution under the main poles due to cross-magnetization does not affect the field at a point midway between two main poles. It is not suggested that field distortion is unobjectionable when the brushes are on the geometric neutral or when interpoles are used. The concentration of flux at one side of the main pole may lead to flashing over the commutator surface (an effect often attributed to unsatisfactory commutation, though rarely due to this cause); but the chief objection to a large number of armature ampere-turns per pole is the fact that the flux in the zone of commutation due to this m.m.f. must be compensated for somehow if satisfactory commutation is to be obtained. It



is exactly in the zone corresponding to the brush position that the armature m.m.f. has its maximum value. In the case of the interpole machine, the windings necessary to compensate for armature cross-magnetization are an objectionable feature, and, except for the added cost and tendency to interfere with ventilation, there is much to be said in favor of pole-face windings, the function of which is to neutralize the magnetizing effect of the armature winding and maintain an approximately constant flux density over the pole faces. The writer has in mind machines such as those which, for the last 20 years, have been constructed under the THOMPSON-RYAN patents. One

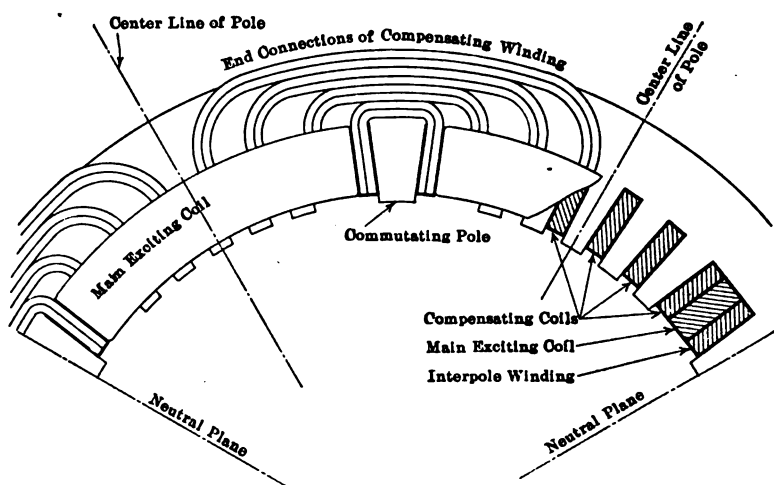

FIG. 64.—Compensating pole-face winding.

of the attractive features of such designs is the fact that the winding on the commutating poles need be no greater than that required to overcome the reluctance of the air gap and send the requisite flux into the armature teeth comprised in the commutating zone. A pole-face compensating winding is shown in Fig. 64. The balancing coils pass through slots in the pole face and carry the full current of the machine; that is to say, they are connected in series with the commutating-pole windings and the compounding series turns (if any) on the main poles. The connections between the pole-face compensating coils are so made that the current in these will always tend to neutralize the magnetic effect of the currents in the armature coils, and so prevent distortion of the flux over the pole face.

**51. Example of Interpole Design.**—The numbers and dimensions used to illustrate the method of calculation outlined above will be chosen without reference to an actual design of interpole dynamo, and they must not be considered representative of modern practice. Assume the leading particulars of the machine to be as follows:

Output = 200 kw.

Volts = 440.

R.p.m. = 500.

Number of main poles  $p = 6$ .

Armature core diameter  $D = 30$  in.

Armature core length  $l_a = 11$  in. = 28 cm.

Total number of slots = 120.

Number of slots per pole  $n = 20$ .

Slot pitch  $\lambda = 0.785$  in.

Slot width  $s = 0.39$  in.

Slot depth  $d = 1.5$  in.

Style of winding: full-pitch, multiple.

Current per armature path  $I_a = 76$  amp.

Number of conductors per slot = 8.

Total number of conductors  $Z = 120 \times 8 = 960$ .

Number of commutator bars = 240. (There are four coil-sides per slot, or two coils, giving two turns between adjacent commutator bars.)

Diameter of commutator = 20 in.

Pitch of commutator bars =  $\frac{\pi \times 20}{240} = 0.262$  in.

Number of bars covered by brush = 3.5.

Thickness of brush (brush arc)  $W = 0.262 \times 3.5 = 0.916$  in.

Brush arc referred to armature periphery

$$W_a = \frac{0.916 \times 30}{20} = 1.375 \text{ in.} = 3.5 \text{ cm.}$$

Assuming the same number of commutating poles as there are main poles, the flux entering the armature teeth in the commutating zone of width  $W_a$  should have the value given by formula (85). The end flux cut by the short-circuited coils is given approximately by formula (72) in which the coefficient  $k$  may be given the value 2. Thus:

$$\begin{aligned} \Phi_e &= 0.4\sqrt{2}kTI_a n W_a [(\log_e 2n) - 1] \\ &= 0.4\sqrt{2} \times 2 \times 4 \times 76 \times 20 \times 3.5 \times (3.69 - 1) \\ &= 64,800 \text{ maxwells.} \end{aligned}$$

In regard to the slot flux, at the beginning or end of commutation (depending upon the position of the coil in the slot) the conductors in the slot affected are not all carrying the full armature current. This will be seen by reference to Fig. 65, where coil A (consisting of two turns) is just about to be short-circuited by the brush. At this instant the current in the coil-sides B and D is  $i = 2I_c \times \frac{1}{3.5} = 0.572I_c$ , as indicated by the diagram sketched on the brush of width  $W$  covering three and one-half bars, the

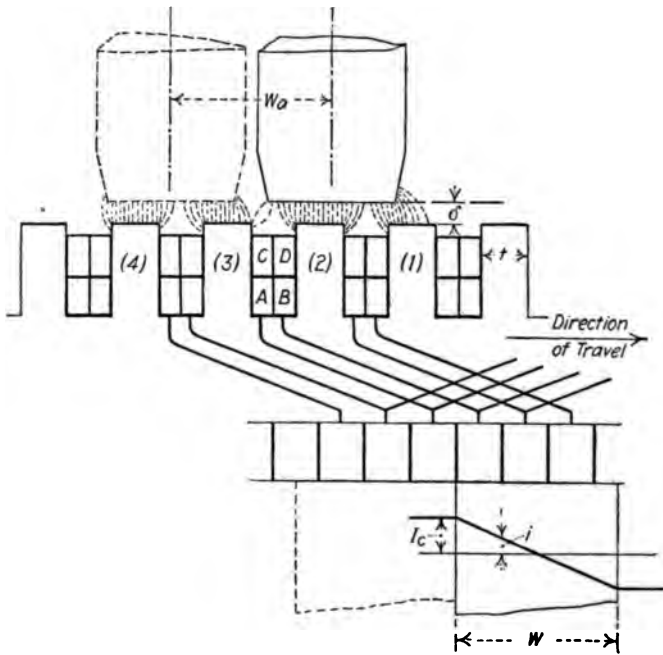

FIG. 65.—Illustrating example of interpole design.

straight-line law of current variation being assumed. At the end of commutation, when the position of the affected slot relatively to brush and interpole is as indicated by the dotted lines, the current in all four coil-sides is  $-I_c$ . We may, therefore, assume the slot flux to be produced by a current of which the average value is not  $I_c = 76$  amp., but  $I_c \times \frac{3 + 0.572}{4} = 68$  amp. The slot flux  $\Phi_s$ , in formula (85), which is the "equivalent" value as-

suming the total slot flux to pass outward from the armature core through the teeth, is, therefore, by formula (77),

$$\Phi_{es} = \frac{1.6 \pi d}{3s} T I_c$$

whence,

$$\begin{aligned} \Phi_{es} l_a &= \frac{1.6 \pi \times 1.5 \times 4 \times 68 \times 11 \times 2.54}{3 \times 0.39} \\ &= 49,000 \text{ maxwells,} \end{aligned}$$

this being the equivalent slot flux taken over the full length of the armature.

Turning now to the flux leaving the armature in that part of the commutating belt which is not covered by the interpole, let the curve Fig. 66 represent the full-load flux distribution over

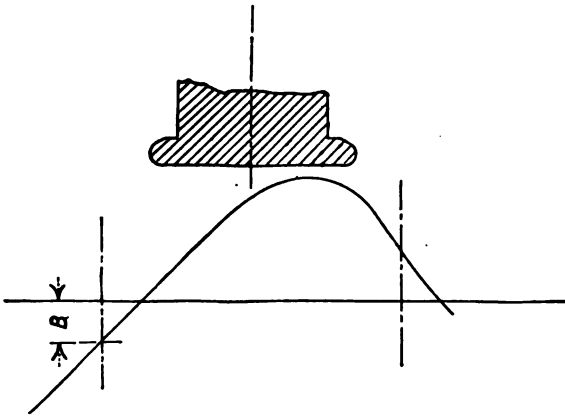

FIG. 66.—Flux curve showing density on geometric neutral line. (Calculated without interpoles.)

armature surface, calculated on the assumption that there are no interpoles. This is the flux curve *C*, derived in the manner outlined in Art. 43, Chap. VII, but with the brushes left in the no-load position. There will be no directly demagnetizing effect due to brush lead since the brushes will remain on the geometric neutral line. The flux density at a point midway between the two poles has the value *B*, which for the purpose of this example may be assumed to be 1,500 gauss.

If  $l_p$  = axial length of interpole (not yet determined), the total flux which must pass from interpole into armature teeth is

$$\Phi_c = \Phi_e + \Phi_{es} l_a + B W_a (l_a - l_p)$$

which is simply formula (85) with the armature flux per centimeter of length expressed as  $BW_a$  instead of  $\Phi_a$ . The axial length  $l_p$  of the interpole face can, therefore, be determined if a suitable value for the average air-gap density under full-load conditions is assumed. Let  $B_p$  stand for this value; then

$$B_p l_p W_a = \Phi_c \Phi_{ca} l_a + BW_a (l_a - l_p)$$

whence

$$l_p = \frac{\Phi_c + \Phi_{ca} + BW_a l_a}{W_a (B_p + B)} \quad (86)$$

If the flux densities are expressed in gausses, the dimensions must be in centimeters, and if  $B_p$  is taken as 4,500 gausses, the length  $l_p$  is found, by formula (86), to be 12.4 cm. or, say, 5 in.

The total flux in the interpole air gap at full load is then,

$$\begin{aligned} \Phi_c &= 64,800 + 49,000 + 1,500 \times 6.45 \times 1.375(11 - 5) \\ &= 193,600 \text{ maxwells.} \end{aligned}$$

Assuming a leakage factor of 1.9 and a cross-section under interpole winding of  $(5 \times 1\frac{1}{2})$  sq. in., the full-load density in the core of the interpole would be 7,600 gausses.

*Calculation of Ampere-turns Required on Interpole.*—Referring to Fig. 65, it will be seen that when the coil *A* is about to be short-circuited, the interpole flux enters the armature through the teeth 1 and 2. At the end of commutation this flux enters the teeth 3 and 4. The permeance of the air gap of length  $\delta$  may vary slightly with the change in the position of the armature teeth; it may be calculated by any of the approximate methods.<sup>1</sup> Assuming an actual air gap  $\frac{1}{4}$  in. long, the equivalent air gap might be 0.3 in. The full-load ampere-turns required to overcome air-gap reluctance will therefore be

$$\frac{0.3 \times 2.54 \times 4,500}{0.4\pi} = 2,720 \quad \checkmark$$

To this must be added the ampere-turns to oppose the armature m.m.f. If the reduction of current in the short-circuited coils is neglected, the armature ampere-turns per pole are

$$\begin{aligned} \frac{1}{2} \frac{ZI_c}{p} &= \frac{(120 \times 8) \times 76}{2 \times 6} \\ &= 6,080 \end{aligned}$$

If we neglect the very small m.m.f. required to overcome the reluctance of the interpole core, the total ampere-turns on each

<sup>1</sup> See Art. 36, p. 115.



interpole should be  $2,720 + 6,080 = 8,800$  at full load. The full-load current of the machine is  $200,000 \div 440 = 455$  amp., and the required number of turns is  $8,800 \div 455 = 19.35$ . In practice about 21 turns would be put on the interpole of this machine, and if necessary a diverter would be provided to adjust the current in accordance with results obtained on test.

**52. Prevention of Sparking—Practical Considerations.**—It is not suggested that the method of considering commutation phenomena as outlined above covers the subject completely. The designer aims at obtaining “ideal” commutation under certain load conditions, knowing well that, even when series-wound commutating poles are used, the required conditions cannot be exactly fulfilled at other loads. He relies on the resistance of the

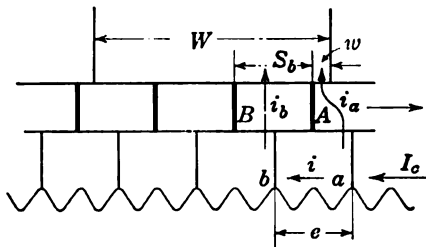

FIG. 67.—Armature coil near end of commutation period.

carbon brush to give sparkless commutation even when the conditions depart appreciably from those of “ideal” commutation. The extent to which the ideal condition can be departed from without producing destructive sparking is not easily determined except by experimental means.

In Art. 45, page 146 the effect of the brush-contact resistance was considered, and it was seen that the value of this resistance has no effect on the problem of commutation *provided the change of current in the short-circuited coil takes place in accordance with the “ideal” or straight-line law*. The reason is that, when “straight-line” commutation is obtained, the distribution of the current over the contact surface of a brush of rectangular section is necessarily uniform. If, now, we wish to examine the conditions of commutation when the changes of current do not follow the ideal straight-line law, it is necessary to consider the effect of the brush-contact resistance when the current density is no longer uniform over the entire surface. The diagram, Fig. 67, is gener-

ally similar to Fig. 56, except that the coil connecting segments *A* and *B* has moved nearer to the edge of the commutation zone. The distance, in inches, still to be travelled before the removal of the short-circuit is *w*, which is supposed to be only a small percentage of the total brush arc *W*.

Let *R* be the resistance, in ohms, of the coil connecting the commutator segments *A* and *B*.

$R_c$  = the contact resistance of the brushes per square inch of area.

$l_c$  = the total length, in inches, of the set of brushes measured parallel to the axis of rotation.

$\Delta$  = the average current density, in amperes per square inch, over the brush-contact surface. It will also be, approximately, the density over the surface  $S_b$  of the segment *B* (Fig. 67).

$\Delta_w$  = the maximum permissible current density over the surface of the brush tip of width *w*.

Summing up the e.m.fs. and potential differences in the path of the short-circuit (the resistance of the material in the body of the brush being neglected), we can write, for the value of the volts developed in the short-circuited coil at the instant considered,

$$e = iR + \Delta R_c - \Delta_w R_c$$

But

$$i = I_c - i_a$$

wherein the meaning of the symbols will be evident from an inspection of Fig. 67. This last equation may be written,

$$i = I_c - \Delta_w l_c w$$

Substituting in the previous equation, we get,

$$e = I_c R - \Delta_w l_c w R - R_c (\Delta_w - \Delta)$$

If, now, we imagine *w* to become smaller and smaller as it approaches zero value, the second term on the right-hand side of the equation becomes of relatively less and less importance, and we may therefore write,

$$e = I_c R - R_c (\Delta_w - \Delta)$$

which gives an approximate value for the permissible e.m.f. in the short-circuited coil at the end of the commutation period. If preferred, this equation may be put in the form

$$e = I_c R - R_c \Delta (k - 1) \tag{87}$$

wherein  $k$  is the ratio of the permissible density at brush tip to the average density over brush-contact surface.

For values of  $\Delta$  above 30 amp. to the square inch, the voltage drop  $R_c\Delta$ , with carbon brushes, is usually about 1 volt. It follows that, if the value of  $k$  may be as high as 2.5, the actual e.m.f. in the short-circuited coil may differ from the ideal e.m.f. by about 1.5 volts. This is, however, a case for experimental determination; but once a safe value for  $k$ —or for  $\Delta_w$ —has been determined, the allowable variation in the commutating flux  $\Phi_c$ —as given by formulas 82, page 164, and 85, page 167—may readily be calculated. If the assumed value of 1.5 volts variation is permissible, it follows that the amount by which the flux entering the teeth in the commutating zone may differ from the ideal value is

$$\begin{aligned}\Phi &= \frac{1.5t_c \times 10^8}{2T_c} \\ &= \frac{3t_c \times 10^8}{4T_c} \text{ maxwells}\end{aligned}\tag{88}$$

wherein  $t_c$  is the time of commutation in seconds, and  $T_c$  is the number of turns in the short-circuited coil.

Apart from all considerations of a mechanical nature, commutation can be improved by increasing the thickness of insulation between commutator bars. This might in many cases be made considerably thicker than the usual  $\frac{1}{32}$  in. with advantage in the matter of sparking; but it is not always easy to obtain large spacing between bars, and thick mica insulation is otherwise objectionable.

When calculating the equivalent slot flux, the assumption made virtually supposes the slot to contain a large number of small wires all connected in series. With solid conductors of large cross-section, the local currents in the copper would alter the distribution of the slot flux and call for a reversing field differing slightly from the field calculated by the aid of the formulas given in this chapter. Again, the field due to the armature m.m.f. is usually assumed to be stationary in space. This is practically true when the number of teeth is large and the brush arc is a multiple of the bar pitch. With few teeth and a brush covering a fractional number of bars, the oscillations of the armature field (of small magnitude but high frequency) may have some slight effect on commutation; but with



a better understanding of the main principles underlying commutation phenomena these and similar modifying factors of secondary importance tend to assume a less formidable aspect. The designer, who must of necessity be an engineer, desires to see clearly what he is doing. If he uses formulas of which he does not know the derivation or physical significance, he is working in the dark. In general, he asks for more physics and less mathematics. If he can picture the short-circuited coil cutting through the various components of the flux in the commutating zone, and understand how these flux components may be calculated within limits of accuracy that are generally satisfactory in practice, he will have a working knowledge of the phenomena of commutation which should be especially valuable in cases where test data cannot be relied upon.

**53. Mechanical Details Affecting Commutation.**—The quality of the carbon used for the brushes, together with the pressure between brush and commutator surface, will determine the heating due to friction, and therefore, to some extent, the dimensions and proportions of the commutator. The pressure between brush and commutator is usually adjusted by springs so that it shall be from 1 to 2 lb. per square inch of contact surface. In order to avoid excessive temperature rise, the current density is rarely allowed to exceed 30 or 40 amp. per square inch of brush-contact surface. A sufficient cooling surface is thus provided from which the heat developed through friction and  $I^2R$  loss may be radiated. The width of brush (brush arc) should lie within the limits of  $1\frac{1}{4}$  and  $3\frac{1}{2}$  commutator bars; and as a further check on the desirable dimensions, the width should not exceed  $\frac{1}{12}$  of the pole pitch referred to the commutator surface. Having determined the width of the brush, and decided upon a suitable current density, the total axial length per brush set may be calculated, and the length of the commutator decided upon.

The individual brush rarely exceeds 2 in., measured parallel to the axis of rotation, and when a greater length of contact surface is required, several brush holders are provided on the one spindle or brush arm. Even in small machines, the number of brushes per set should not be less than two, so as to allow of examination and adjustment while running. The final check in the matter of commutator design is the probable temperature rise; but this will be again referred to when considering losses and efficiency.

The curves, Figs. 68 and 69, give respectively the contact resistance and drop of potential for different current densities. Two curves are plotted in each case: the one referring to a hard

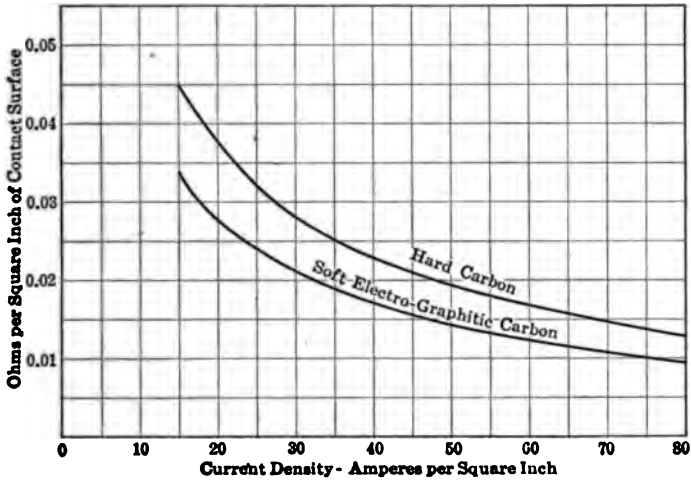

FIG. 68.—Contact resistance, carbon brushes.

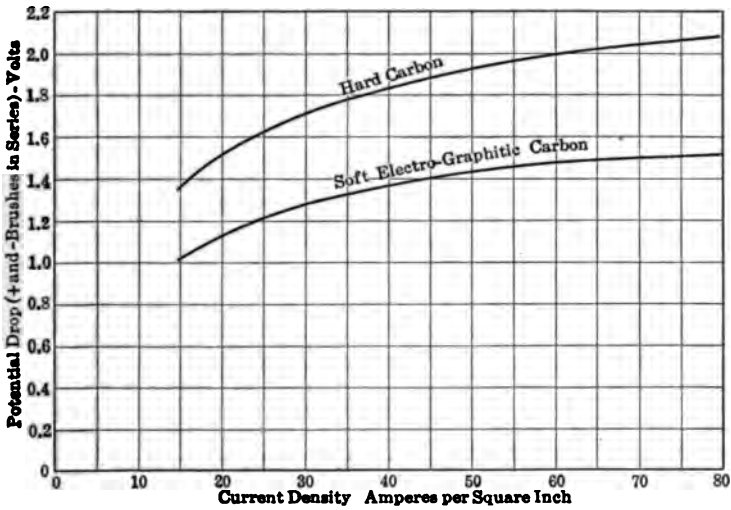

FIG. 69.—Pressure drop at contact surfaces, carbon brushes.

quality of carbon, and the other to the much softer electro-graphitic carbon which has a lower resistance and may be worked at a higher current density. An average pressure of 1.5 lb.



per square inch between contact surfaces has been assumed in order to avoid the plotting of a large number of curves. For high-voltage machines, the harder quality of carbon will generally be found most suitable. For low voltages, economy may frequently be effected by using the graphitic brushes with current densities as high as 60 amp. to the square inch of contact surface. It is an interesting, but not very clearly explained, fact that the temperature rise of the negative brushes is greater than that of the positive brushes. In other words, the watts lost are greater when the current flow—according to the popular conception—is from carbon to copper, than when it is from copper to carbon. The resistances given in Fig. 68 have been averaged for the + and - brushes.

On low-voltage dynamos, when the current to be collected is very large, copper brushes must be used. The resistance of the contact between brush and commutator is then much lower than with carbon brushes and the current density may be as high as 200 amp. per square inch of contact surface. The contact-surface resistance may be anything between 0.0007 and 0.0028 ohm per square inch, a safe figure for the purpose of calculating the brush losses being 0.002 ohm. If the current density at the contact surface is 150 amp. per square inch (a very common value), the total loss of pressure at the brushes will be  $0.004 \times 150 = 0.6$  volts, instead of about 2 volts, which is usual with carbon brushes.

The degree of hardness of the copper used for the commutator segments is a matter of importance; an occasional soft bar will invariably lead to sparking troubles because of unequal wear. A perfectly true cylindrical commutator surface is essential to sparkless running. The different sets of brushes should be "staggered" in order to cover the whole surface of the commutator and so prevent the formation of grooves. For the same reason, and also to ensure more even wear of the journals and bearings, some end play should be allowed to the shaft. In large machines it is not uncommon to provide some device, in the form of an electromagnet with automatically controlled exciting coil, to ensure that the desirable longitudinal motion of the rotating parts shall be obtained.

Owing to the hardness of the mica insulation relatively to that of the copper bars, there is a tendency for the mica to project slightly above the surface of the copper. This naturally leads

to sparking troubles, and it is not uncommon to groove the commutator between bars, cutting down the mica about  $\frac{1}{8}$  in. below the surface, leaving an air space as the insulation between the bars. This undercutting process may have to be repeated as the commutator wears down in use.

As the effects of any irregularities on the commutator surface are accentuated by high speeds, it is usual to limit the surface velocity of the commutator to about 3,000 ft. per minute when possible. The diameter of the commutator in large machines is generally about 60 per cent. of the armature diameter, while, in small machines, this ratio may be as high as 0.75.

The design of brushes and holders is a matter of great importance; as a general rule, it may be said that the lighter the moving parts of brush and holder, the better the conditions in regard to sparking when the surface of the commutator is not absolutely true.

**54. Heating of Commutator—Temperature Rise.**—In some cases it is necessary to provide special means of ventilation to keep the temperature of the commutator within reasonable limits; but as a rule a sufficiently large cooling surface may be obtained without unduly increasing the size and cost of the commutator.

The losses to be dissipated consist of:

1. The  $I^2R$  loss at brush-contact surface.
2. The loss due to friction of the brushes on commutator surface.

The  $I^2R$  loss in the commutator segments is relatively small and can usually be neglected.

The watts lost under item (1) are approximately  $2I$ , where  $I$  is the total current taken from the machine. This assumes an average value of 2 volts for the total potential drop between commutator and carbon brushes. For a more exact determination of this electrical loss, the curves of Fig. 69 can be used. As the current passing into all the positive brushes includes the shunt exciting current, an allowance should be made for this. Moreover, the assumed condition of uniform current density over brush-contact surface will not be fulfilled in practice. The uneven distribution of current density will increase the losses, and it will be advisable to add about 25 per cent. to the values of voltage drop as read off the curves of Fig. 69.

The losses under item (2) are less easily calculated because

the coefficient of friction will depend not only upon the quality of the carbon brush but also on the condition of the commutator surface.

Let  $P$  = the pressure of the brush on the commutator, in pounds per square inch of contact surface (usually from 1 to  $1\frac{3}{4}$  lb.);

$c$  = the coefficient of friction;

$A$  = the total area of brush contact surface (square inches);

$v_c$  = the peripheral velocity of the commutator in feet per minute;

then the friction loss is  $cPAv_c$  foot-pounds per minute.

If  $D_c$  is the diameter of the commutator in inches, and  $N$  is the number of revolutions per minute,

$$v_c = \frac{\pi D_c N}{12}$$

The friction loss, expressed in watts, is

$$W_f = \frac{cPAND_c\pi \times 746}{12 \times 33,000} \quad (89)$$

The value of  $c$  for a good quality of carbon brush of medium hardness may lie between 0.2 and 0.3; but this coefficient is not reliable as it depends upon many factors which cannot easily be accounted for.

The watts that can be dissipated per square inch of commutator surface will depend on many factors which cannot be embodied in a formula. The peripheral velocity of the commutator surface will undoubtedly have an effect upon the cooling coefficient; but the influence of high speeds on the cooling of revolving cylindrical surfaces is not so great as might be expected. The design of the risers—*i.e.*, the copper connections between the commutator bars and the armature windings—has much to do with the effective cooling of small commutators; but this factor is of less importance when the axial length of the commutator is considerable.

Some designers consider only the outside cylindrical surface of the commutator when calculating temperature rise; but this leads to unsatisfactory results in the case of short commutators. In the formula here proposed, it is assumed that the risers add to the effective cooling surface up to a limiting radial distance

of 2 in.; that is to say, if the risers are longer than 2 in., the area beyond this distance will be considered ineffective in the matter of dissipating heat losses occurring at the commutator surface. The external surface of the carbon-brush holders is helpful in keeping down the temperature and it will be taken into account by assuming that the cooling surface of the commutator is increased by an amount equal to  $2l_c b$  sq. in.; where  $l_c$  is the total axial length of one set of brushes, and  $b$  is the total number of brush sets.

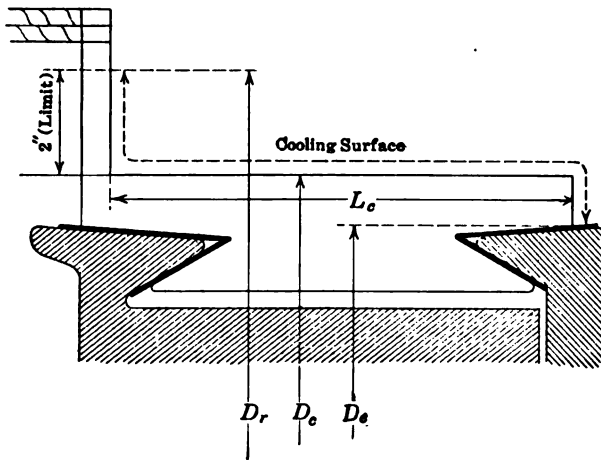

FIG. 70.—Cooling surface of commutator.

The cooling area, as indicated in Fig. 70, will therefore consist of the cylindrical surface  $\pi D_c L_c$ ; the surface of the risers  $\frac{\pi}{4} (D_r^2 - D_e^2)$ ; the surface of the exposed ends (if any) of the copper bars, of value  $\frac{\pi}{4} (D_e^2 - D_o^2)$ ; and the allowance of  $2l_c b$  for the brush holders.

The empirical formula here proposed for calculating the temperature rise of the commutator is

$$W = TA \left( 0.025 + \frac{v_c}{100,000} \right) \tag{90}$$

where  $W$  = the total watts to be dissipated.

$A$  = the cooling area computed as above (square inches).

$v_c$  = the peripheral velocity of the cylindrical surface of the commutator in feet per minute.

$T$  = the temperature rise in degrees Centigrade.

The allowable temperature rise, *i.e.*, the limiting value of  $T$  in formula (90) is 45° to 50°C.

The mechanical construction of the commutator is a matter of great importance, and when the peripheral velocity exceeds 4,000 ft. per minute, special means may have to be adopted to ensure satisfactory operation. For instance, if the axial length is great, it may be necessary to provide one or more steel rings which can be slipped over the surface of the bars and shrunk on, to prevent displacement of the bars or loosening of the mica insulation owing to vibration or centrifugal action. These mechanical details must, however, be studied elsewhere as their discussion is not included in the scope of this book. A sufficient radial depth of commutator bar must be provided in order that the strength and stiffness may be sufficient to resist the effects of centrifugal force. This dimension of the copper segments should include an allowance of  $\frac{3}{8}$  to  $\frac{3}{4}$  in. for wear, as the commutator must be large enough in diameter to allow of its being turned down occasionally without reducing the cross-section of the segments to a dangerous extent. The mechanical considerations are the controlling factors in this connection, as the cross-section is usually ample to carry the required current. The pitch of the bars at the commutator surface should not be less than 0.2 in., because, with the mica of the usual thickness (0.03 to 0.035 in.) the bar would be mechanically unsatisfactory if the thickness were reduced below this limit.



CHAPTER IX  
**THE MAGNETIC CIRCUIT—DESIGN OF FIELD  
 MAGNETS—EFFICIENCY**

**55. The Magnetic Circuit of the Dynamo.**—Once the total flux per pole necessary to develop the required voltage is known, it is an easy matter to design the complete magnetic circuit and provide it with a suitable winding in order that the required flux shall enter the armature. The method of procedure is similar to that adopted in the design of a horseshoe lifting magnet (see Art. 16, Chap. III), and for this reason the subject will be dealt with very briefly in this chapter.

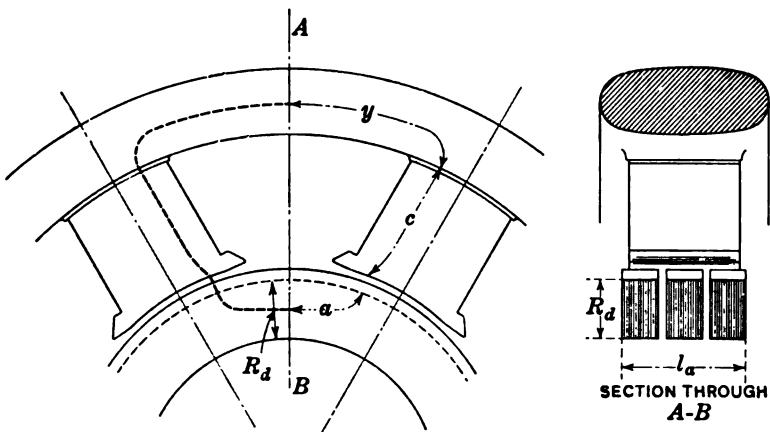

FIG. 71.—Magnetic circuit of multipolar dynamo.

Fig. 71 shows the flux paths in a multipolar dynamo. If we know the flux density in the iron at all parts of the magnetic circuit and the average lengths,  $y$ ,  $c$ , and  $a$ , of the flux paths per pole in the yoke, pole cores, and armature, respectively, we can, by referring to the  $B$ - $H$  curves of the materials used in the construction, easily calculate the ampere-turns necessary to overcome the reluctance of these portions of the magnetic circuit. The greatest part of the total reluctance is in the air gap and

teeth; but the amount of excitation required to send the flux through air gap, teeth, and slots, has already been calculated, and may be read off the curve *a* of Fig. 49, page 133. The air-gap density to be used in obtaining this component of the total field ampere-turns will be the *maximum* value of the air-gap density as obtained from the flux curve *A* of Fig. 51 (for open-circuit conditions).

The necessary cross-section of iron in the various parts of the magnetic circuit is readily calculated if the leakage factor can be estimated; but the length of the pole core (the dimension *c* in Fig. 71) will depend upon the number of ampere-turns required, and therefore on the length of the air gap, which must be decided upon at an early stage in the design (see end of Art. 36, page 119).

Let  $(SI)_{gt}$  be the ampere-turns required at full load for the air gap, teeth, and slots; then, if we assume a depth of winding on the field coils of  $1\frac{3}{4}$  in., a winding space factor of 0.5, and a current density of 1,000 amp. per square inch of copper cross-section, the length of the winding space (which is approximately equal to the length of *c* of Fig. 71) would be:

$$c = \frac{(SI)_{gt}}{875} \quad (91)$$

If, now, we make the further assumptions that  $(SI)_{gt}$  is 50 per cent. greater than the ampere-turns necessary to overcome the reluctance of the actual air clearance of length  $\delta$  in., and that the air-gap density  $B_g = 8,000$  gausses, we may write:

$$\frac{0.4\pi(SI)_{gt}}{1.5} = \delta \times 2.54 \times 8,000$$

and, putting  $875c$  in place of  $(SI)_{gt}$ , we get the relation

$$\begin{aligned} c &= \delta \times \frac{2.54 \times 8,000 \times 1.5}{0.4\pi \times 875} \\ &= 28\delta \text{ (approximately)} \end{aligned} \quad (92)$$

For a preliminary calculation of the ampere-turns required for the complete magnetic circuit, a value of *c* (the length of the pole) rather greater than as calculated by formula (91) or (92) may be selected. This dimension will be subject to modification if it is afterward found that the cooling surface of the field windings is insufficient to prevent an excessive rise of temperature.

**56. Leakage Factor in Multipolar Dynamos.**—Apart from the useful flux entering the armature core, there will, be in every

design of dynamo, some leakage flux between pole shoes and between pole cores which, in a plane normal to the axis of rotation, will follow paths somewhat as indicated in Fig. 72. The amount of this leakage flux is not easily calculated; but it can be approximately predetermined by applying the conventional formulas of Art. 5, Chap. II, or by the graphical method as outlined in Art. 39, Chap. VII. Other approximate graphical methods are used by designers<sup>1</sup> and, in the case of radical departures from standard types, some such method of estimating the leakage flux must be adopted. It will, however, be found

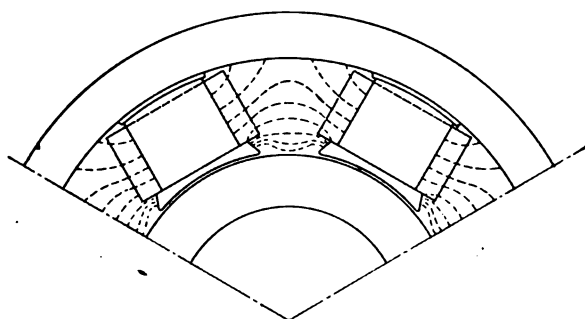

FIG. 72.—Leakage flux in multipolar dynamo.

that the leakage factor does not vary appreciably in modern designs of multipolar dynamos, and the following values may be adopted for the purpose of determining the necessary cross-sections of the pole cores and frame.

Kw. output of dynamo	Leakage coefficient
20 to 50	1.15 to 1.3
50 to 150	1.14 to 1.26
150 to 250	1.13 to 1.23
250 to 400	1.11 to 1.19
500 and larger	1.10 to 1.16

**57. Calculation of Total Ampere-turns Required on Field Magnets.**—The maximum values of the m.m.f. curves obtained by the method followed in Chap. VII (see Arts. 40 and 43) give the ampere-turns per pole required to overcome the reluctance of the air gap, teeth and slots. The balance of the total ampere-turns is easily calculated since the lengths and cross-sections of the various parts of the magnetic circuit are

<sup>1</sup>See p. 326 of WALKER'S "Specification and Design of Dynamo-electric Machinery."

known, and a suitable leakage factor may be selected from the table in the preceding article. The method of procedure is exactly as explained in connection with the design of a horseshoe lifting magnet (see Art. 16, page 52), and it will be again followed in detail when working out a numerical example of continuous-current generator design. The flux path of average length is indicated in Fig. 71. There may be some doubt as to what is the proper value to take for the length of the path  $a$  in the armature core below the teeth, because the flux density will be less uniform in this part of the magnetic circuit than in the poles and yoke. As a matter of fact, the ampere-turns necessary to overcome the reluctance of the armature core (apart from the teeth) are but a small percentage of the total, because the flux density must necessarily be low to avoid large losses due to the reversals of magnetic flux. It is, therefore, something of a refinement to take account of the unequal distribution of the flux in the armature core; but if the length of the path  $a$  of Fig. 71 be taken as one-third of the pole pitch  $\tau$ , a more accurate value for the ampere-turns will be obtained than if the length were measured along the curved path shown in the illustration. It is, of course, understood that the density to be used in the calculation is the maximum flux density at the section midway between the poles, on the assumption that the flux is uniformly distributed over this section. Thus, if  $\Phi$  is the useful flux per pole entering the armature core, and  $R_a$  is the radial depth of stampings below the teeth, the maximum density in armature core to be used in the calculations is  $\frac{\Phi}{2R_a l_n}$  where  $l_n$  stands, as before, for the net axial length of the armature.

Solid-pole shoes are rarely used in connection with armatures having open slots. With semi-closed slots, or even with open slots if the air gap is large, the eddy-current losses in solid-pole shoes may be very small, but laminated pole pieces are now the rule rather than the exception. The thickness of the steel sheets used to build up the pole pieces is usually greater than that of the armature punchings, a thickness of 0.025 in. being fairly common. In small machines it is sometimes economical to construct the complete pole of sheet-steel stampings, as this dispenses with the labor cost of fitting a separate built-up pole piece on the solid pole core.



Referring to Fig. 49 on page 133, the curve (a) was plotted by assuming different values of air-gap density; it shows the relation between the ampere-turns required for air gap, teeth and slots, and the air-gap density over the slot pitch at the center of the pole face. We are now in a position to plot an open-circuit saturation curve which shall include the ampere-turns necessary to overcome the reluctance of all parts of the magnetic circuit; but instead of giving the relation between total ampere-turns per pole and the air-gap density, it will be more convenient to plot a curve connecting field ampere-turns and e.m.f. generated in the armature. This can easily be done since we know the total flux per pole and the generated e.m.f. corresponding to the value  $B_a$  of the maximum air-gap density (Fig. 49). Thus, in Fig. 73 the distance  $OP_a$  is the same as in Fig. 49, but the vertical scale has been altered so that the corresponding value  $E_o$  as read off the dotted curve of Fig. 73 now stand for the volts developed in the armature by the cutting of the flux, instead of the air-gap density under the center of the pole face. The full-line curve of Fig. 73 is the open-circuit characteristic of the whole machine. It gives

the connection between field ampere-turns per pole and the terminal voltage on open circuit, on the understanding that the speed is constant. The additional ampere-turns required to overcome the reluctance of the field poles, yoke, and armature core, account for the space between the full-line and dotted curves. This no-load saturation curve for the complete machine has been re-drawn in Fig. 74. Here  $OE_o$  is the terminal voltage on open circuit;  $OE_t$  is the terminal voltage at full load (the machine is assumed to be over-compounded); and  $OE_d$  is the necessary *developed* voltage at full load, *i.e.*, the voltage that must be generated in the armature conductors by the cutting of the flux in order that the terminal voltage at full load shall be  $OE_t$ .

Draw a straight line connecting the origin,  $O$ , of the curve and the point  $F$  corresponding to the no-load voltage, and produce this to  $G$  where it meets the horizontal line representing full-

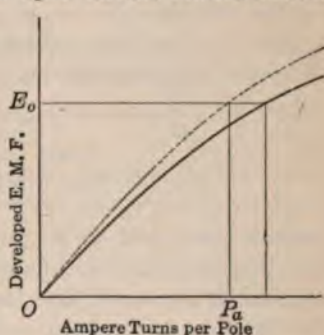

FIG. 73.

Draw a straight line connecting the origin,  $O$ , of the curve and the point  $F$  corresponding to the no-load voltage, and produce this to  $G$  where it meets the horizontal line representing full-



load terminal voltage. Then, since the ampere-turns on the shunt at no load are  $OA$ , they will obviously have increased to  $OB$  at full load on account of the higher terminal voltage (the "long shunt" connection is here assumed). The ampere-turns necessary to produce the required full-load flux will be  $OC$ ; but the field excitation must be greater than this in order to balance the distortional and demagnetizing effects of the armature current. It was found that the ampere-turns necessary to counteract the effects of the armature current were represented by the distance  $P_bP_a$  in Fig. 49 (Art. 42, page 133). These

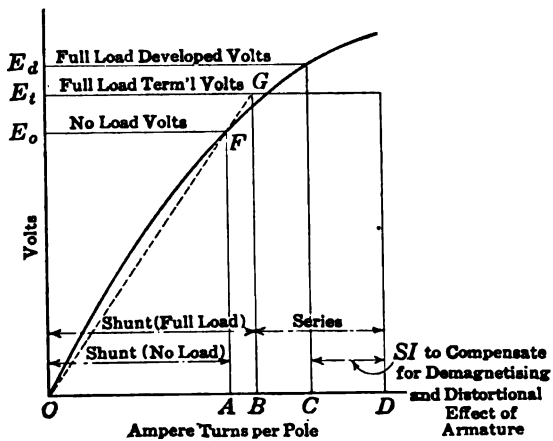

FIG. 74.—Open-circuit saturation curve of dynamo.

ampere-turns had to be put on the field poles, not to increase the air-gap flux and thus develop a higher voltage, but merely to counteract the effects of the armature current and restore the air-gap flux to its original value on open circuit. It is therefore correct to say that additional ampere-turns approximately equal to this amount must be added to the field windings in order that the necessary flux shall be cut by the armature conductors. This addition is shown in Fig. 74, where the distance  $CD$  has the same value as  $P_bP_a$  in Fig. 49. It follows that  $OD$  represents the total ampere-turns required per pole at full load. Of this total amount,  $OB$  will be due to the shunt winding, and the balance,  $BD$ , must be provided by the series winding.

**58. Arrangement and Calculation of Field Windings.**—Since the ampere-turns required in the shunt winding have now been

determined, the calculation of the size of wire for a given voltage may be proceeded with exactly as explained in connection with the winding of magnet coils (see Art. 10, Chap. II). The allowable cooling surface is not quite the same as for the coils of lifting magnets, because the fanning effect of the rotating armature is to some extent beneficial; but it will be convenient to consider the heating effects of the shunt and series coils together, and the question of cooling coefficients for use in predetermining temperature rise will therefore be taken up later.

*Shunt Field Rheostat.*—Even when the machine is compounded by the addition of a series winding, it is usual to provide an adjustable resistance in series with the shunt winding. This field rheostat allows of the excitation being kept constant notwithstanding the fact that the shunt winding will not have the same resistance when cold as it will have when a continuous run of several hours' duration has raised the temperature of the coils. The rheostat also allows of final adjustments being made after the machine has been built and tested.

In compound-wound generators it is customary to allow a voltage drop in the rheostat amounting to 15 or 20 per cent. of the total terminal pressure; and a sufficient number of contacts should be provided to avoid a variation of more than  $\frac{1}{2}$  to 1 per cent. change of voltage when cutting in or out sections of the rheostat.

The size of wire for the shunt field coils should therefore be calculated on the assumption that the impressed voltage is 15 to 20 per cent. less than the terminal voltage of the machine. It will generally be found desirable to connect the windings on all the poles in series. With shunt-wound dynamos, the field rheostat plays a more important part: it must be designed to give the required variation in field strength between no load and full load, at constant speed, or, in the case of a motor, to provide for the required speed variation. The amount by which the excitation has to be varied—apart from the requirements to compensate for the effects of temperature changes—may be determined by reference to the saturation curve as drawn in Fig. 74.

In a well-designed machine, the  $I^2R$  losses in the shunt field winding should not greatly exceed the values given below, where the loss is expressed as a percentage of the rated output of the dynamo:

Output of machine, kilowatts	Exciting current, percentage of total current
10	3.5
20	3.0
50	2.4
100	2.0
200	1.7
300	1.6
500	1.5
1,000 and larger	1.3 to 1.0

*Series Windings.*—The series winding on the field magnets carries the main current from the machine and thus adds to the constant excitation of the shunt coils a number of ampere-turns generally in accordance with the demand for a stronger field. It is not usual to wind the series turns on the outside of the shunt wire; but this may be done in small machines. The series turns are usually placed at one end of the pole, either up against the pole shoe, or—more commonly—near the yoke ring. Space must, therefore, be left for the series winding at the time when the dimensions of the shunt coil are decided upon. The total winding space available may be divided in proportion to the ampere-turns required on the shunt and series coils respectively. The coils near the yoke ring, in a machine with revolving armature, are frequently made to project from the pole core farther than the coils near the pole shoe, partly because the space available between the poles increases with the radial distance from the center, but also because the cooling effect of the air thrown from the rotating armature will be greater if the field windings are stepped out in this manner.

The construction and insulation of field windings deserves careful attention; but for details of this nature, the designer must rely largely upon the practice of manufacturing firms and his own common sense. The pressures to be considered in D.C. designs are not high, and the chief points requiring attention are the proper arrangement and the insulation of the starting and finishing ends of the coils.<sup>1</sup>

The size of conductors for use in the series winding may be determined by considerations of permissible voltage drop, or, if this is unimportant, the temperature rise will be the determin-

<sup>1</sup> Much useful information regarding the insulation of windings will be found in Chap. IV of "Insulation and Design of Electrical Windings," by A. P. M. FLEMING and R. JOHNSON (LONGMANS & Co.).

ing factor. In the latter case, the allowable current density will be about the same as in the shunt coils, unless the series turns are next to the pole shoe, in which case a slightly higher density would be permissible because of the better ventilation. If the current to be carried exceeds 100 amp., the coils may be made of flat copper strip wound edgewise by means of a special machine. For smaller currents, cotton-covered wires of square or rectangular section are commonly used; the round wire being rarely employed, unless the diameter is less than that of No. 8 B. & S. gage.

On account of the method of connecting the series coils between adjacent poles on a multipolar dynamo, there will be an odd number of turns per pair of poles, or a whole number plus a half turn on each pole. This will easily be understood by referring to Fig. 75 which is supposed to show a portion of the

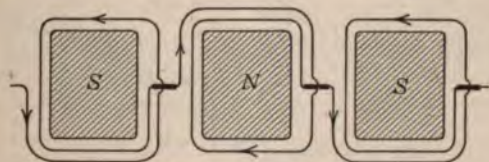

FIG. 75.—Diagram of series field winding.

crown of poles, looking down through the yoke ring onto the cylindrical surface of the armature. The number of ampere-turns required per pole being known, the number of turns in the series winding can easily be calculated. It may not be possible to put this exact number on the pole, and a slightly greater number of turns is, therefore, provided, the excess of current being shunted through a *diverter*. This is merely a resistance connected as a shunt to the series winding. Thus if the required series ampere-turns per pole are 2,000, and the current 300 amp., the calculated number of turns per pole is 6.66. Since  $6\frac{1}{2}$  turns will not be sufficient, the winding may consist of  $7\frac{1}{2}$  turns, and the current required through the coils is, therefore,  $2,000/7.5 = 267$  amp. The balance of 33 amp. must be shunted through the diverter, the resistance of which is easily calculated after determining the resistance of the series coils from the known cross-section and computed length of the winding.

**59. Temperature Rise of Field Coils.**—On account of the proximity of the shunt and series windings, it is advisable to

consider the joint losses in connection with the entire cooling surface. The reader is referred to Art. 11, Chap. II, where the heating of magnet coils was discussed. The problem of keeping the temperature rise of field coils within safe limits (40° to 45°C.) is complicated by the fact that the fanning action of the rotating armature will have an effect upon the cooling coefficient; but this has been taken into account in the curves of Fig. 76. The

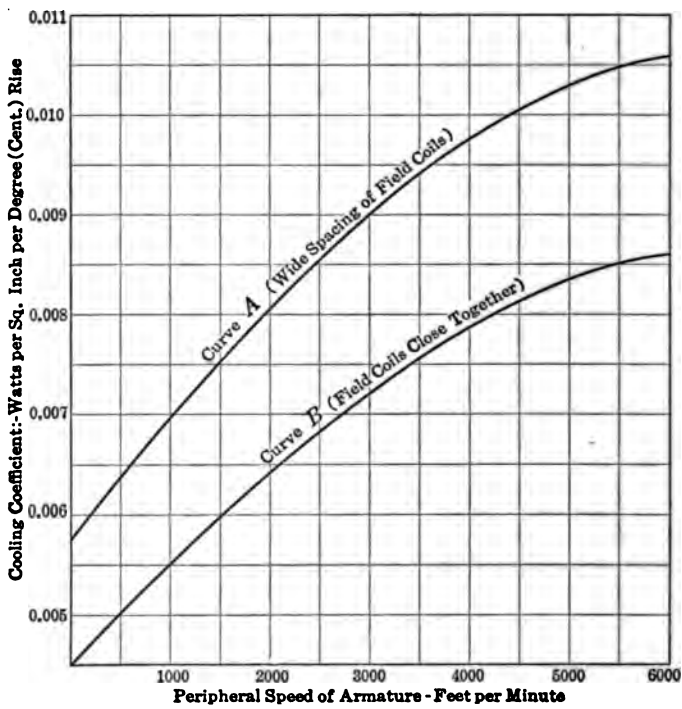

FIG. 76.—Cooling coefficients for field coils of dynamos.

curve marked A applies to machines with wide spacing between poles, and good ventilation, while the curve B should be used when the main poles are close together, or when commutating poles interfere with the free circulation of air round the main windings. The coefficient obtained from the curves, being *watts per square inch per degree rise*, is the reciprocal of the coefficient *k* used in the chapter on magnet design; but the cooling surface considered is the same, namely, the total external surface of the winding, including the two ends and also the inner surface



near the iron pole core. The cooling coefficient will necessarily depend upon the type and size of the machine, and it should, if possible, be determined from tests made on machines generally similar to the one being designed. The modern tendency in design is all toward increased output by improvements in the qualities of materials and in methods of ventilation. Field coils are now frequently built with sectionalized windings so arranged that the air has free access, not only between the subdivisions of the winding, but also between the inside of the coils and the pole core. The gain is not always proportionate to the total cost and space required; but the cooling coefficients given in Fig. 76 would not be applicable to such designs without modification. Each manufacturer has his own data to guide him in his calculation of new designs; but even if such data were available for publication, it would be of little value without the experience which enables the designer to apply it intelligently to a practical case.

**60. Efficiency.**—The efficiency of a dynamo is the ratio of power output to power input, or,

$$\text{Efficiency} = \frac{\text{output}}{\text{output} + \text{losses}}$$

In computing the total losses, an estimate has to be made of the power lost through windage and bearing friction. It is almost impossible to predetermine these quantities accurately. The loss due to air friction will depend upon the design of the armature and arrangement of poles and frame, apart from the actual surface velocity; while the bearing friction will depend upon the number and size of the bearings, the method of lubrication, the weight of the rotating parts, and the method of coupling to the prime mover. The factors to be taken into account are so numerous and so difficult to determine that, in the case of new designs or departures from standard types, it is usual to group these losses together and make a reasonable allowance for them in the calculations of efficiency. The friction losses will increase with the surface velocities; but since the volume, and therefore the weight, of the rotating armature of a machine of given output will decrease with increase of speed, it is found that the total friction losses may be expressed as a percentage of the total output, and this percentage will not vary greatly in machines of different outputs and speeds. The

following figures indicate approximately the losses due to windage and bearing friction in modern types of dynamos.

Rated kw. output	Friction losses (per cent.)
10	3.0
30	2.5
60	2.0
100	1.5
200	1.0
500	0.75
Large machines	0.6

*Closer Estimate of Hysteresis and Eddy-current Losses in Armature Teeth.*—For the purpose of calculating the armature losses with sufficient accuracy to determine whether or not the temperature rise is likely to be excessive, it was suggested in Art. 31 (page 103), that the average value of the *apparent* tooth density be used in calculating the iron loss in the teeth. When the tooth density is very high, or the taper of the tooth considerable, this method will not yield very accurate results. It is the *actual* tooth density which, together with the frequency, will determine the losses per pound in a given quality of steel punchings; and this actual tooth density may be read off a curve plotted from the formulas derived in Art. 37, Chap. VII.

The tooth density with which we are concerned in the calculations of power losses, is obviously the maximum density, and this will occur when the tooth is in the zone of maximum air gap density, the value of which can be read off the full-load flux distribution curve, *C*, derived as explained in Art. 43, Chap. VII.

When the tooth is not of the same cross-section throughout its length, the question arises as to what particular value of the actual tooth density should be taken for the purpose of calculating the iron losses. The tooth might be divided into a number of imaginary sections concentric with the shaft, and the watts lost in the elemental sections could be calculated and totalled; but this would be a lengthy and tedious process, and the following approximation will usually give results of sufficient accuracy for practical purposes.

First calculate the actual flux density at the root of the tooth (see Art. 37, page 119), and then again, at two other sections, namely, near the top where the circumference of the "equivalent"

smooth core armature would cut through the tooth, and also at a point midway between these two extremes. These sections are shown in Fig. 38, page 122; and if the assumption is made that no flux lines either enter or leave the sides of the tooth, the densities at the middle and top of the tooth can readily be expressed in terms of the root density since they will vary inversely as the cross-section of the tooth. If, now, the iron loss in watts per pound is read off the curves of Fig. 34, page 102, for the three selected values of the tooth density, the *average* loss per pound multiplied by the total weight of iron in the teeth, will represent, within a reasonable degree of accuracy, the total loss in the teeth of the machine.

A high tooth density is an advantage from the point of view of field distortion. It can easily be understood that a high flux density, by saturating the teeth, will have a tendency to resist the changes in the air-gap flux distribution, brought about by the cross-magnetizing effect of the armature currents; and it is therefore advisable to check the approximate estimate of tooth losses with the results obtained by the more exact method of calculation.

In predetermining the efficiency, it is important that all the power losses in the machine be taken into account. These must include the losses in rheostats or diverters, which may be considered as part of the machine. A complete list of the losses to be evaluated when predetermining the efficiency will be found in the following chapter, where a numerical example will illustrate in detail the steps to be followed in designing a dynamo.

As a check on calculations, the efficiencies in the following tables may be referred to. They represent a fair average of what may be expected in a machine of modern design.

FULL-LOAD EFFICIENCIES OF DYNAMOS	
Kw. output	Efficiency, per cent.
10	86.0
20	87.6
30	88.8
40	89.7
50	90.3
75	91.2
100	91.6
200	92.0
500 and larger	93 to 95

## EFFICIENCIES OF DYNAMOS WHEN NOT DELIVERING FULL-LOAD CURRENT

Output as fraction of full load	Size of machine (Rated kw. output)	
	10 kw.	200 kw.
$\frac{1}{4}$ .....	70.0 per cent.	86 per cent.
$\frac{1}{2}$ .....	80.0 " "	91 " "
$\frac{3}{4}$ .....	84.5 " "	92 " "
Full load.....	86.0 " "	92 " "

## CHAPTER X

### PROCEDURE IN DESIGN OF D.C. GENERATOR— NUMERICAL EXAMPLE

**61. Introductory.**—Since the procedure about to be followed in working out a numerical example in dynamo design is not likely to meet with the approval of every practical designer, it is well to remember that an attempt is here made to base the work on fundamental principles and show how these principles may be applied in the detailed design of dynamo-electric machinery. The method here presented is one that will yield very satisfactory results when developing new types of machines, or when no account need be taken of existing patterns or tools. The practical designer is usually compelled to use stock frames and armature punchings, and adapt these to the requirements of the specification. He must effect some sort of compromise between the ideal design and a design that will comply with manufacturing conditions. In the method here followed, the assumption is made that the designer is given a free hand to produce a machine that shall, in all respects, be suitable for the work it has to perform, and of which the cost and efficiency shall be generally in accordance with present-day requirements. The various steps in the electrical design of a D.C. generator will be followed in logical sequence, and if the work appears unnecessarily detailed and drawn out, it must be remembered that the method has an educational, apart from a practical, value; it illustrates the application of theoretical principles to a concrete case, and shows how the practice of engineering is largely a matter of scientific guesswork. The experienced designer will be able to skip many of the intermediate steps here purposely included; because he will be able to rely on the engineering judgment he has acquired during years of practice in similar work. The point that must never be lost sight of is that, when an engineer makes a guess in respect to a dimension or any quantity of doubtful or indeterminate value, he is always able to check



the accuracy of his estimate by satisfying himself that the results obtained accord with the known laws of physics.

Since the design of commutating poles was treated at some length in the chapter on commutation (see Art. 51, Chap. VIII), it is proposed to select for the purpose of illustration a machine of comparatively small output, and endeavor to obtain satisfactory commutation without the addition of interpoles.

**62. Design Sheets for 75-kw. Multipolar Dynamo.**—The particulars contained in the following design sheets are more than sufficient for the needs of the practical designer; but they serve a useful purpose as a guide in making the calculations. The items are numbered for easy reference, and it will be found convenient to calculate the required dimensions and quantities generally in the order given, although the particular arrangement here adopted need not be adhered to rigidly. Two columns are provided for the numerical values, and they are supposed to be filled in as the work proceeds. The first of these columns is to be used for assumed values or preliminary estimates; while the last column is reserved for the corrected final values.

The actual calculations will follow the design sheets, and they will be shown in sufficient detail to be self-explanatory. The calculation of items of which the numerical values are obviously derived from previously obtained quantities will not always be shown in detail. The design sheets should be followed item by item, and where the method of calculation is not clear, the succeeding pages may be consulted for explanations and references to the text.

The machine to be designed is for a continuous output of 75 kw. The terminal voltage on open circuit is 220; but it is required to raise this to 230 at full load in order to compensate for loss of pressure in cables between the dynamo and the place where the power is utilized. The machine is therefore over-compounded. It is to be belt-driven at a constant speed of 600 revolutions per minute. The temperature rise is not to exceed 40°C. after a full-load run of not less than 6 hr. duration.

All numerical calculations have been worked out on the slide rule, and scientific accuracy in the results is not claimed.

**PROCEDURE IN DESIGN OF D.C. GENERATOR 201**

**DESIGN SHEET FOR CONTINUOUS-CURRENT GENERATOR**

SPECIFICATION	Symbols	Preliminary or assumed values	Final values
1. Kw. output.....			75
2. No-load terminal voltage.....			220
3. Full-load terminal voltage.....			230
4. Speed, r.p.m.....			600
5. Permissible temperature rise.....	$T =$		40°C.
<b>PRELIMINARY ASSUMPTIONS AND CALCULATIONS</b>			
6. Number of poles.....	$p =$	4	4
7. Frequency.....	$f =$	20	20
8. Per cent. armature surface covered by poles.....	$r =$	0.72	0.72
9. Specific loading of armature.....	$q =$	475	461
10. Type of armature winding (series or multiple).....			lap.
11. Apparent air-gap density (open circuit).....	$B_g =$	8,000	
12. Line current.....	$I =$		326
13. Armature current (per circuit).....	$I_a =$	83.4	82.6
14. Armature diameter (inches).....	$D =$	19.63	19.5
15. Peripheral velocity (feet per minute).....	$v =$		3,070
16. Total number of face conductors.....	$Z =$	350	342
17. Armature ampere-turns per pole.....		3,650	3,565
18. Length of air gap.....	$\delta =$	0.228	0.25
19. No-load flux per pole (maxwells).....	$\Phi =$	6,290,000	6,430,000
20. Pole pitch (inches).....	$\tau =$		15.34
21. Pole arc (inches).....		11.05	11
22. Area under pole face (square inches).....		122	
23. Axial length of armature (gross).....	$l_a =$	11.1	11
24. Axial length of pole face.....		10.6	10.5
25. Cross-section of each armature conductor (square inches).....		0.0402	0.039
26. Dimensions of armature conductor (inches).....			$\frac{1}{4} \times \frac{1}{16}$
27. Number of slots.....		57	57
28. Number of inductors per slot.....		6	6
29. Slot pitch (inches).....	$\lambda =$		1.076
30. Slot width (inches).....	$s =$		0.5
31. Slot depth (inches).....	$d =$		1.0
32. Tooth width, top (inches).....			0.576
33. Tooth width, average (inches).....			0.521
34. Tooth width, bottom (inches).....			0.466
35. Number of radial cooling ducts.....	$n =$	3	3
36. Width of duct (inches).....			0.4
37. Net length of armature (inches).....	$l_n =$	9.1	9
38. Net tooth section under pole (average).....		48.6	48.1
39. Apparent flux density in teeth (open circuit).....		20,500	20,700
<b>ARMATURE LOSSES AND TEMPERATURE RISE (FULL LOAD)</b>			
40. Length mean turn of armature coil (inches).....			43.3
41. Ratio of active to total copper.....			0.337
42. Resistance of one turn (ohms).....			0.00132
43. Resistance of one path through armature (ohms).....			0.0564
44. Resistance of armature (ohms).....			0.0141
45. $IE$ drop in armature (volts).....			4.7
46. $IR$ drop in series coils (main field) (volts).....		1.6	

DESIGN SHEET FOR CONTINUOUS-CURRENT GENERATOR.—Continued

	Symbols	Preliminary or assumed values	Final values
47. $IR$ drop in interpole winding.....			
48. $IR$ drop (total) at brush-contact surfaces (volts)....	.....	2	2.25
49. $I^2R$ loss in armature winding.....	.....	1,570	1,540
50. $I^2R$ loss to be radiated from armature core.....	.....	530	
51. Full-load useful flux per pole.....	$\Phi =$ .....		6,970,000
52. Flux density in armature core below teeth.....	.....		15,000
53. Full-load apparent tooth density (mean value).....	.....	22,400	
54. Radial depth of armature stampings below teeth (inches).....	$R_d =$ .....		4
55. Internal diameter of armature core (inches).....	.....		9.5
56. Weight of iron in armature core below teeth (pounds).....	.....		428
57. Weight of iron in teeth (pounds).....	.....		75
58. Iron loss in core (watts) at full load.....	.....	1,284	1,284
59. Iron loss in teeth (watts) at full load.....	.....	390	360
60. Total iron loss at full load.....	.....	1,674	1,644
61. Total watts to be radiated from armature core.....	.....	2,204	
62. Cooling surface of active belt (square inches).....	.....		675
63. Cooling surface of inner bore (square inches).....	.....		329
64. Cooling surface of ducts and ends (square inches).....	.....		1,820
65. Temperature rise of armature (degrees Centigrade).....	$T =$ .....	37	
<b>STUDY OF FLUX DISTRIBUTION IN AIR GAP</b>			
66. Permeance per slot pitch at center of pole face.....	$P_\lambda =$ .....		98
67. Equivalent air gap (inches).....	$\delta_e =$ .....		0.307
68. Drawing of pole to scale and measurement of flux paths.....	Fig. 78		
69. Permeance curve for air gap.....	Fig. 79		
70. Calculation of actual tooth densities in terms of air-gap densities, and plotting curve connecting these values.			
71. Saturation curves for air gap, teeth, and slots for a number of points on armature surface.....	Fig. 82		
72. Open-circuit m.m.f. curve.....	Fig. 83		
73. Open circuit flux distribution curve $A$ .....	Fig. 79		
74. Required area of flux curve $A$ .....	.....		106.3
75. Corrected open-circuit m.m.f. curve.....	Fig. 83		
76. Corrected flux curve $A$ to check with required area (item 74).....	Fig. 84		107
77. Maximum value of armature ampere-turns per pole (item 17).....	.....		3,565
78. Resultant m.m.f. curve to get flux curve $B$ .....	Fig. 83		
79. Flux curve $B$ . Measured area =.....	Fig. 84		99.5
80. Required area of full-load flux curve $C$ =.....	.....		115
81. Estimated additional field ampere-turns to bring up area of flux curve from area of $B$ curve to required area of $C$ curve.....	.....		900
82. M m f. curve for flux curve $C$ .....	Fig. 83		
83. Full-load flux curve $C$ .....	Fig. 84		

**PROCEDURE IN DESIGN OF D.C. GENERATOR 203**

**DESIGN SHEET FOR CONTINUOUS-CURRENT GENERATOR.—Continued**

COMMUTATOR DESIGN	Symbols	Preliminary or assumed values	Final values
84. Diameter of commutator (inches).....	$D_c =$	.....	13.5
85. Peripheral velocity (feet per minute).....	$v_c =$	.....	2,130
86. Volts per turn of armature winding (average value).....			2.87
87. Number of turns between bars.....			1
88. Total number of commutator bars.....			171
89. Bar pitch (inch).....			0.247
90. Thickness of mica insulation between bars (inch).....	$M =$	.....	0.032
91. Width of bar (on surface) (inch).....			0.215
92. Radial depth of bar (inch).....			1.75
93. Average current density over brush-contact surface (amperes per square inch).....		35	36.2
94. Contact area of brushes (all + brushes (square inches)).....		9.32	9
95. Contact area per brush set (square inches).....		4.66	4.5
96. Circumferential width of brush (inch).....	$W =$	.....	0.75
97. Brush width referred to armature surface (inch).....	$W_c =$	.....	1.083
98. Total axial brush length, per set (inch).....	$l_c =$	.....	6
99. Number of brushes per set.....			4
100. Axial length of commutator surface (inches).....	$L_c =$	7½	7½
<b>CALCULATION OF FLUX REQUIRED IN COMMUTATING ZONE</b>			
101. End flux (maxwells).....	$\Phi_e =$	.....	31,300
102. Equivalent slot flux (two slots).....	$\Phi_{e_s} =$	.....	11,730
103. Total flux entering teeth in commutating zone.....	$\Phi_c =$	.....	54,760
104. Average flux density of commutating field.....	$B_c =$	.....	712
105. Calculated density at beginning of commutation.....			586
106. Calculated density at end of commutation.....			838
107. Permissible departure from ideal values of flux density, + or - (gausses).....			1,720
<b>COMMUTATION LOSSES AND TEMPERATURE RISE</b>			
108. Brush pressure, pounds per square inch.....			1.5
109. Resistance per square inch of contact surface.....			0.025
110. Total brush resistance (full-load conditions).....			0.00556
111. Total voltage drop at brush-contact surfaces.....			2.25
112. $I^2R$ loss (watts).....		730	744
113. Friction loss (watts).....			324
114. Total commutator loss (watts).....			1,054
115. Total cooling surface (square inches).....			470.8
116. Temperature rise of commutator (degrees Centigrade).....	$T$	.....	48.4
<b>POLE CORES AND FRAME</b>			
117. Leakage coefficient (assumed).....		1.2	
118. Flux density in pole core (full load).....			16,500
119. Cross-sectional area of pole core (square inches).....			78.54
120. Pole-core width	} diameter (inches)		
121. Pole-core length (axial)			10
122. Pole length (radial) (inches).....			7
123. Flux density in frame (yoke ring).....			15,000
124. Cross-sectional area of frame (square inches).....			43.2

DESIGN SHEET FOR CONTINUOUS-CURRENT GENERATOR.—Continued

	Symbols	Preliminary or assumed values	Final values	
125. Frame width (axial) (inches).....	.....	.....	13	MM
126. Frame thickness (at center) (inches).....	.....	.....	3.5	
127. Outside diameter of frame (inches).....	.....	.....	45	
128. Calculation and plotting of saturation curve for the complete magnetic circuit.....	Fig. 87			
FIELD WINDINGS				
129. <i>SI</i> per pole for total magnetic circuit (no load)...	.....	.....	5,930	
130. <i>SI</i> per pole for total magnetic circuit (full load)...	.....	.....	7,850	
131. <i>SI</i> per pole to compensate for distortion and demagnetization.....	.....	.....	400	
132. <i>SI</i> per pole in shunt field at full load.....	.....	.....	6,200	
133. Thickness of shunt winding (inches).....	.....	2	2	
134. Length of winding space for shunt coils (inches)...	.....	5	5	
135. Size of shunt field wire (circular mils).....	.....	4,880	5,178	
136. Shunt field current (full load).....	.....	.....	4.56	
137. Number of turns per pole in shunt winding.....	.....	.....	1,360	
138. <i>SI</i> in series winding, per pole.....	.....	.....	1,650	
139. Series field current.....	.....	326	300	
140. Number of turns of series wire, per pole.....	.....	.....	5¼	
141. Size of series field wire (square inches).....	.....	0.25	.....	
142. Resistance of series field (hot).....	.....	.....	0.0028	
143. Cooling surface of field coils (one pole) (square inches).....	.....	.....	680	
144. Surface temperature rise of field coils (degrees Centigrade).....	<i>T</i>	.....	43	
145. Current in diverter.....	.....	.....	30.56	
146. Resistance of diverter.....	.....	.....	0.0275	
EFFICIENCY				
147. Corrected value for tooth loss at full load.....	.....	.....	360	
148. Calculation of efficiency at ¼, ½, ¾, 1, and 1¼ full-load output.....	.....	.....	.....	
149. Plotting of efficiency curve.....	Fig. 88			

63. Numerical Example—Calculations.—Items (6) and (7): *Number of Poles*.—Refer to table in Art. 20 (page 81). Usual number; 4 or 6. On page 78 in same article, the frequency is stated to be generally between 10 and 40. With four poles,  $f = \frac{4}{2} \times \frac{600}{60}$ , which is satisfactory.

Item (8): *Ratio of Pole Arc to Pole Pitch*.—Refer Art. 19, pages 74 and 76. Since there are no interpoles, we shall make  $r = 0.72$ .

Item (9): *Specific Loading*.—Refer Art. 19, pages 74 and 76. For 75-kw. machine, try  $q = 475$ .



*Item (10): Type of Winding.*—Refer Art. 23, page 84. In this case some doubt exists as to whether a wave or lap winding should be adopted. If the pressure were higher—say 500 volts—a series, or two-circuit, winding would be preferable. With only 220 volts to be generated, we shall adopt a simplex multiple winding which, with our four-pole machine, will give us four armature circuits in parallel.

*Item (11): Apparent Air-gap Density.*—Refer to the table on page 75 in Art. 19, and select  $B_g = 8,000$ .

*Items (12) and (13): Line Current* =  $75000/230 = 326$  amp. The current in each armature conductor will be one-quarter of this (Art. 23, page 87) if we neglect the shunt exciting current. The shunt excitation of a 75-kw. machine might amount to 2.3 per cent. (see Art. 58, page 192), so that the full-load current per conductor will be  $\frac{326}{4} (1 + 0.023) = 83.4$  amp., approximately.

*Item (14): Armature Diameter.*—Using the output formula (43) as developed in Art. 19 (page 74), we have:

$$l_a D^2 = \frac{75,000 \times 60 \times 10^8}{6.45 \times \pi^2 \times 8,000 \times 475 \times 0.72 \times 600} = 4,290$$

Referring now to page 77, we can use formula (46) to get  $l_a$  in terms of  $D$ . The ratio  $l_a/\tau$ , for an economical design of machine of this size and number of poles, will probably have a value between 0.5 and 0.8. For a square pole face,

$$\frac{l_a}{\tau} = \frac{r\tau}{\tau} = r = 0.72$$

and this seems a good proportion to aim at, especially as it will allow of cylindrical pole cores being used. With the square pole face,

$$l_a = \frac{\pi D r}{p} = 0.567 D$$

whence

$$D^3 = \frac{4,290}{0.567} = 7,560$$

and

$$D = 19.63 \text{ in.}$$

Let us therefore decide upon armature punchings of 19.5 in. external diameter.

*Item (16): Number of Inductors.*—Refer Art. 18, page 72, and Art. 19, page 74.

$$Z = \frac{\pi Dq}{I_c} = \frac{\pi \times 19.5 \times 475}{83.4} = 350 \text{ (approximately)}$$

*Item (17): Full-load Armature Ampere-turns.*—

$$(SI)_a = \frac{ZI_c}{2p} = \frac{350 \times 83.4}{2 \times 4} = 3,650$$

*Item (18): Length of Air Gap.*—Refer Art. 36, page 119.

$$\delta = \frac{3,650}{2 \times 8,000} = 0.228; \text{ or (say) } \frac{1}{4} \text{ in.}$$

*Item (19): Maxwells per Pole.*—Refer formula (38), Chap. IV, page 72.

The flux per pole on open circuit, if  $Z$  has the value as calculated for item (16), is

$$\Phi = \frac{220 \times 60 \times 4 \times 10^8}{4 \times 600 \times 350} = 6,290,000 \text{ maxwells.}$$

*Item (20): Pole Pitch.*—Refer Art. 19, page 74 and Art. 20, page 78.

$$\tau = \frac{\pi \times 19.5}{4} = 15.34 \text{ in.}$$

*Item (21): Pole Arc.*—Refer Art. 19, page 74.

$$\tau \times r = 15.34 \times 0.72 = 11.05, \text{ or (say) } 11 \text{ in.}$$

*Items (22), (23) and (24): Dimensions of Air Gap.*—

$$\frac{\Phi}{B_g} = \frac{6,290,000}{8,000} = 786 \text{ sq. cm.}$$

$$= 122 \text{ sq. in.}$$

whence  $l_a = 122 \times \frac{1}{11} = 11.1$ , and the axial length of pole face will be something less, or (say) 10.6, to avoid the large amount of flux which would otherwise curve round into the flat surface of the core discs, where it would cause eddy currents. These axial dimensions, both of armature and pole shoe, are, however, subject to correction after the actual winding details have been settled; because the practical considerations may lead to a change in the number of inductors ( $Z$ ), and a corresponding change in the amount of flux entering the armature.

*Item (25): Cross-section of Armature Conductors.*—By formula (51), page 97.

$$\Delta = \frac{500,000}{475} + \frac{3,070}{3} = 2,075$$

whence area of cross-section =  $\frac{83.4}{2,075} = 0.0402$  sq. in.

*Items (26) to (31): Conductor and Slot Dimensions.*—It is necessary to find by trial the best arrangement of slots and conductors to provide approximately 350 inductors (item (16)). The number of slots per pole should not be less than 10 (Art. 23, page 84 and Art. 26, page 93), and there must be an even number of conductors in each slot. A winding consisting of 44 or 45 slots, each with eight conductors, would be a possible arrangement; but the slot pitch would be large with so few slots. It would seem advisable to have a winding with six conductors per slot. The number of slots would then be approximately,  $350 \div 6 = 58.3$ . Either 14 or 15 slots per pole would be suitable for a parallel winding; but since it is usual to provide the armature punchings of four-pole machines with an uneven number of slots, so that the armature core can be used for a two-circuit winding, we shall adopt a winding of 57 slots with six conductors per slot, making the corrected value of  $Z = 57 \times 6 = 342$

The slot pitch (refer Art. 25, page 92), is,

$$\lambda = \frac{\pi \times 19.5}{57} = 1.076$$

The number of teeth between pole tips is,

$$\frac{15.34 - 11}{1.076} = 4.03$$

Had this figure been less than 3.5 (see Art. 26, page 93), it might have been advisable to increase the number of teeth, or widen the space between pole tips.

In order to determine the actual dimensions of the armature conductors, it will be found convenient to assume a width of slot. This should be about one-half the slot pitch, or, say, 0.5 in. (see Art. 25, page 92). If we adopt the arrangement of conductors in the slot shown in Fig. 77, the width of each conductor will be one-third of the total width available for copper. The cotton covering on each conductor would add, say, 16 mils total to its thickness; and the slot insulation will be about 0.035 in.

thick (see Art, 28, page 96). The space left for copper is therefore  $0.5 - (0.07 + 0.048) = 0.382$ ; and the width of each conductor is one-third of this amount, or 0.127. Let us make this  $\frac{1}{8}$  in. (0.125). The depth of the (rectangular) conductor will be  $\frac{0.0402}{0.125} = 0.322$ , or, say,  $\frac{5}{16}$  in. (0.312). These are the dimensions called for under item (26); and the corrected value for item (25) is  $0.312 \times 0.125 = 0.039$  sq. in.

The required slot depth is made up as follows:

Hard-wood wedge, which should be about.....	0.200 in.
Insulation above, below, and between the coils = $3 \times 0.035$ .....	0.105 in.
Cotton covering on wires (twice 0.016).....	0.032 in.
Copper.....	0.624 in.
	0.961 in.

or, say, 1 in. for the dimension  $d$  in Fig. 77.

Before finally adopting these dimensions, it will be necessary to see that the flux density in the teeth is not excessive (item (39)).

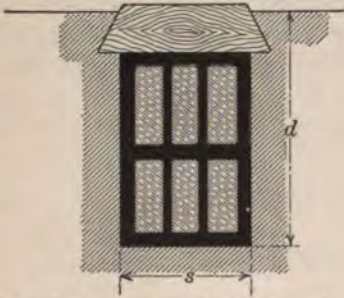

FIG. 77.—Arrangement of conductors in slot

Items (32) to (34): *Tooth Dimensions*.—The width of tooth at the top is  $t = \lambda - s = 0.576$ .

The circumference of the circle through the bottom of the slots is  $\pi \times 17.5$ ; and since the slots have parallel sides, the width of tooth at the root is  $\frac{\pi \times 17.5}{57} - 0.5 = 0.466$ .

Items (35) and (36): *Cooling Ducts*.—Refer Art. 33, page 105.

Not more than three ducts should be necessary in an armature 11 in. long. Each duct might be 0.4 in. wide.

Item (37): *Net Length of Armature*.—Refer Art. 31, page 103.

$$l_n = 0.92 (11.1 - 1.2) = 9.1 \text{ in.}$$

Item (38): *Net Cross-section of Teeth under Pole*.—The cross-section of iron in the teeth under one pole, at a point halfway up the tooth, is,

$$9.1 \times 0.521 \times \frac{57}{4} \times 0.72 = 48.6 \text{ sq. in.}$$

*Item (39): Flux Density in Teeth.*—Refer Art. 31, page 102, and Art. 32, page 104. Before calculating the flux density in the teeth, it is necessary to correct the figure for flux per pole (item (19)), because the number of face conductors ( $Z$ ) has been changed. Thus,

$$\Phi = 6,290,000 \times \frac{350}{342} = 6,430,000 \text{ maxwells.}$$

The apparent flux density at the center of the tooth, under open-circuit conditions, is therefore,

$$\frac{6,430,000}{48.6 \times 6.45} = 20,500 \text{ gaussess.}$$

Referring to the table on page 104, it will be seen that a maximum tooth density of 22,000 is permissible when the frequency is 20. We do not yet know what will be the actual flux density at the root of the teeth under full-load conditions; but it is not likely to be excessive, and we may proceed with the design.

At this stage it might be well to alter the gross length of the armature core from 11.1 to exactly 11 in., reducing the net length accordingly. This will account for the corrected values of items (37) to (39) in the last column of figures of the design sheets.

*Item (40): Length per Turn of Armature Coil.*—Referring to Art. 30, page 97, we have,

$$\sin \alpha = \frac{1.15s}{\lambda} = \frac{1.15 \times 0.5}{1.076} = 0.535$$

whence

$$\alpha = 32^\circ 20'$$

and

$$\cos \alpha = 0.845$$

By formula (52), page 98,

$$l_e = \frac{2 \times 15.34}{0.845} + 4 + 3 = 43.3 \text{ in.}$$

*Item (41): Ratio of Copper in Slots to Total Armature Copper.*—Refer Art. 34, page 109.

$$\frac{2l_a}{2l_a + l_e} = \frac{22}{22 + 43.3} = 0.337$$

*Items (42) to (45): Armature Resistance.*—Refer Art. 30, page 97. The total length of one turn of the armature winding is



65.3 in., and by formula (21) page 83, the resistance at about 60°C. will be

$$R = \frac{65.3}{0.039 \times 10^6 \times \frac{4}{\pi}} = 0.00132 \text{ ohm.}$$

There are  $Z/2$  or 171 turns in the armature winding, and therefore  $171/4 = 42.75$  turns in series in each armature circuit. The value of item (43) is therefore  $42.75 \times 0.00132 = 0.0564$  ohm; and of item (44), one-quarter of this amount, or 0.0141 ohm. The  $IR$  drop in armature winding is  $0.0564 \times 83.4 = 4.7$  volts, or 2.04 per cent. of the full-load terminal voltage. This compares favorably with the approximate figures given on page 99.

*Item (46): Pressure Drop in Series Winding.*—Refer Art. (43) page 139. We may assume this voltage drop to be one-third of 4.7 or, say, 1.6 volts.

*Item (48): Pressure Drop at Brushes.*—Refer Art. 53, page 179. Assume two volts.

*Items (49) and (50): Watts Lost in Armature Windings.*—Total  $I^2R = EI = 4.7 (83.4 \times 4) = 1,570$  watts. Item (50) is the portion of this total loss which occurs in the "active" copper of the armature; its value is,

$$1570 \times 0.337 = 530 \text{ watts,}$$

wherein the factor 0.337 is item (41) of the design sheets.

*Item (51): Flux Entering Armature at Full Load.*—Refer Art. 43, page 135.

The volts to be developed at full load are,

$$230 + 4.7 + 1.6 + 2 = 238.3$$

The full-load flux must therefore be,

$$6,430,000 \times \frac{238.3}{220} = 6,970,000 \text{ maxwells.}$$

*Items (52) to (55): Flux Density in Armature Core.*—*Internal Diameter.*—Usual flux densities for different frequencies are given in the table in Art. 32 (page 104). A density of 14,000 gaussess would be satisfactory; but since the losses in the teeth are likely to be below the average—because a 1-in. depth of slot is small for a machine of this size—a density of 15,000 may

be tried. Bearing in mind that the maximum flux in the armature core is one-half of the total flux per pole, we have,

$$R_d \times l_n \times 6.45 \times 15,000 = \frac{\Phi}{2}$$

whence

$$R_d = \frac{6,970,000}{2 \times 9 \times 6.45 \times 15,000} = 4 \text{ in.}$$

*Item (56): Weight of Iron in Core.*—The weight of a cubic inch of iron is 0.28 lb. and the total weight of iron in the core below the teeth will therefore be

$$0.28 \times 9 \times \frac{\pi}{4} [(17.5)^2 - (9.5)^2] = 428 \text{ lb.}$$

*Item (57): Weight of Iron in Teeth.*—

$$0.28 \times 1 \times 0.521 \times 9 \times 57 = 75 \text{ lb.}$$

*Items (58) to (60): Iron Losses.*—Refer Art. 31. The watts per pound are read off the curve of Fig. 34 on page 102; thus, for the armature core we have,

$$\frac{Bf}{1,000} = \frac{15,000 \times 20}{1,000} = 300$$

whence watts per pound = 3; and total watts =  $3 \times 428 = 1,284$ .

Similarly, for the teeth (item (59)) we get a loss—with full-load flux—of 390 watts. The total iron loss of 1,674 watts, being 2.23 per cent. of the output, is rather higher than the average as given in the table on page 104; but if the temperature rise is not excessive, it will not be necessary to reduce the flux densities.

*Item (61): Total Loss to be Radiated from Armature Core.*—Refer Art. 34, page 109. The copper loss to be added to the total iron loss is the amount of item (50).

*Items (62 to (64): Cooling Surfaces.*—Refer Art. 34, page 107.

$$\text{Cooling surface item (62)} = \pi \times 19.5 \times 11 = 675 \text{ sq. in.}$$

$$\text{Cooling surface item (63)} = \pi \times 9.5 \times 11 = 329 \text{ sq. in.}$$

$$\text{Cooling surface item (64)} = \frac{\pi}{2} [(19.5)^2 - (9.5)^2] \times 4 = 1,820 \text{ sq. in.}$$

*Item (65): Temperature Rise.*—Refer Art. 34, page 107. The radiating coefficient for the cylindrical surfaces is, by formula (54),

$$\text{For the outside surface } w_c = \frac{1,500 + 3,070}{100,000} = 0.0457$$

$$\text{For the inside surface } w_c = \frac{1,500 + 1,500}{100,000} = 0.03$$

In the case of the ducts, it should be noted that the radial depth of the armature stampings is large because of the wide polar pitch, and instead of taking the velocity of air through the vent ducts as one-tenth of the outside peripheral velocity, we shall assume a lower value, making  $v_d = \frac{v}{12}$ . Thus, the cooling coefficient for the ducts and ends will be, by formula (56),

$$w_d = \frac{4 \times 256}{100,000} = 0.0102$$

The procedure is exactly as followed in the example on page 111, and the temperature rise is found to be 37°C., which is within the specified limit of 40°.

*Items (66) and (67): Equivalent Air Gap.*—Refer Art. 36, page 117.

The permeance of the air gap over one slot pitch at the center of the pole face where the actual clearance is  $\delta = \frac{1}{4}$  in. may be written,

$$\begin{aligned} P_\lambda &= l_a \left[ \frac{t}{\delta} + \frac{4}{\pi} \log_e \left( \frac{\pi s}{4\delta} + 1 \right) \right] \\ &= 2.54 \times 11 \left[ \frac{0.576}{0.25} + \frac{4}{\pi} \log_e \left( \frac{\pi \times 0.5}{4 \times 0.25} + 1 \right) \right] \\ &= 98 \end{aligned}$$

and the equivalent air gap, as given by formula (58), will be

$$\begin{aligned} \delta_e &= \frac{l_a \lambda}{P_\lambda} \\ &= \frac{6.45 \times 11 \times 1.076}{98} = 0.78 \text{ cm.} \\ &= 0.307 \text{ in.} \end{aligned}$$

*Item (68): Drawing of Equivalent Flux Lines.*—Refer Art. 41, page 129.

Before completing the drawing of the pole shoe as shown in Fig. 78, it is well to estimate the cross-section of the pole core, as

PROCEDURE IN DESIGN OF D.C. GENERATOR 213

this will be helpful in deciding upon the most suitable shape of the pole shoe. The full-load flux per pole (item (51)) is 6,970,000 maxwells; and if we assume a leakage coefficient of 1.2 (Art. 56, page 187), the flux to be carried by the pole core is 8,370,000 maxwells, approximately. The density in the core may be as high as 16,000 gausses, and the cross-section is therefore  $\frac{8,370,000}{16,000 \times 6.45} = 81$  sq. in. If the pole core is made of circular cross-section,

$$\begin{aligned} \text{Diameter} &= \sqrt{81 \times \frac{4}{\pi}} = 10.15 \\ &= (\text{say}) 10 \text{ in.} \end{aligned}$$

A laminated pole shoe of the shape shown in Fig. 78 will be suitable. The stampings would be riveted together and at-

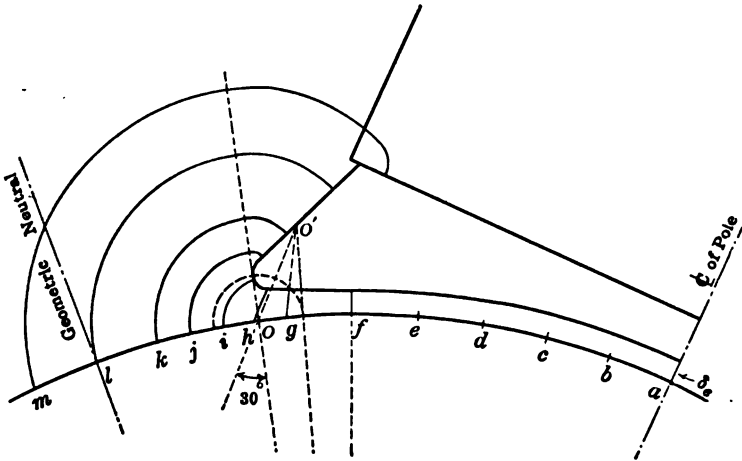

FIG. 78.—Graphical construction for calculating permeance of flux paths.

tached by screws to the face of the cylindrical pole core. The distance  $aO$ , measured on the armature surface, is one-half of item (21), or 5.5 in.; while  $al$  is one-half of the pole pitch  $\tau$  (item (20)), and measures 7.67 in. The tip of the pole is shaped so that the air gap increases from the point  $f$  outward, being  $\frac{1}{8}$  in. greater at the ends of the pole arc than at the center. The extreme point of the pole shoe is rounded off with a  $\frac{3}{16}$ -in. radius. The reference points on the armature surface have been chosen for convenience at intervals of  $10^\circ$ , except in the neighborhood of the pole tip, where the selected points are only  $5^\circ$  apart.

The construction of the flux lines is as explained in Art. 41, and the measurements taken off the drawing have the following values:

Points on armature	Length of equivalent flux line = $l$ cm.	Permeance per square centimeter = $1/l$
<i>a, b, c, d, e, f</i>	0.78	1.28
<i>g</i>	0.93	1.075
<i>h</i>	1.17	0.855
<i>i</i>	2.03	0.492
<i>j</i>	4.13	0.242
<i>k</i>	7.12	0.141
<i>l</i>	13.1	0.076
<i>m</i>	20.1	0.05

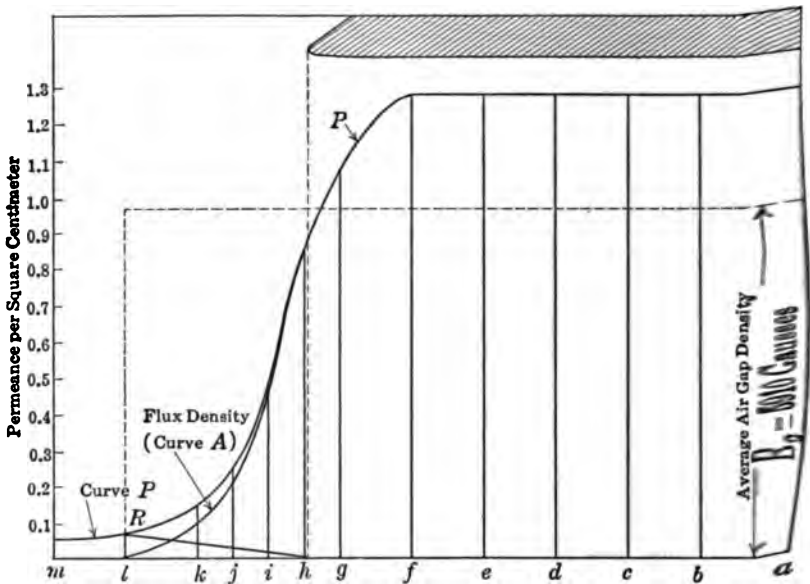

FIG. 79.—Curves of air gap permeance and open circuit flux distribution.

*Item (69): Permeance Curve.*—Refer Art. 39. The curve marked *P* in Fig. 79 has been plotted from the above figures. It shows the variation of air-gap permeance between pole and armature at all points from the center of pole face to a point, *m*,  $10^\circ$  beyond the geometric neutral.

*Item (70): Actual Tooth Densities.*—Refer Art. 37, page 119. In order to make use of formula (62), giving the relation between



$B_s$  and  $B_t$  at high densities, it will be found convenient to prepare a table similar to the one below.

$B_t$	$H_t$	$\mu$	$\frac{d + \mu \delta}{\mu(d + \delta)}$	$B_s$
21,000	450	46.7	0.217	10,360
22,000	670	33.0	0.224	10,950
23,000	950	24.2	0.233	11,600
24,000	1,360	17.6	0.245	12,300
25,000	2,000	12.5	0.264	13,100

Values of the actual tooth density,  $B_t$ , from 21,000 to, say, 25,000 gausses are assumed, and the corresponding values of  $H$

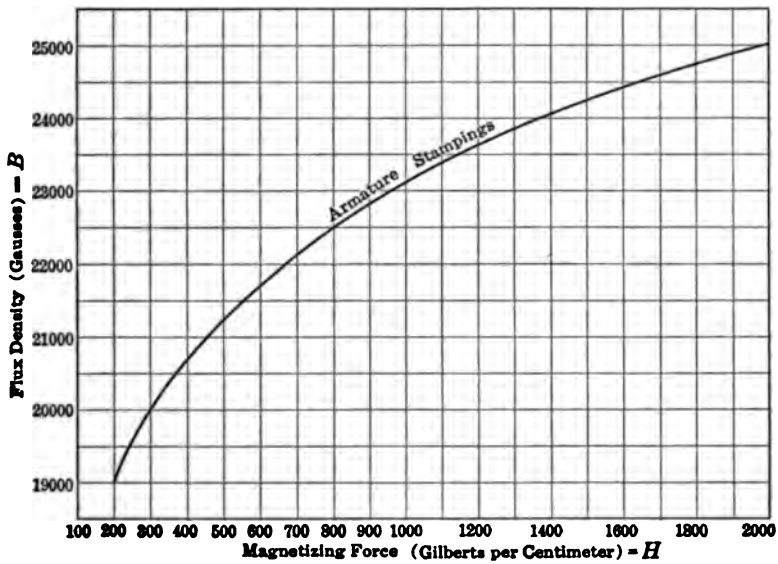

FIG. 80.—B-H Curve for armature stampings—high values of magnetization.

and  $\mu$  are then found by referring to the  $B$ - $H$  curve, Fig. 80, which is similar to Fig. 4 except that the quantities concerned are expressed as  $B$  and  $H$  because this is more convenient for obtaining  $\mu$ .

The quantity which is a function of  $\mu$ , in formula (62), can now be determined, and the corresponding values of  $B_s$  readily calculated.

In this example, we shall consider the tooth density in the

root, or narrowest part, of the tooth; and  $t$  in the formula is therefore taken as 0.466 in. (item 34). The results of this calculation are shown graphically in the upper dotted curve of Fig. 81.

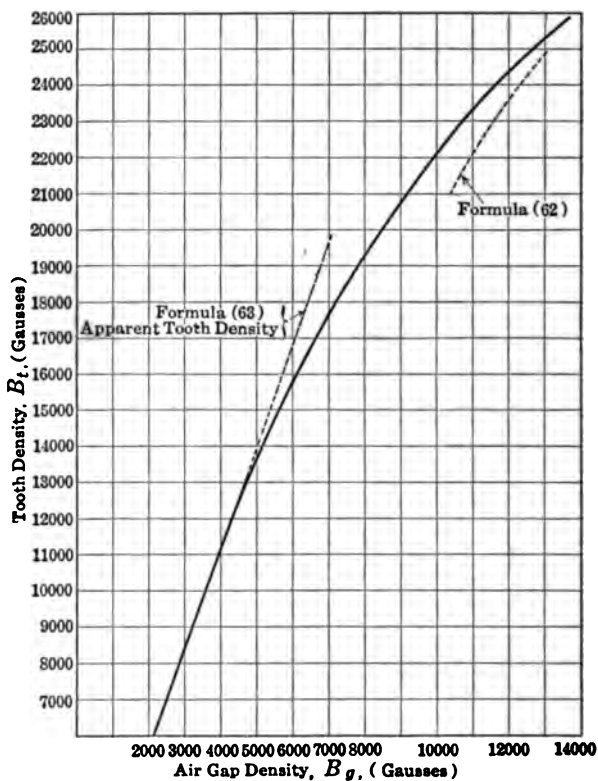

FIG. 81.—Curve giving relation between air gap and tooth densities.

The “apparent” tooth density at the bottom of the tooth is, by formula (63),

$$B_t = B_g \left( \frac{1.076 \times 11}{0.466 \times 9} \right) = 2.82B_g$$

which enables us to plot the lower dotted curve of Fig. 81. The actual density in the iron of the teeth is almost exactly expressed, for the low values, by formula (63); while at very high densities, the actual tooth density approaches more and more nearly the values calculated by formula (62) without ever quite reaching them. It is therefore possible to draw a curve, such as the full

line in Fig. 81, which very closely expresses the true relation between the tooth density and the average density over the slot pitch, for the entire range of values from zero to the highest attainable.

*Item (71): Saturation Curves for Air Gap, Teeth, and Slots.*—Refer Art. 38, page 121, and Art. 42, page 132. We are now in a position to plot curves similar to those of Fig. 49, page 133; and, in order to obtain a proper value for the ampere-turns necessary to overcome the reluctance of the teeth, the correction for the taper of teeth should be applied. The results of the calculations for the teeth are shown in tabular form; the meaning of the different columns of figures being as follows:

*First column:* Assumed values of air-gap density  $B_g$ , including the highest value likely to be attained.

*Second column:* The corresponding values of the density  $B_t$  at the bottom of the tooth (read off the full-line curve of Fig. 81).

*Third column:* The magnetizing force  $H$ , calculated, when necessary, by applying SIMPSON'S rule (Formula 64), as explained in Art. 38.

*Fourth column:* The ampere-turns required to overcome the reluctance of the teeth, being

$$(SI)_t = \frac{Hd_e \times 2.54}{0.4\pi}$$

where  $d_e$  is the "equivalent" length of tooth; its numerical value, in this example, being  $(1 + 0.25) - 0.307 = 0.943$  in.

$B_g$	$B_t$	$H$	$(SI)_t$
12,000	24,400	790	1,500
10,000	22,100	347	642
8,000	19,300	110	210
6,000	15,800	20	38

As an example of the method of calculation, consider the value  $B_g = 10,000$ ; the corresponding value of tooth density, as read off Fig. 81, is  $B_t = 22,100$ . This is the actual density at the root of the tooth. Referring to items (32) and (34), it is seen that, over a distance of 1 in., the width of tooth changes by the amount  $0.576 - 0.466 = 0.11$  in. The width of tooth at the distance  $d_e$  from the bottom of tooth (see Fig. 38) is therefore

$0.466 + (0.11 \times 0.943) = 0.57$ ; and the density at this point is

$$B_w = 22,100 \times \frac{0.466}{0.57} = 18,100$$

At the halfway section,  $B_m = \frac{22,100 + 18,100}{2} = 20,100$

The corresponding values of  $H$ , as read off the  $B$ - $H$  curves, Fig. 80 and Fig. 2, are:

At bottom,  $H_n = 700$

At middle,  $H_m = 310$

At top,  $H_w = 144$ .

By formula (64), we have,

$$\text{Average } H = \frac{700}{6} + \frac{2 \times 310}{3} + \frac{144}{6} = 347$$

which is appreciably higher than the value of  $H$  at the section halfway between the two extremes. This difference will, however, hardly be noticeable on low values of tooth density; and indeed the somewhat tedious work involved in the above calculation is quite unnecessary with small values of tooth density, because the ampere-turns required to overcome tooth reluctance are then, in any case, but a small percentage of the air-gap ampere-turns. The values of  $H$ , in the above table, for  $B_g = 8,000$  and  $B_g = 6,000$ , are those corresponding to the average values of the tooth density ( $B_m$ ).

Having plotted in Fig. 82 the curve for the teeth only, the straight line for the air-gap proper can now be drawn for the points under the center of the pole face where the equivalent air gap is  $\delta_e = 0.307$  in. Obviously, since  $Hl = 0.4\pi SI$ , and  $B$  has the same value as  $H$  in air, we may write,

$$\begin{aligned} (SI)_g &= B_g \left( \frac{0.307 \times 2.54}{0.4\pi} \right) \\ &= 0.62B_g \end{aligned}$$

This gives us the line marked  $A$  in Fig. 82. The addition to this curve of the ampere-turns for the teeth and slots, results in the curve marked  $a, b, c, d, e, f$ , which may be used for all points under the pole where the permeance has the same value as at  $a$ . The curves for the other points on the armature surface may now be drawn as explained in Art. 42.

*Items (72) to (76): Flux Distribution on Open Circuit.*—Refer Arts. 40, 41, and 42. From the point  $R$  on the permeance curve

PROCEDURE IN DESIGN OF D.C. GENERATOR 21

(Fig. 79) draw a straight line to the point on the datum line immediately below the pole tip, in order to obtain the curve of flux distribution on open circuit, all as explained on page 131 (Art. 41). Measure the area of this flux curve, and draw

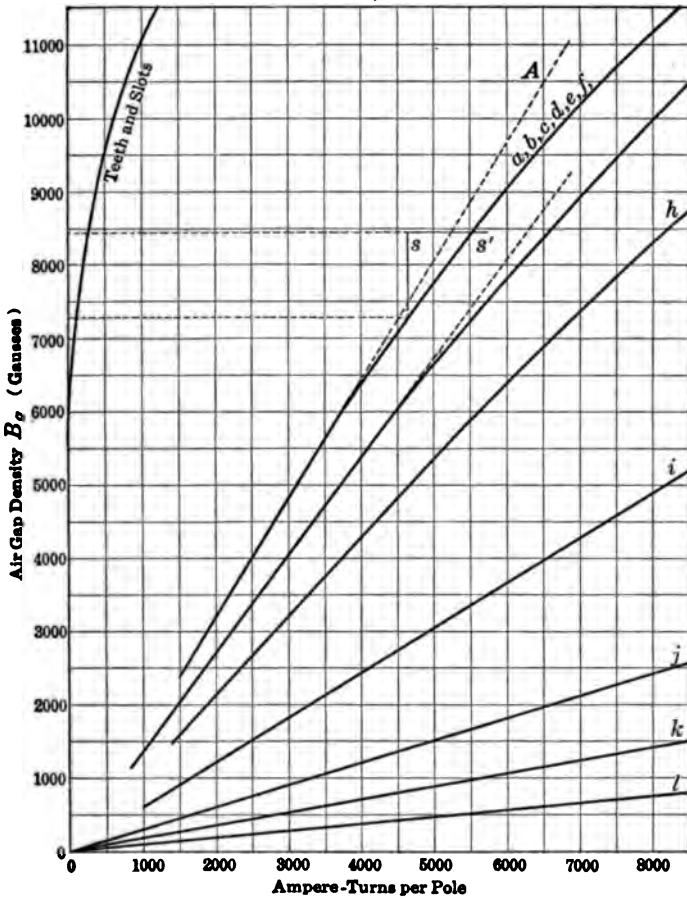

FIG. 82.—Saturation curves for air-gap, teeth, and slots.

the dotted rectangle of equal area. The height of this rectangle represents the average air-gap density over the pole pitch, and its numerical value is  $B_g$  (average) =  $\frac{6,430,000}{6.45 \times 15.34 \times 11}$  = 5,910 gauss.

Using this length as a scale for measuring other ordinates of the



flux curve, the value of  $B_p$  at all points on the armature periphery can be determined.

The ampere-turns between pole and armature, due to field excitation on open circuit, have at every point on the armature surface the value  $SI = \frac{B_p}{0.4\pi \times \text{permeance per square centimeter}}$ .

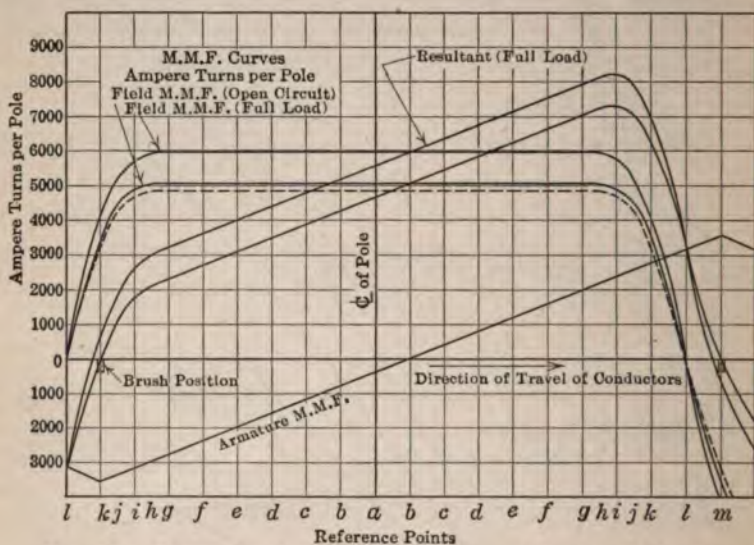

FIG. 83.—Curves showing distribution of m.m.f. between pole and armature.

The actual figures are given in the following table.

Point on armature surface	$P_{sq. cm.}$	$B_p$	$SI$
$a, b, c, d, e, f,$	1.28	7,840	4,860
$g$	1.075	6,580	4,860
$h$	0.855	5,220	4,850
$i$	0.492	2,910	4,700
$j$	0.242	1,305	4,275
$k$	0.141	581	3,270
$l$	0.076	0	0

From these figures the dotted m.m.f. curve of Fig. 83 has been plotted. Observe now that the m.m.f. represented by 4,860 ampere-turns per pole is not sufficient to overcome the reluctance of the teeth, and in order to obtain the required total flux on

open circuit, the m.m.f. between pole face and armature core, (*i.e.*, bottom of slots) must exceed this value. Referring again to Fig. 82, it will be seen that, for a density of 7,840 gaussses under the pole face, the m.m.f. to overcome tooth reluctance amounts to a little over 200 ampere-turns. The ordinates of the dotted m.m.f. curve of Fig. 83 may therefore be increased throughout in the proper proportion, the maximum addition being 200 ampere-turns. This corrected curve may now be used to plot—with the aid of the magnetization curves of Fig. 82—the actual distribution of flux over the armature surface, when the effect

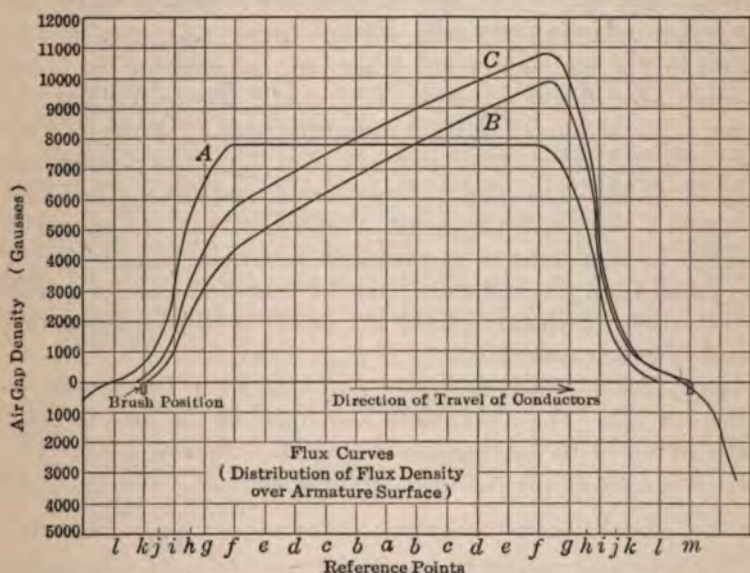

FIG. 84.—Curves of flux distribution over armature surface.

of tooth saturation is taken into account. This has been done in Fig. 84, where the curve marked *A* is similar to the flux curve of Fig. 79 except in so far as its shape may be modified by tooth saturation.

The procedure above described for obtaining the actual flux distribution curve is logical and correct; but for practical purposes it is usually permissible to assume that the curve *A* of Fig. 79 shows the actual flux distribution, the slight modification brought about by variable degrees of tooth saturation being neglected. It is then a simple matter to plot the required open circuit field m.m.f. curve directly by taking from Fig. 82 the



values of  $SI$  corresponding to each known value of the air-gap density,  $B_g$ .

The average ordinate of the curve  $A$  in Fig. 84—as obtained by dividing the area under the curve by the length of the base—is found to check within 1 per cent. of the required amount (average  $B_g = 5,910$  gausses). Had there been an appreciable difference between the calculated and measured areas of the flux curve, it would have been necessary to correct the m.m.f. curve of Fig. 83, and re-plot the flux curve  $A$  of Fig. 84.

*Items (78) and (79): Flux Distribution under Load.*—Refer Art. 43, page 137. The curve of armature m.m.f., of which the maximum value is 3,565 ampere-turns (item (17)), may now be drawn in Fig. 83. The point  $k$  has been selected for the brush position because the (positive) field m.m.f. has here about the same value as the (negative) armature m.m.f. From the resultant m.m.f. curve, the flux curve  $B$  of Fig. 84 is plotted, the area of which—measured between brush and brush—is found to be 99.5 sq. cm. while curve  $A$  measures 107 sq. cm. The average air-gap density is therefore less than before current was taken from the armature, and the loss of flux is due partly to distortion (tooth saturation) and partly to the demagnetizing ampere-turns (brush shift).

*Items (80) to (83): Corrected Full-load Flux Distribution.*—Refer Art. 43. The e.m.f. to be developed at full load is 238.3 volts, obtained by adding the numerical values of items (45), (46), and (48), to the full-load terminal voltage. The final flux curve  $C$  should therefore have an area of  $\frac{106.3 \times 238.3}{220} = 115$  sq. cm.; the number 106.3 being item (74). In order to estimate the probable increase in field excitation to obtain this increase of flux, we may follow the method outlined on page 138. The ampere-turns necessary to bring up the flux from the reduced value under curve  $B$  to the original value under curve  $A$ , are calculated by assuming that the air-gap density under the pole has changed from 7,800 gausses to  $7,800 \times \frac{99.5}{107} = 7,260$  gausses; and the ampere-turns necessary to increase the developed volts from 220 to 238.3 are calculated by assuming that the air-gap density under the pole must be raised from 7,800 to  $7,800 \times \frac{238.3}{220} = 8,450$  gausses. The total additional excitation is indicated by the distance  $SS'$  in Fig. 82, its value being about 900

**PROCEDURE IN DESIGN OF D.C. GENERATOR 223**

ampere-turns. This must be added to the open-circuit m.m.f. curve of Fig. 83, all the ordinates of which must be increased in the ratio  $\frac{5,050 + 900}{5,050}$ . The new resultant m.m.f. curve—obtained by adding this full-load field m.m.f. to the armature m.m.f.—may now be used to plot the final full-load flux curve **C** of Fig. 84.

*Items (84) and (85): Diameter of Commutator.*—Refer Art. 53, page 181.

A diameter of commutator not exceeding three-quarters of the armature diameter will be suitable. Let us try a diameter  $D_c = 13.5$  in., making  $v_c = 3,070 \times \frac{13.5}{19.5} = 2,130$  ft. per minute. This dimension is subject to correction if the thickness of the individual bar does not work out satisfactorily.

*Items (86) to (88): Number of Commutator Bars.*—Refer Art. 27, page 93. On a 220-volt machine, the potential difference between adjacent commutator segments might be anything between 2.5 and 10 volts (page 94). If we provide the same number of commutator bars as there are slots on the armature, the average voltage between the segments at full load would be about  $\frac{230 \times 4}{57} = 8.63$ , which is within the limits obtained in practice. At the same time commutation will be very much improved by having a smaller number of turns between the tappings, and since the number of inductors in each slot is not divisible by 4, we shall have to provide  $57 \times 3 = 171$  commutator segments.

*Items (93) to (99): Dimensions of Brushes.*—Unless a very soft quality of carbon is used, the current density over brush-contact surface does not usually exceed 40 amp. per square inch. Taking 35 as a suitable value, the contact surface of all brushes of the same sign will be  $\frac{326}{35} = 9.32$  sq. in., or 4.66 sq. in. per brush set. If the brush covers three bars, the width will be  $W = 0.247 \times 3 = 0.741$  in. Let us make this dimension  $\frac{3}{4}$  in. The total length of brushes per set, measured in a direction parallel to the axis of the machine, will then be  $l_c = 4.66 \div 0.75 = 6.23$ , or (say) 6 in., which can be made up of six brushes each 1 in. by  $\frac{3}{4}$  in.

*Item (100): Length of Commutator.*—The spaces between brushes (which will depend upon the type of brush holder) and the

clearances at the ends, including an allowance for "staggering" the brushes, will probably require a minimum axial length of commutator surface of  $7\frac{1}{2}$  in.

*Item (101): Flux Cut by End Connections.*—Refer Art. 48. Assuming for the constant in formula (72) on page 159, the average value  $k = 2.4$ , we have:

$$\Phi_e = 0.4 \sqrt{2} \times 2.4 \times 3 \times 83.4 \times \frac{57}{4} \times 2.75 \left[ \left( \log_e \frac{57}{2} \right) - 1 \right] \\ = 31,300 \text{ maxwells.}$$

*Item (102): Slot Flux.*—Refer Art. 49. The equivalent slot flux, by formula (80), page 164, is

$$\Phi'_{es} = \frac{1.6 \times \pi \times 1 \times 3 \times 83.4 \times 11 \times 2.54}{6 \times 0.5} = 11,730 \text{ maxwells.}$$

*Items (103) and (104): Average Flux Density in Commutating Zone.*—Refer Art. 49. By formula (81) page 164:

$\Phi_c = (2 \times 11,730) + 31,300 = 54,760$  maxwells. The average density is, therefore, by formula (83):

$$B_c = \frac{54,760}{1.083 \times 11 \times 6.46} = 712 \text{ gaussess.}$$

*Items (105) and (106): Flux Densities at Beginning and End of Commutation.*—The value of item (104) is the density of the magnetic field at the middle of the zone of commutation. After the current in the short-circuited coil has passed through zero value (a condition attained only when the coil as a whole is moving in a neutral field), the field should increase in strength until, at the end of commutation, it is of such a value as to develop  $I_c R$  volts in the short-circuited coil. The resistance,  $R$ , of the coil of one turn is 0.00132 ohm (item (42)), and the e.m.f. to be developed in the coil at the beginning and end of commutation is therefore  $0.00132 \times 83.4 = 0.11$  volt, or 0.055 volt in each coil-side. The flux to be cut by each coil-side to develop this voltage is:

$$\begin{aligned} \text{Maxwells per centimeter} &= \frac{\text{volts} \times 10^8}{\text{rate of cutting, in centimeters per second}} \\ \text{of armature periphery} &= \frac{0.055 \times 10^8 \times 60}{3,070 \times 12 \times 2.54} \\ &= 3,530 \end{aligned}$$



and this corresponds to a density of  $\frac{3,530}{11 \times 2.54} = 126$  gausses. The ideal flux density at beginning of commutation is therefore  $712 - 126 = 586$  gausses, and at the end of commutation,  $712 + 126 = 838$  gausses.

Item (107): *Sparking Limits of Flux Density in Zone of Commutation.*—Refer Art. 52. The time of commutation, in seconds,

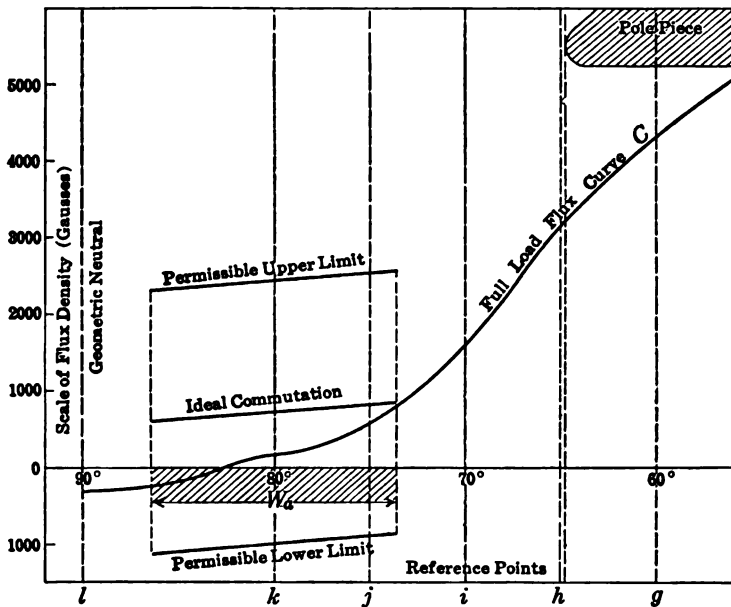

FIG. 85.—Flux distribution in zone of commutation.

is approximately  $t_c = \frac{W}{V_c} = \frac{0.75 \times 60}{2,130 \times 12} = 0.00176$  sec.; and, by formula (88) page 177;

$$\begin{aligned} \Phi &= \frac{3}{4} \times 0.00176 \times 10^8 \\ &= 132,000 \text{ maxwells.} \end{aligned}$$

The variation in flux density which is permissible when carbon brushes of medium hardness are used, will therefore be

$$\frac{132,000}{1.083 \times 11 \times 6.45} = 1,720 \text{ gausses.}$$

A portion of the full-load flux curve C of Fig. 84 has been re-drawn in Fig. 85 to a larger scale, and the flux density required

to obtain ideal commutation, together with the permissible variation from this value, are indicated on the same diagram. It will be seen that there should be no difficulty in obtaining sparkless commutation at full load with the brushes in the selected position (over the point  $k$ ); but the brush might be moved with advantage  $4^\circ$  or  $5^\circ$  nearer to the leading pole tip; and, although the final flux curve  $C$  would be slightly modified, it would not depart materially from the line drawn in Fig. 85. The angular degrees referred to are so-called "electrical" degrees, because the pole pitch has been divided into 180 parts; the displacement referred to therefore corresponds, in a four-pole machine, to a movement of 2 to  $2\frac{1}{2}$  actual space degrees.

In connection with Fig. 85, it should be observed that it is only in the case of a full-pitch winding that both coil-sides will be moving through a field of the same density at the same instant of time. In the design under consideration the pole pitch is equal to  $11\frac{1}{4}$  times the slot pitch, while the two sides of the coil would probably be spaced exactly 11 slot pitches apart. This is very little short of a full-pitch winding, and the flux cut by the two sides of the coil is very nearly the same at any given instant; but the method illustrated by Fig. 85 can, of course, be used for determining the proper brush position with short-pitch as well as with full-pitch windings.

*Item (108): Brush Pressure.*—Refer Arts. 53 and 54. Assume  $1\frac{1}{2}$  lb. per square inch.

*Items (109) to (112): Brush Resistance and Losses.*—Refer Arts. 53 and 54. From Fig. 68 (page 179) we find the surface resistance of hard carbon brushes to be about 0.025 ohms per square inch for a current density of 36.2 (item (93)). The area of all brushes of the same sign is 9 sq. in. (item (94)); and the total brush resistance is therefore

$$\frac{0.025 \times 2}{9} = 0.00556 \text{ ohm.}$$

The calculated  $IR$  drop is  $0.00556 \times 326 = 1.81$  volts, which should be increased by about 25 per cent. as suggested on page 181, making this item 2.25 volts. The  $I^2R$  loss is  $326 \times 2.25 = 730$  watts. In these, and some previous, calculations, the value of the line current (item (12)) has been used in place of the total current passing through the armature windings. It is true that an allowance should have been made for the shunt exciting

current; but this is usually an unnecessary refinement; and when calculating brush losses, great accuracy in results is not attainable because the resistance at the brush-contact surface is always a quantity of rather doubtful value.

*Item (113): Brush-friction Loss.*—Refer Art. 54. Assuming a coefficient of friction of 0.25, the brush-friction loss by formula (89) is

$$W_f = \frac{0.25 \times 1.5 \times 18 \times 600 \times 13.5 \times \pi \times 746}{12 \times 33,000} = 324 \text{ watts.}$$

*Items (115) and (116): Cooling Surface and Temperature Rise of Commutator.*—Refer Art. 54 and Fig. 70, page 183. The radial height of the risers will be about 2 in., making  $D_r = 17\frac{1}{2}$  in. The radial depth of the exposed ends of the copper bars might amount to  $\frac{3}{4}$  in., making  $D_e = 12$  in.; and the total cooling surface considered, worked out as explained on page 182, amounts to 492 sq. in.

The radiating coefficient, as given in formula (90), is

$$0.025 + \frac{2,130}{100,000} = 0.0463,$$

whence  $T = \frac{1,054}{492 \times 0.0463} = 46.3^\circ\text{C.}$ , which is permissible.

Had this calculated temperature rise exceeded  $50^\circ$ , it might have been necessary to increase the axial length of the commutator, or reduce the losses by using a soft quality of carbon brush and perhaps a lighter pressure at the contact surface. In some cases special ventilating ducts are provided inside the commutator; but these should not be necessary in a machine of the type and size considered.

*Item (117): Leakage Coefficient.*—Refer Art. 56, page 186. The value of this item was estimated at 1.2 in connection with the shaping of the pole shoe (item (68)).

*Items (118) to (121): Flux Density in Pole Core.*—A cylindrical pole core 10 in. in diameter has been decided upon (item (68)). The area of cross-section is therefore 78.54 sq. in., and the full-load flux density in the pole core near the yoke ring is

$$\frac{6,970,000 \times 1.2}{78.54 \times 6.45} = 16,500 \text{ gaussess.}$$

*Item (122): Radial Length of Pole.*—Refer Art. 55, page 186. The full-load ampere-turns per pole for air gap, teeth and slots amount to about 6,000 (see Fig. 83). Then, by formula (91),

the length of winding space should be  $c = \frac{6,000}{875} = 6.85$  in.

Let us make the cylindrical pole core 7 in. long, which will determine the inside diameter of the yoke ring. This will have to be about 38 in. as shown in Fig. 86.

*Items (123) to (127): Dimensions of Yoke Ring.*—Assuming a density of 15,000 gausses in the cast-steel yoke ring, the cross-section will be

$$\frac{6,970,000 \times 1.2}{2 \times 15,000 \times 6.45} = 43.2 \text{ sq. in.}$$

The dimensions can now be determined, and the lengths of the flux paths obtained from Fig. 86.

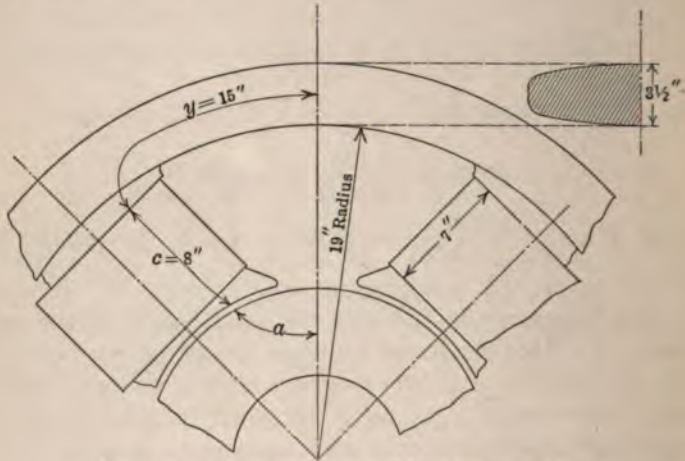

FIG. 86.—Magnetic circuit of four-pole dynamo.

*Item (128): Open-circuit Saturation Curve.*—Refer Chap. IX, Arts. 55, 56, and 57. Also Art. 16 of Chap. III. The calculations of the total ampere-turns on each pole of the machine, to develop on open circuit a given voltage, are shown in the accompanying table. Suitable values of terminal voltage are selected to obtain points on the saturation curve. One of the values should be slightly higher than the developed e.m.f. under full-load conditions. It is not necessary to make the calculations for very low voltages because the reluctance of the iron parts of the magnetic circuit is then negligible. For each selected value of the developed e.m.f., the ampere-turns for the complete magnetic circuit are calculated exactly as explained in

**PROCEDURE IN DESIGN OF D.C. GENERATOR 229**

Chap. III, Art. 16, in connection with the horseshoe lifting magnet. The useful flux entering the armature must be multiplied by the leakage factor to obtain the total flux in the yoke ring; and, in the case of the pole cores, the approximation suggested in Art. 16 (page 60) may be used. The average value of the pole-core density, for use in calculating the ampere-turns required, is

$$B_c = \frac{2B_y + B_p}{3}$$

In this instance  $B_y = 1.2B_p$ ; whence  $B_c = 1.133B_p$ , the meaning of which is that the density in the pole core is calculated on the assumption that the leakage factor is 1.133 instead of 1.2, as used for estimating the flux in the frame.

**OPEN-CIRCUIT SATURATION**  
(Table for Calculating Ampere-turns per Pole for Total Magnetic Circuit)

	245	230	210	190
No-load voltage.....				
Flux entering armature per pole (maxwells).....	7,160,000	6,725,000	6,140,000	5,560,000
Flux density (lines per square inch)	99,400	93,400	85,250	77,250
Armature core (36 sq. in.).....				
Air gap (maximum value).....	56,100	52,600	48,000	43,400
Pole core (78.54 sq. in.).....	103,400	97,100	88,700	80,300
Yoke ring (43.2 sq. in.).....	99,400	93,400	85,250	77,250
Ampere-turns per inch	80	42	20	11
Armature.....				
Pole core.....	104	64	26	14
Yoke.....	80	42	20	11
Total ampere- turns	408	214	102	56
Armature ( $a = 5.1$ ).....				
Pole core ( $c = 8$ ).....	832	512	208	112
Yoke ( $y = 15$ ).....	1,200	630	300	165
Air gap and teeth.....	5,750	5,300	4,800	4,250
Total ampere-turns.....	8,190	6,656	5,410	4,583



The ampere-turns per inch are read off the upper curve of Fig. 3 (page 17), and the lengths of the various parts of the magnetic circuit are taken from Fig. 86. The length of the iron path in the armature core is taken as one-third of the pole pitch, as suggested in Art. 57. The ampere-turns for the air gap, teeth and slots are read directly off the curve *a, b, c, d, e, f*, of Fig. 82 (page 219), for the density corresponding to the maximum value of the flux curve *A* of Fig. 84. It is assumed that

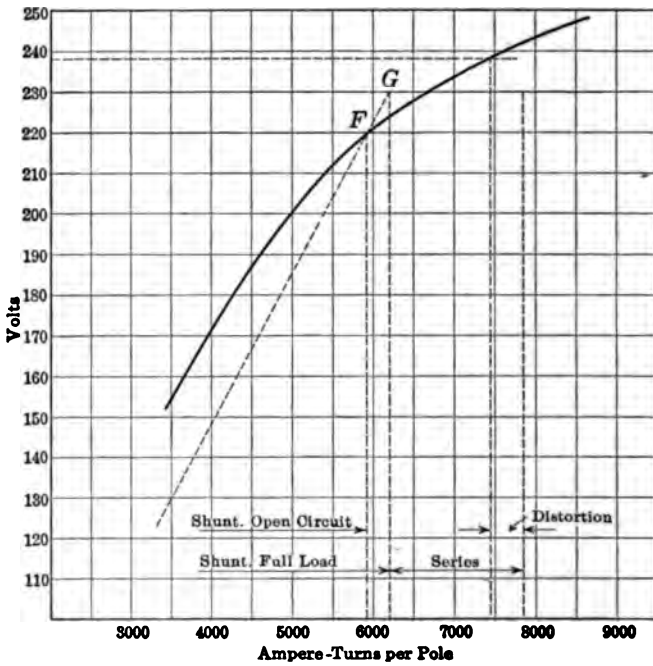

FIG. 87.—Open-circuit saturation curve (numerical example).

the shape of this curve remains unaltered, and that the maximum ordinate is directly proportional to the developed voltage.

The curve, Fig. 87, is plotted from the results of these calculations. It shows the connection between developed e.m.f. (or open-circuit terminal voltage) and the corresponding ampere-turns of excitation per pole. The shunt ampere-turns on open circuit are 5,930, and at full load,  $5,930 \times \frac{230}{220} = 6,200$ . The ampere-turns in the series winding are  $7,850 - 6,200 = 1,650$ , which includes the ampere-turns to compensate for armature

demagnetization and distortion. This correction, amounting to 400 ampere-turns, is obtained from Fig. 82, where this number of ampere-turns is seen to be necessary to raise the flux density under the center of the pole from 7,260 to 7,800 gausses, as explained on page 222.

*Items (133) to (137): Shunt Field Winding.*—Refer Art. 58, Chap. IX, and Art. 10, Chap. II. The length of winding space for the shunt may be determined by dividing the total length available for the windings in the proportion of the ampere-turns in shunt and series coils respectively. The length of the cylindrical core is 7 in., and  $7 \times \frac{6,200}{7,850} = 5.53$ . Some allowance should be made for external insulation, and the net length of winding space for the shunt coils might be, say, 5 in. Let us assume the total thickness of winding to be 2 in. The inside diameter of the winding might be  $10\frac{1}{4}$  in., making the average diameter  $12\frac{1}{4}$  in., and the mean length per turn, 38.5 in. We shall suppose that the shunt rheostat absorbs 15 per cent. of the voltage on open circuit; which leaves 187 volts across the shunt winding. By formula (26) on page 42, we have:

$$(m) = \frac{38.5 \times 5,930 \times 4}{187} = 4,880$$

Referring to the wire table on page 34, the standard size of wire of cross-section nearest to this calculated value is No. 13 B. & S. gage. This can be used if the rheostat is arranged to reduce the voltage across the winding in the proper proportion. The number of turns per inch is 11.8, from which it is seen that 1,360 turns can be wound in the space available.

The resistance of all the four coils in series is

$$\frac{38.5 \times 1,360 \times 4 \times 2.328}{12 \times 1,000} = 40.5 \text{ ohms, at } 60^\circ\text{C.}$$

The current, under open-circuit conditions, is  $\frac{5,930}{1,360} = 4.36$  amp., and at full load (item (136)) it is  $4.36 \times \frac{230}{220} = 4.56$  amp. This is only 1.4 per cent. of the line current; a low value, which might perhaps be increased in order to reduce the amount of copper in the field coils if the temperature rise is not excessive.

*Items (139) to (142): Series Field Coils.*—Refer Art. 58, page 192. The series turns may be placed at either end of the pole,

preferably near the pole shoe. The space available in a radial direction is about  $7 - 5\frac{1}{2} = 1\frac{1}{2}$  in. The number of turns per pole is  $\frac{1,650}{326} = 5.06$ . Let us put  $5\frac{1}{2}$  turns on each pole, and make the final adjustment by means of a diverter. The current through the series winding will therefore be  $\frac{1,650}{5.5} = 300$  amp.

The total depth of winding might be about the same as for the shunt coils, *i.e.*, 2 in. The mean length per turn would then be 38.5 in., and the total length,  $4 \times 5.5 \times 38.5 = 847$  or, with an allowance for connections, say, 890 in. Assuming a current density of 1,200 amp. per square inch, the cross-section would be  $\frac{300}{1,200} = 0.25$  sq. in. This winding may consist of flat copper strip wound on edge, or of any other shape of conductor of this cross-section. If preferred, two or more conductors of some stock size can be connected in parallel to make up a total cross-section of about 0.25 sq. in. The space available is more than sufficient, and we shall assume for the present that the cross-section is exactly 0.25 sq. in., or 318,000 circular mils. The resistance, at 60°C., will then be  $\frac{890}{318,000} = 0.0028$  ohm. The drop in volts in the series winding is therefore  $0.0028 \times 300 = 0.84$ , which, being very small, may be increased if it is found that the temperature rise is appreciably below the specified limit.

*Items (143) and (144): Temperature Rise of Field Coils.*—Refer Art. 59, Chap. IX. The area of the two cylindrical surfaces is approximately  $7 \times \pi(10 + 14) = 528$  sq. in. The area of the two ends is  $2 \times \frac{\pi}{4}(14^2 - 10^2) = 151$  sq. in. The total cooling surface of all the field windings is therefore  $679 \times 4 = 2,720$  sq. in., approximately.

The  $I^2R$  loss at full load in the shunt winding is  $(4.56)^2 \times 38.4 = 800$  watts; and the  $I^2R$  loss in the series coils is  $(300)^2 \times 0.0028 = 252$  watts, making a total loss of 1,052 watts.

The cooling coefficient, as given by curve A of Fig. 76 (page 194), is 0.009, and the temperature rise will therefore be

$$T = \frac{1,052}{0.009 \times 2,720} = 43^\circ\text{C.}$$

This is a little higher than the specified limit of 40°, and if the cooling coefficient could be relied upon for the accurate prede-

termination of the temperature rise, it would be necessary either to increase the weight of copper in the coils, or to sectionalize the windings so as to improve the ventilation. The latter course would be the right one in this case since the copper loss is not by any means excessive, and it would be desirable to reduce rather than increase the amount of copper in the field windings.

*Items (145) and (146): Resistance of Diverter.*—Assuming the “long shunt” connection, the series current passing through the diverter will be 30.56 amp., and the resistance of the diverter must therefore be

$$0.0028 \times \frac{300}{30.56} = 0.0275 \text{ ohm.}$$

A resistance slightly greater than this should be provided, of a material and cross-section capable of carrying at least 40 amp. without undue heating. The final adjustment can then be made when the machine is on the test floor.

*Item (147): New Calculation of Losses in Teeth.*—Refer Art. 60, Chap. IX. The maximum value of the air-gap density under full-load conditions may be read off curve *C* of Fig. 84 (page 221) where it is seen to be 10,800 gauss. The corresponding tooth density, as read off Fig. 81 (page 216), is 23,100. This is the density at the narrowest part of the tooth. On the assumption that flux neither enters nor leaves the tooth up to a distance  $d_s$  from the bottom of the slot (see Fig. 38, page 122), the tooth densities at the three sections considered are  $B_w = 18,870$ ,  $B_m = 21,000$ , and  $B_n = 23,100$  gauss. Referring to Fig. 34 (page 102), we find the watts per pound corresponding to these densities to be 4.1, 4.8, and 5.5, respectively, the mean value being 4.8. The total weight of iron in the teeth (item (57)) is 75 lb., and the corrected total loss in the teeth is  $75 \times 4.8 = 360$  watts.

*Items (148) and (149): Efficiency at Any Output.*—Refer Art. 60, Chap. IX. The efficiency table on page 235 requires but little explanation. Each column stands for a particular output, expressed as a fraction of rated full load. The terminal voltage is calculated on the assumption that it conforms to a straight-line law based on the known full-load and no-load voltages.

The windage and friction loss is taken as 1.8 per cent. of the full-load output (see page 196).

The core loss—which includes the corrected tooth loss—is the calculated full-load value. It will actually vary somewhat with



the load (and developed voltage), but for practical purposes may be assumed constant.

The constant losses are made up as follows:

Windage and bearing friction = $0.018 \times 75,000 = 1,350$ watts.
Brush friction (item (113))..... = 324 watts.
Iron loss in core and teeth (item 60)..... = 1,644 watts.
Total..... = 3,318 watts.

The full-load current in the armature is the line current plus the shunt current (item (136)), and since the armature resistance



FIG. 88.—Efficiency curve.

is known (item (44)), the  $I^2R$  loss in the armature at different loads can readily be calculated.

The brush-contact  $I^2R$  loss is obtained by referring to Fig. 69 (page 179) and adding 25 per cent. to the calculated losses.

We shall assume the “long shunt” connection, which means that the series winding and diverter will, together, carry the full armature current, and the series field  $I^2R$  losses will therefore be directly proportional to the copper losses in the armature.

Fig. 88 is the efficiency curve plotted from the figures in the table. The full-load efficiency is 0.915, and judging by the shape



**PROCEDURE IN DESIGN OF D.C. GENERATOR 235**

of the curve, the maximum efficiency of 0.92 will probably be obtained with an overload of about 25 per cent.

**EFFICIENCY TABLE**

Load output.....	0	¼	½	¾	1	1¼
Terminal voltage.....	220	222.5	225	227.5	230	232.5
Line current.....	0	84.3	167	247	326	403
Constant power loss.....	3,318	3,318	3,318	3,318	3,318	3,318
Armature I <sup>2</sup> R loss.....		111	419	897	1,540	2,342
Brush-contact I <sup>2</sup> R loss.....		152	322	528	744	964
Series field and diverter.....		20	76	162	278	423
Shunt field and rheostat.....	960	980	1,000	1,025	1,050	1,070
Total loss.....	4,278	4,582	5,135	5,930	6,930	8,117
Output (watts).....	0	18,750	37,500	56,250	75,000	93,750
Input (watts).....	4,278	23,332	42,635	62,180	81,930	101,867
Efficiency (per cent.).....	0	80.3	87.8	90.5	91.5	92

Referring to the usual efficiencies of commercial machines as given on page 197, it is seen that the calculated value of 91.5 compares favorably with the average value of 91.2 for a 75-kw. dynamo.

**64. Design of Continuous-current Motors.**—The dynamo being a reversible machine, may be used as a generator to convert mechanical into electrical energy, or as a motor to convert electrical into mechanical energy. If the machine is to be used as a motor, the efficiency should first be estimated by referring to the figures on page 197. This efficiency, in the case of a motor, is the ratio  $\frac{\text{output}}{\text{input}}$ , whence

$$\text{Kw.} = \frac{\text{horsepower} \times 746}{\text{efficiency} \times 1,000}$$

and the design may be proceeded with exactly as if the machine were to be used as a generator to give this particular kilowatt output at the specified speed.

It is even more important in a motor than in a generator that the machine should work sparklessly at all loads without change of the brush position. The specification usually calls for operation without destructive sparking from zero load to 25 per cent. overload, with the brushes in a fixed position. If the direction of revolution of the motor is to be reversible, it is necessary for the brushes to be on the geometric neutral line, a condition which is usually met by providing commutating interpoles.

On account of the conditions under which they have to operate, dynamo machines when used as motors are more often totally enclosed than when used as generators. In the case of the larger units forced ventilation would then be resorted to, but the smaller sizes may be self-cooling. The temperature rise is then largely equalized throughout the machine, and somewhat higher surface temperatures are allowable than in the case of open-type machines. A temperature rise of 60°, by thermometer, is allowable inside the machine but this means that the temperature rise of the enclosing case must be considerably less than this, say 35° or 40°C.

In the absence of data on the particular type of enclosed motor under consideration, a cooling coefficient of 0.008 to 0.01 may be used. This figure denotes the number of watts that can be radiated per degree Centigrade rise of temperature from every square inch of the entire external surface of the enclosed motor.

## CHAPTER XI

### DESIGN OF ALTERNATORS—FUNDAMENTAL CONSIDERATIONS

**65. Introductory.**—In the continuous-current dynamo the function of the commutator is merely to rectify the armature currents in order that a machine with alternating e.m.fs. generated in its windings shall deliver unidirectional currents at the terminals. It may therefore be argued that the design of alternating-current generators should be taken up before that of D.C. dynamos, the changes caused by the addition of the commutator being considered in the second place. There are, however, many matters of importance to be considered in connection with an alternating-current generator, which have no part in the design of a continuous-current dynamo. Among these may be mentioned the effects due to changes in wave shapes of e.m.f. and current; the importance of the inductance, not only of the armature itself, but also of the circuit external to the generator; and the fact that the voltage regulation depends not only on the  $IR$  drop, but also on the power factor of the load, *i.e.*, on the phase displacement of the current relatively to the e.m.f. The problems to be solved being somewhat less simple than those connected with continuous-current machines, the writer believes that the arrangement of the subject as followed in this book is justified.

It is proposed to treat the design of A.C. machines as nearly as possible on the lines followed in the D.C. designs. In order to avoid unnecessary repetitions, references will be made to previous chapters and stress will be laid on the essentials only, particular attention being paid to the points of difference between A.C. and D.C. machinery.

The design of asynchronous generators will not be touched upon. This type of machine is essentially an induction motor reversed, the rotor, with its short-circuited windings, being mechanically driven. The writer has explained elsewhere the principles underlying the working of these machines,<sup>1</sup> and since they

<sup>1</sup> ALFRED STILL: "Polyphase Currents," WHITTAKER & Co.

are of a type not commonly met with, they will not again be referred to.

The remainder of this book will be devoted to a study of the synchronous alternating-current generator, and since multipolar polyphase generators with stationary armatures are more common than any other type, they will receive more attention than the less frequently seen designs; but the case of the high-speed, steam-turbine-driven units, with a small number of poles and distributed field windings, will also be considered.

Apart from the absence of commutator, the chief point of difference between an A.C. and D.C. generator is that the frequency of the former is specified, whereas, in the latter, this is a matter which concerns the manufacturer only. It follows that, for a given speed, the number of poles is determined by the frequency requirements, and this fact necessarily influences the design. In Europe a frequency of 50 cycles per second is common, the idea being that this is high enough for lighting purposes while being sufficiently low to allow of the same circuits being used occasionally for power purposes also. A lower frequency is usually to be preferred for power schemes, and the standards in America are 25 cycles for power purposes and 60 cycles for lighting.

**66. Classification of Synchronous Generators.**—It is well to distinguish between two classes of alternators:

1. Machines with salient poles, driven at moderate speeds by belt, or direct-connected to reciprocating steam, gas, or oil engines, or to water turbines. The peripheral speed of the rotating part (usually the field magnets) will generally lie between the limits of 3,000 and 8,000 ft. per minute.

2. Machines direct-coupled to high-speed steam turbines, in which the peripheral velocity usually exceeds 12,000 ft. per minute, is commonly about 18,000, and may attain 24,000 ft. per minute. In these machines the field system is always the part that rotates; the number of poles is small, and although salient poles are sometimes used on the lower speeds, the cylindrical field magnet with distributed windings is more common. The mechanical problems encountered in the design of these high-speed machines are relatively of greater importance than the electrical problems; but since these are beyond the scope of this book, they will not be considered in detail. Such differences as occur in the electrical calculations will be pointed out as the work proceeds.

Referring again to the type of generator to operate at moderate speeds, it is not necessary for the field to rotate, and small units, especially when the voltage is low, may be built generally on the same lines as D.C. dynamos, *i.e.*, with rotating armatures and an external crown of poles. In this case the commutator is replaced by two or more slip rings connected to the proper points on the armature winding. For a three-phase generator three slip rings are required, and since two rings only are necessary if the field rotates, the design with stationary armature is the more common. It should also be observed that the insulation of the slip rings for the comparatively low voltage of the exciting circuit offers no difficulty, whereas the insulation of the alternating-current circuit may have to withstand fairly high pressures.

The field magnet windings of salient pole alternators are generally similar to those of D.C. dynamos, that is to say, all the poles are provided with exciting coils. Machines have been built in the past with windings on alternate poles only; with a single exciting coil (as in the "MORDEY" flat-coil alternator); and, again, without any windings on the rotating part. The latter type is known as the inductor alternator, and the field winding is then put on the stationary armature rings, thus dispensing with slip rings for the collection of either alternating or continuous current. Iron projections on the rotating part so modify the reluctance of the magnetic circuit through the armature coils that alternating e.m.f.s. are generated therein; but these machines, together with those having single exciting coils, have the disadvantage that the magnetic leakage is very great and the design therefore uneconomical.

**67. Number of Phases.**—Whether a machine is to supply single-phase, two-phase, or three-phase, currents does not appreciably affect the design. The calculations on a machine for a large number of phases are not more difficult than when the number of phases is small. The theory of the single-phase generator is, in fact, somewhat less simple than that of the polyphase machine. In the succeeding articles it is the three-phase generator that we shall mainly have in mind, because it is the most commonly met with, but the points of difference in the electrical design of single-phase and polyphase generators will be pointed out as they arise.

Whatever may be the type of machine, or number of poles, we may consider the armature conductors to be cut by the mag-



netic lines in the manner indicated in Fig. 89. Here we have a diagrammatic representation of single-phase, two-phase, and three-phase, windings. In each case, the system of alternate pole pieces is supposed to move across the armature conductors in the direction indicated by the arrow.

It will be noted that the conductors of each phase are shown connected up to form a simple wave winding; but this is only done to simplify the dia-

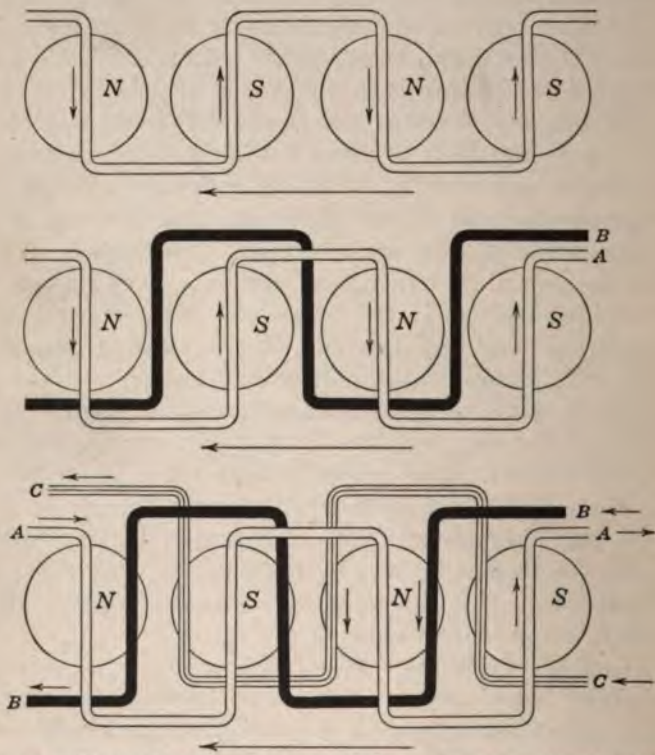

FIG. 89.—Single-phase, two-phase, and three-phase, armature windings.

gram, and it will be readily understood that each coil may contain a number of turns, attention being paid to the manner of its connection to the succeeding coil, in order that the e.m.f.s. generated in the various coils shall not oppose each other.

The upper diagram shows a single winding, in which an alternating e.m.f. will be generated. In the middle diagram there are two distinct windings, A and B, so placed on the armature surface that the complete cycle of e.m.f. variations induced in

*A* will also be induced in *B*, but after an interval of time representing a quarter of a period. This diagram shows the positions of the poles at the instant when the e.m.f. in *A* is at its maximum, while in *B* it is passing through zero value. From these two windings we can, therefore, obtain two-phase currents with a phase displacement of 90 electrical degrees.

In the bottom diagram the arrangement of three windings is shown, from which three-phase currents can be obtained, with a phase angle between them of 120 degrees, or one-third of a cycle. It will be seen that, at the instant corresponding to the relative positions of coils and poles as indicated on the diagram, the e.m.f. in *A* is at its maximum, while in *B* and *C* it is of a smaller value and in the opposite direction.

**68. Number of Poles. Frequency.**—For a given frequency the number of poles will necessarily depend upon the speed. Thus  $p = \frac{120f}{N}$ , where *N* stands for the speed in revolutions per minute. Since *f* is usually either 25 or 60, it follows that *N* must be some definite multiple of the number of poles *p*.

**69. Usual Speeds of A.C. Generators.**—The speed at which a machine of a given kilowatt output should be driven will depend upon the prime mover. The speed may be very low, as when the generator is direct-coupled to a slow-speed steam engine or low-head waterwheel. Higher speeds are obtained when the generator is belt-driven or direct-coupled to high-speed steam or oil engines. Very high speeds are necessary when the generator is direct-connected to a steam turbine.

For usual speeds the reader is referred to the table on page 81, the values there given being applicable to both D.C. and A.C. machines. In hydro-electric work the generator is usually direct-coupled to the waterwheel, the speed of which will be high in the case of impulse wheels working under a high head. As an example, a PELTON waterwheel to develop 1,500 hp. under a head of 1,000 ft. would have a wheel about 5 ft. in diameter, running at 500 revolutions per minute. This would be suitable for direct coupling to a six-pole 25-cycle generator.

In the case of steam turbines—with a blade velocity of about 5 miles per minute—the speeds are always very high. The actual speed best suited to a given size of unit will depend upon the make of the turbine, but the following table gives the approximate range of speeds covered by modern steam turbines.



Output, kilowatts	Approximate range of speed, revolutions per minute
2,000.....	3,000 to 6,000
5,000.....	2,000 to 4,000
10,000.....	1,200 to 2,500
20,000.....	900 to 1,800

### 70. E.m.f. Developed in Windings.—

Let  $\Phi$  = flux per pole (maxwells).

$N$  = revolutions per minute.

$p$  = number of poles.

The flux cut *per revolution* is then  $\Phi \times p$  and the flux cut *per second* is  $\Phi p \frac{N}{60}$ . The average value of the e.m.f. developed in each armature conductor must therefore be

$$E_c \text{ (mean)} = \frac{\Phi p N}{60 \times 10^8} \text{ volts.}$$

If the space distribution of the flux density over the pole pitch follows the sine law, the virtual value of the e.m.f. is 1.11 times the mean value. In other words, the *form factor*, or ratio  $\frac{\text{r.m.s. value}}{\text{mean value}}$ , is  $\frac{\pi}{2\sqrt{2}}$ , or 1.11, in the case of a sine wave.

*Concentrated and Distributed Windings.*—If each coil-side may be thought of as occupying a very small width on the armature periphery, and if the coil-sides of each phase winding are spaced exactly one pole pitch apart, the arrangement would constitute what is usually referred to as a concentrated winding. With a winding of this kind, all conductors in series in one phase would always be similarly situated relatively to the center lines of the poles, and the curve of induced e.m.f. would necessarily be of the same shape as the curve of flux distribution over the armature surface. In practice, a winding with only one slot per pole per phase would be thought of as a concentrated winding. When there are two or more slots per pole per phase, the winding is said to be distributed; and since the conductors of any one phase cover an appreciable space on the armature periphery, all the wires that are connected in series will not be moving in a field of the same density at the same instant of time. Except in the case of a sine-wave flux distribution, the form factor may depend largely upon whether the winding is concentrated or distributed. The wave shape of the developed voltage can always be determined when the flux distribution is known; but,

in the preliminary stages of a design, it is usual to assume that the pole shoes are so shaped as to give a sinusoidal distribution of flux over the armature surface. The calculation of a correcting factor for distributed windings is then very simple. Thus, if there are two slots per pole per phase in a three-phase machine, there will be six slots per pole pitch, the angular distance between them being  $\frac{180}{6} = 30$  electrical degrees. It is therefore merely necessary to add together, vectorially, two quantities having a phase displacement of 30 degrees, each representing the e.m.f. developed in a single conductor. The result, divided by 2, will be the average voltage per conductor of the distributed winding. As an example, with three slots per pole per phase, the graphic construction would be as indicated in Fig. 90 where length  $AB = \text{length } BC = \text{length } CD$ , and what may be called the *distribution factor* is  $k = \frac{AD}{3AB}$ . The value of this distribu-

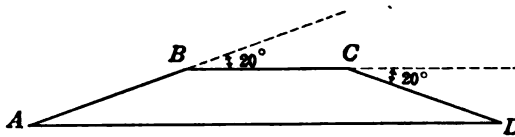

FIG. 90.—Vector construction to determine distribution factor.

tion factor is therefore always either equal to, or less than, unity.

If  $Z$  = the total number of inductors in series *per phase*, the final formula for the developed voltage is:

$$E \text{ (per phase)} = \frac{kZ\Phi pN}{60 \times 10^8} \times \text{form factor} \tag{93}$$

On the sine wave assumption, the form factor is 1.11, and the formula may, if preferred, be used in the form

$$E \text{ (per phase)} = \frac{2.22kf\Phi Z}{10^8} \text{ volts (on sine-wave assumption)} \tag{94}$$

Values of  $k$  can easily be calculated for any arrangement of slots and windings. With a full-pitch three-phase winding, the distribution factor,  $k$ , will have the following values:

Number of slots per pole per phase	Distribution factor, $k$
1 .....	1.0
2 .....	0.966
3 .....	0.960
4 .....	0.958
Infinite .....	0.955

**71. Star and Mesh Connections.**—Consider the armature winding of an ordinary continuous-current two-pole dynamo. If we imagine the commutator of such a machine to be entirely removed, the winding—whether the armature be of the drum or ring type—will be continuous, and closed upon itself. If the armature be revolved between the poles of separately excited field magnets, there will be no circulating current in the windings, because the magnetism which passes out of the armature core induces an e.m.f. in the conductors exactly opposite, but equal in amount, to that induced by the entering magnetism.

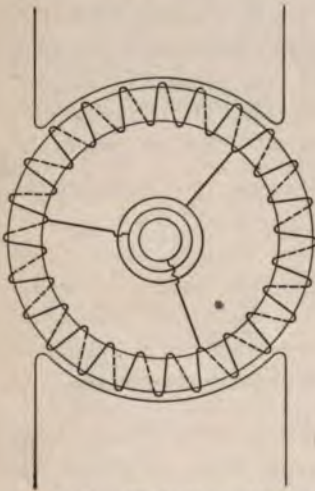

FIG. 91.—Collection of three-phase currents from bi-polar ring armature.

If we now connect two points of the winding from the opposite ends of a diameter to a pair of slip rings, the machine will be capable of delivering an alternating current. If we provide three slip rings, and connect them respectively to three points on the armature winding distant from each other by 120 degrees, the machine will become a three-phase generator.

In this manner polyphase currents of any number of phases can be obtained, and if the windings and field poles are symmetrically arranged, there will be no circulating current.

This method of connecting up the various armature circuits of a polyphase generator is known as the *mesh* connection. In the case of three-phase currents it is usually referred to as the *delta* connection.

The diagram, Fig. 91, shows the three equidistant tappings from armature winding to slip rings, required to obtain three-phase currents. It is evident that the potential difference between any two of the three rings will be the same, since each section of the winding has the same number of turns, and occupies the same amount of space on the periphery of the armature core. Moreover, the variations in the induced e.m.f. will occur successively in the three sections at intervals corresponding to one-third of a complete period.



The load may be connected across one, two, or three, phases; but in practice, especially in the case of power circuits, the three-phase load is usually *balanced*; *i.e.*, each phase winding of the machine provides one-third of the total output.

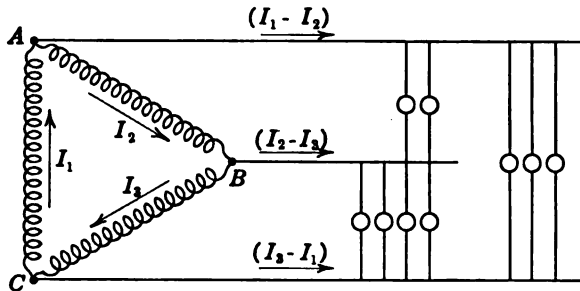

FIG. 92.—Diagram of connections for delta-connected three-phase generator.

Fig. 92 is a diagram of connections referring to a delta-connected three-phase generator, and Fig. 93 is the corresponding vector diagram, showing how the current in the external circuit may be expressed in terms of the armature current. The current leaving the terminal A (Fig. 92) is  $I_1 - I_2$ , and since there will be a difference of 120 electrical degrees between the currents  $I_1$  and  $I_2$ , the vector construction of Fig. 93 gives  $OI$  as the line current. Its value is  $I = 2I_a \cos 30^\circ$ , or  $\sqrt{3}I_a$ , where  $I_a$  is the current in the armature conductors. The assumptions here made are that the load is balanced and that the current variations follow the simple harmonic law. It is well

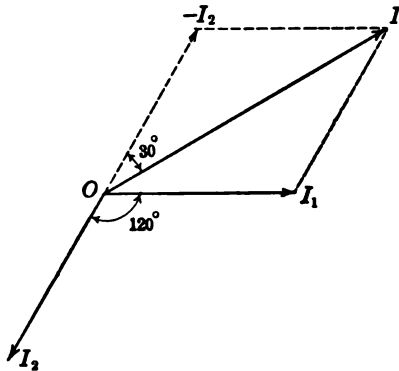

FIG. 93.—Vector diagram of current relations in delta-connected three-phase generator.

to bear in mind that vectors and vector calculations can be used only when the variable quantities follow the sine law; when used in connection with irregular wave shapes, they must be supposed to represent the “equivalent” sine function, because under no other condition can the phase angle have any definite meaning.

*Star Connection of Three-phase Armature Windings.*—If the starting ends of all the phase windings of a polyphase generator are connected to a common junction, or *neutral point*, the armature windings are said to be star-connected. In the three-phase machine this is also referred to as the Y connection. The outgoing lines being merely a continuation of the phase windings, it follows that, with a star-connected machine, the line current is exactly the same as the current in the armature windings. The voltage between terminals is, however, no longer the same as the phase voltage, as in the case of the previously considered mesh-connected machine. Referring to the vector diagram Fig. 94, we see that the voltage between lines 1 and 2 is  $E_1 - E_2$ , which leads to the relation  $E = \sqrt{3}E_a$  where  $E$  is

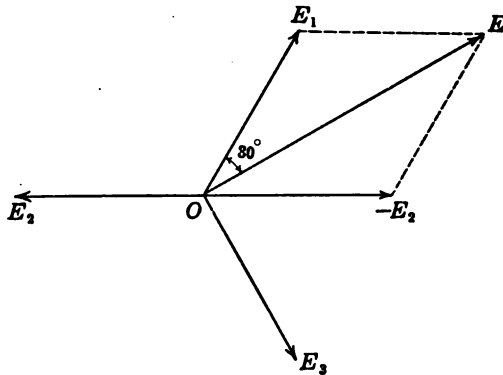

FIG. 94.—Vector diagram showing voltage relations in Y-connected three-phase generator.

the terminal voltage, and  $E_a$  the phase voltage as measured between any one terminal and the neutral point.

There is little to be said in regard to the choice of armature connections in a three-phase generator, except that, for the higher pressures, the Y connection has the advantage of a lower voltage per phase winding, and, for heavy current outputs, the  $\Delta$  connection has the advantage of a smaller current per phase winding.

*Effect of Star and Delta Connections on Third Harmonic.*—There is one difference resulting from the method of connecting the phase windings of a three-phase generator which should be mentioned. This has reference to the wave shape of the e.m.f. The wave shape of the terminal voltage is not necessarily the

same as that of the e.m.f. developed in the armature windings. Thus, what is known as the third harmonic, and all multiples of the third harmonic, are absent from the voltage measured across the terminals of a star-connected three-phase generator. By the third harmonic is meant a sine wave of three times the periodicity of the fundamental sine wave, which, when superimposed on this fundamental wave, produces distortion of the wave shape.

A voltmeter placed across the terminals of a star-connected generator measures the *sum* of two vector quantities with a phase difference of 60 degrees (see Fig. 94). Since a phase displacement of 60 degrees of the fundamental wave is equivalent to a phase displacement of  $60 \times 3 = 180$  degrees of the third harmonic, it follows that the third harmonics cancel out so far as their effect on the terminal voltage is concerned. The general rule is that the  $n$ th harmonic and its multiples cannot appear in the terminal voltage of a star-connected polyphase generator of  $n$  phases. The same arguments apply to the line current of a mesh-connected polyphase generator; the  $n$ th harmonic of the current wave can circulate only in the armature windings; it cannot make its appearance in the current leaving the terminals of the machine.

**72. Power Output of Three-phase Generator.**—Let  $E$  and  $I$  be the line voltage and line current, and let  $E_a$  and  $I_a$  stand for the phase voltage and armature current, respectively; then, in the  $\Delta$ -connected machine,

$$E = E_a$$

and

$$I = \sqrt{3}I_a$$

while, in the Y-connected machine,

$$E = \sqrt{3}E_a$$

and

$$I = I_a$$

Assuming unity power factor, we may write:

$$\begin{aligned} \text{Output of } \Delta\text{-connected machine} &= 3(E_a I_a) \\ &= 3E \times \frac{I}{\sqrt{3}} \\ &= \sqrt{3}EI \end{aligned}$$

and, similarly,

$$\begin{aligned}
 \text{Output of Y-connected machine} &= 3(E_a I_a) \\
 &= 3 \frac{E}{\sqrt{3}} \times I \\
 &= \sqrt{3} EI
 \end{aligned}$$

The total output is, of course, the same in both cases. If the power factor is not unity, the output, in watts, of the three-phase generator on a balanced load is:

$$W = \sqrt{3} EI \cos \theta.$$

where  $\theta$  is the angle of lag between terminal e.m.f. of a phase winding and current in the winding. The quantity  $\cos \theta$  is the power factor when both current and e.m.f. waves are sinusoidal.

Since the magnetic circuit of an alternating-current generator has to be designed for a certain flux to develop a given voltage, while the copper windings must be of sufficient cross-section to carry a given current, the size of the machine will depend upon the product of volts and amperes, and not upon the actual power output. Alternating-current generators are therefore rated in kilovolt-amperes (k.v.a.), the actual output, in kilowatts, being dependent upon the power factor of the external circuit.

**73. Usual Voltages.**—Owing to the absence of the commutator, A.C. machines can be wound for higher voltages than D.C. machines. Large A.C. generators may be wound to give as high a pressure as 16,000 volts at the terminals, but it is rarely economical to develop much above 13,000 volts in the generator; when higher pressures are required, as for long distance power transmission, step-up transformers are used. In this country, a very common terminal voltage for three-phase generators to be used in connection with step-up transformers, is either 2,200 or 6,600 volts, the higher voltage being adopted for the larger outputs, in order to avoid heavy currents in the machine and between the machine and the primary terminals of the transformer.

**74. Pole Pitch and Pole Arc.**—Although there can be no sparking at the sliding contacts, as in D.C. designs, with their commutation difficulties, the effects of field distortion and demagnetization are apparent in the voltage regulation of alternating-current generators. A very large pole pitch, involving as it does a large number of ampere-conductors per pole, is objectionable, and should be avoided if possible. Where it is unavoidable, a large air gap must be provided in order to prevent

the armature m.m.f. overpowering the field excitation; but this leads to increased cost.

The pole pitch,  $\tau$ , is a function of the peripheral speed and the frequency, thus:

$$\tau = \frac{\pi D}{p}$$

where  $p$  = number of poles, and  $D$  = diameter of armature (inches).

But

$$v = \frac{\pi DN}{12}$$

and

$$f = \frac{pN}{120}$$

where  $v$  = peripheral velocity of armature in feet per minute. It follows that

$$\tau = \frac{v}{10f} \quad (95)$$

which explains why the pole pitch is always large in steam-turbine-driven alternators.

In 60-cycle machines running at moderate speeds, the pole pitch usually lies between 6 and 12 in., a pitch of 8 to 10 in. being very common. The speed of the machine—which is usually a factor in determining the peripheral velocity—has an appreciable influence upon the choice of pole pitch; pole cores of approximately circular or square section are not always feasible or economical, and the designer must make some sort of a compromise to get the best proportions. The output formula, as used for determining the proportions of dynamos, is not so readily applicable to the design of alternators, because the armature diameter in A.C. machines will be settled largely by considerations of peripheral velocity and pole pitch, the proportions of the pole face being a secondary matter. The value of  $k$ , or ratio  $\frac{\text{pole arc}}{\text{armature length}}$ , is therefore determined largely by the limits of peripheral velocity, which may lead to a smaller diameter and greater axial length than would be strictly economical if the weight of copper in the field coils were the only consideration.

It is usual, when possible, to limit the armature ampere-turns per pole to 10,000, which will determine the maximum permis-



sible value of the pole pitch; but this limit must sometimes be exceeded, as in the case of steam-turbine-driven machines, in which a pole pitch of 3 to 4 ft. is by no means uncommon.

The pole arc is a smaller portion of the total pitch than in continuous-current machines; the value of  $r$  (*i.e.*, the ratio  $\frac{\text{pole arc}}{\text{pole pitch}}$ ) rarely exceeds 0.65. A very common value is 0.6, while it may frequently be as low as 0.55. The reason for the smaller circumferential space occupied by the pole face is partly to avoid excessive magnetic leakage, but mainly to provide a proper distribution of flux over the pole pitch. An attempt is usually made to obtain sinusoidal distribution; but the means of obtaining this will be explained later.

**75. Specific Loading.**—As in the case of D.C. machines, the specific loading,  $q$ , is defined as the number of ampere-conductors per inch of armature periphery. The conductors of all phases are counted, and the current considered is the virtual, or r.m.s., value of the armature current. The magnetizing effect of the armature as a whole will, at any moment, depend upon the instantaneous value of the currents in the individual conductors, but this matter will be taken up later.

The following are average values of  $q$ , as found in commercial machines:

Output of A.C. generator (k.v.a.)	Average value of $q$
50	400
100	430
200	470
500	520
1,000	570
5,000	625
10,000	670

The proper value of  $q$  to be used in a given design will depend on several factors. Apart from the fact that its value increases with the size of the machine, it will depend somewhat upon the following factors:

- (a) Number of poles.
- (b) Frequency.
- (c) Voltage.

(a) Machines with a small number of poles usually have a small armature diameter and a large pole pitch; calling for a *small* value of  $q$ . In modern steam-turbine-driven generators

there is, however, a tendency to use high values of  $q$  in order to limit the length of the armature (and increase the critical speed) and also to increase the armature m.m.f. with a view to lowering the short-circuit current.

(b) With low frequency it is easy to keep the iron loss small, and more copper, or a greater current density in the conductors, is permissible.

(c) If the e.m.f. is low, the insulation occupies less space, and there is more room for copper without unduly reducing the cross-section of the armature teeth.

The approximate figures given in the above table may be increased or reduced about 20 per cent., the highest values being used only when there is a combination of low voltage, low frequency, and large number of poles.

**76. Flux Density in Air Gap.**—Since the pole shoe is shaped to give as nearly as possible a sinusoidal distribution of flux density over the pole pitch, it is convenient to think of the *maximum* value of the air-gap density, because this will determine the maximum density in the iron of the teeth. The frequency being usually higher than in D.C. machines, lower tooth densities must be used in order to avoid excessive loss. The allowable flux density in the air gap will depend upon the proportions of tooth and slot; but the following values may be used for preliminary calculations.

For a frequency of 25,  $B_g = 4,000$  to  $5,800$  gausses.

For a frequency of 60,  $B_g = 3,500$  to  $5,000$  gausses.

These values of  $B_g$  stand for the *average density over the pole pitch*. If  $\Phi$  = the total number of maxwells per pole; and the shape of the flux distribution over the pole pitch is assumed to be a sine wave, we have:

$$\text{Area of pole pitch} = \frac{\Phi}{B_g}$$

which determines the axial length of the armature core. The maximum air-gap density, on the above assumption, is  $\frac{\pi}{2} B_g$ , and after deciding upon the tooth and slot proportions, it is advisable to see that this density will not lead to an unreasonable value for the apparent tooth density. As a check, it may be stated that the tooth density in alternators is rarely higher than 18,000 gausses in 25-cycle machines, and 16,000 gausses in 60-cycle

machines. Higher densities are used in some steam-turbine-driven machines, with a view to reducing the size of the rotor. A good system of forced ventilation is then imperative.

**77. Length of Air Gap.—Inherent Regulation.**—In A.C. machines, just as in D.C. machines, the length of air gap should depend upon the armature m.m.f and therefore on the pole pitch,  $\tau$ , and the specific loading,  $q$ . In salient-pole machines, the air gap will not be of constant length, but will increase from the center outward, in order to produce the required distribution of flux. A practical method of shaping the pole face will be explained later. The clearance to be allowed between pole face and armature surface at the center of the pole may be determined approximately by making it of such a length that the open-circuit field ampere-turns shall be not less than 1.75 times to twice the full-load armature ampere-turns. In large turbo-alternators this ratio may be as low as 1 to 1.5, in order to reduce the weight of copper on the rotor, and keep the short-circuit current within reasonable limits. The distribution of armature m.m.f. will be discussed later; but, for the purpose of estimating the air gap, the ampere-turns per pole may be taken as  $\frac{q\tau}{2}$ .

In no case should the air gap be less than one-third to one-half the slot opening.

A large air gap has the effect of improving the regulation of the machine; but otherwise it is objectionable, seeing that it leads to increased magnetic leakage and higher cost, due mainly to the greater weight of copper in the field coils.

The *inherent regulation* of a generator, at any given load, may be defined as the percentage increase in terminal voltage when the load is thrown off; the speed and field excitation remaining constant. Owing to the low power factors resulting from the connection of induction motors on alternating-current circuits, it is practically impossible to design a generator of which the inherent regulation is so good that auxiliary regulating devices are unnecessary. It is, therefore, uneconomical to aim at very good inherent regulation, especially as efficient automatic field regulators are now available. The inherent regulation of commercial machines usually lies between 5 and 9 per cent. at full load on unity power factor, while it may easily be 20 per cent., or higher, on 85 per cent. power factor, with normal full-load current taken from the machine. This very marked effect of



a low power factor will be explained later in detail; but it may be stated here that the effect of a lagging armature current is very similar to that of a change of brush position in a continuous-current dynamo, causing the armature ampere-turns—which on unity power factor have merely a distorting effect—to become partly demagnetizing.

Not only must the armature be weak relatively to the field, but the inductance of the armature windings should be small if the inherent regulation is to be good. Thus the regulating qualities of an alternating-current generator depend on both armature *reaction* and armature *reactance*; but since these cannot be made so small as to dispense entirely with external regulating devices, the designer rarely aims at getting very good inherent regulation.

With steam-turbine-driven machines, in which the pole pitch is always very large, the air gap frequently exceeds 1 in. in length. The writer knows of a machine, designed for an output of 5,500 k.v.a. at a speed of 1,000 revolutions per minute, and a frequency of  $33\frac{1}{3}$ , with the single air gap  $3\frac{1}{4}$  in. long. Whether or not the designer was justified in trying to obtain satisfactory regulation by this costly and somewhat crude expedient is at least questionable. Machines of three times this output are now built with air gaps from 1 in. to  $1\frac{1}{4}$  in. long.

Good inherent regulation means that the current on short-circuit may be very large, and this is sometimes objectionable. With the exception of high-speed, steam-turbine-driven units, the short-circuit current in modern A.C. generator (with full-field excitation) is about three to five times the normal full-load current; but in connection with the larger units, and on systems dealing with large amounts of energy, power-limiting reactances, external to the generator, are usually installed to prevent the current attaining a dangerous value before the automatic circuit-breakers have had time to operate. Many of the largest units, driven at very high speeds by steam turbines, are now purposely designed with large armature reaction and highly inductive windings, in order that they may be able to withstand momentary short-circuits without mechanical injury; but notwithstanding these features of recent introduction, the momentary short-circuit current in some of the 20,000 to 30,000 k.v.a. units, may be of the order of 15 to 20 times the normal full-load current.

For certain electro-metallurgical work, or electric smelting,

as, for instance, the electric production of calcium carbide, an alternator with poor regulation is desirable. In other words, where a *constant-power* machine is needed, a powerful armature reaction and magnetic leakage are useful; with a decrease in the resistance of an electric furnace, the current will rise, but if this increase of current causes a falling off in the pressure at the generator terminals, the power consumed will not increase to any appreciable extent.



## CHAPTER XII

### ARMATURE WINDINGS—LOSSES, AND TEMPERATURE RISE

**78. Types of Windings.**—Fundamental winding diagrams for single-, two-, and three-phase, machines were illustrated and explained in the preceding chapter (Art. 67). Beyond this it is not proposed to say much regarding the actual arrangement of armature windings in alternating-current generators. Much excellent matter has been published on the practice of armature winding;<sup>1</sup> but it has little to do with the principles of electric design, and, in the end, is really a study of the most convenient and economical way of connecting together the active conductors in the slots. There is almost no limit to the number of styles of winding that can be used on alternators, or to the names that may be, and are, given to these different windings; but the fundamental principles underlying the generation of an alternating e.m.f. can be studied without a detailed knowledge of the many practical types of armature windings.

There is one broad distinction that can be made, and alternator windings may be divided into:

- (a) Double-layer windings.
- (b) Single-layer windings.

(a) *Double-layer Winding.*—This is practically identical with the usual D.C. winding, the coils being generally of the same shape; but instead of tappings being taken to a commutator, the coils are connected together in the proper order, the phase windings being kept separate until finally connected star or mesh as may be decided. With this style of winding, the number of conductors per slot must be a multiple of two. All coils are of the same size and shape, which is an advantage; but on the other hand, the end connections are rather close together, and there must also be substantial insulation between the two coil-sides in each slot. This type of winding is, therefore, not very suitable for high pressures. One great advantage of the double-layer

<sup>1</sup> MILES WALKER: "Specification and Design of Dynamo-electric Machines," LONGMANS & Co.

winding is that it lends itself readily to fractional pitch lap windings, in which the two sides of a coil are not similarly placed relatively to the center lines of the poles, with the result that tooth harmonics in the e.m.f. wave may be almost eliminated.

(b) *Single-layer Winding*.—With this winding there is only one coil-side in a slot, and the number of conductors per slot may, therefore, be either odd or even. Several shapes of coil are

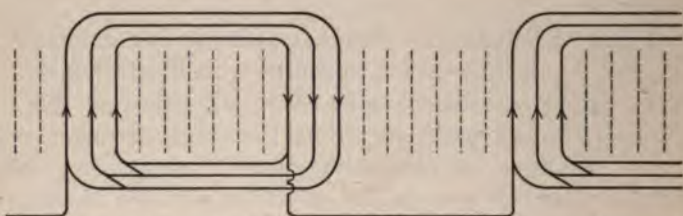

FIG. 95.—Three-phase, single-layer winding; three slots per pole per phase.

necessary in order that the end connections may clear each other, and this involves a larger number of special tools or formers and a larger number of spare coils than for a double-layer winding. These disadvantages are, however, sometimes outweighed by the fact that the total number of coils in the machine is smaller. Good insulation is easily obtained because the end connections may be separated by large air spaces, and the single-layer winding is, therefore, suitable for high voltages.

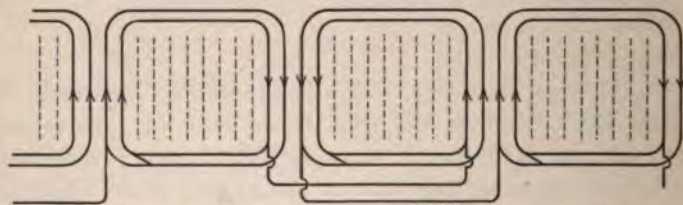

FIG. 96.—Three-phase, single layer winding; four slots per pole per phase

Considering each phase winding separately, the full number of turns per pole may encircle one pole only as shown in Fig. 95, or they may be divided between a pair of poles, in two equal parts, as shown in Fig. 96. Both diagrams show one phase only of a three-phase generator. In Fig. 95 there are three slots, while in Fig. 96 there are four slots, per-pole per phase. The coils of the other phase windings would be similarly arranged in the remaining slots, the ends projecting beyond the slots being shaped



or bent so as to clear the other coils, generally as shown in Fig. 97.

All the conductors of one phase are usually connected in series, but sometimes parallel circuits are used. It then becomes a matter of importance to see that there is no phase difference between the e.m.fs. generated in the conductors of parallel circuits. In other words, the conductors of parallel circuits should be so disposed in the available slots that they cut the same amount of flux at the same instant of time. Having mentioned this point, it does not appear necessary to enlarge upon it.

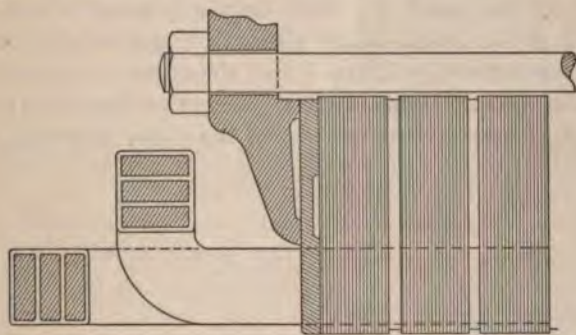

FIG. 97.—End connections of single-layer armature winding.

**79. Spread of Windings.**—In two-phase and three-phase machines, all the slots on the armature are utilized. With full-pitch windings,<sup>1</sup> the number of slots per pole is divisible by 2 for a two-phase generator, and by 3 for a three-phase generator. Thus, with distributed windings (more than one slot per pole per phase), the “spread,” or space occupied by each phase winding, is  $\frac{180}{2} = 90$  electrical degrees for a two-phase machine, and  $\frac{180}{3} = 60$  degrees for a three-phase machine.

In single-phase machines, nothing is gained by winding all the slots on the armature surface; after a certain width of winding has been reached, the filling of additional slots merely increases the resistance and inductance of the winding, without any appreciable gain in the matter of developed voltage. This is

<sup>1</sup> Short-pitch windings are very common in two-pole machines, as they tend to simplify the end connections. In this case the double-layer winding, as in D.C. machines, would be used.

## ELECTRICAL DESIGN

The vector diagram, Fig. 98. The winding is sup-  
 posed to be distributed in a very large number of slots, and the  
 arc  $ABC$  represents the resultant generated  
 if all the slots are filled with conductors (connected in  
 series). In actual practice, only 75 per cent. of the slots  
 are used, and the spread of the single-phase winding will be about  
 135 degrees; the resultant e.m.f. will be  $AB$ , which is  
 shorter than  $AC$ ; but the length and weight of copper  
 are in the proportion  $\frac{\text{arc } AB}{\text{arc } ABC}$ . The fact that,  
 in polyphase machines, the whole of the armature surface is  
 used for the windings, while only a portion of this surface  
 is used in the single-phase alternator, accounts for the fact  
 that the output of the latter is less than that of the polyphase  
 machine for the same size of frame. Given a three-phase machine,  
 it is necessary to omit one of the phase windings entirely

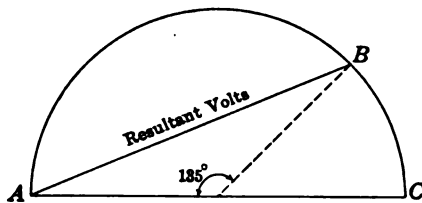

Fig. 98.—Vector diagram illustrating "spread" of armature winding in  
 single-phase alternator.

and connect the two remaining phases in series, to obtain a  
 single-phase generator. The modified machine will be capable  
 of giving something more than two-thirds of the output of the  
 polyphase generator, the limit being reached when the copper  
 losses become excessive.

**80. Insulation of Armature Windings.**—With very high  
 voltages, such as are used on many power transmission schemes,  
 a special study has to be made of the problems of insulation.  
 These problems then become of extreme importance, and many  
 difficulties have to be overcome that do not trouble the designer  
 who is dealing with pressures of the order of 5,000 to 10,000  
 volts.

The reader is referred to Art. 28 of Chap. V, where slot insula-  
 tion was discussed, and since the same insulating materials  
 are used in alternators as in dynamos, there is little to be added  
 here. It is the practice of some manufacturers to have the

question of insulation studied by experts who decide upon the most suitable materials to withstand the particular conditions under which the machine will have to operate, and then advise the designer of the machine regarding the space to be allowed to accommodate this insulation. If high-class insulating materials are used, the slot lining, *i.e.*, the total thickness of insulation between the conductors and the side or bottom of the slot, should have the following values:

Terminal voltage	Thickness of insulation (one side)
500	0.045 in.
1,000	0.060 in.
2,000	0.080 in.
4,000	0.12 in.
8,000	0.19 in.
12,000	0.27 in.

**81. Current Density in Armature Conductors.**—Although the armature may be stationary, the permissible current density in the conductors will depend to some extent upon the peripheral speed of the rotating field magnets, because the fanning effect will be greater at the higher velocities. The cooling effect of the air thrown against the conductors by the rotation of the field magnets is not so great as when the armature rotates, and moreover, the air is warmed to some extent in passing over the heated surface of the field coils. The current density in alternator armatures usually lies between 1,500 and 3,000 amp. per square inch of cross-section. The formula previously used in the design of dynamo armatures requires some modification, and the writer proposes the following empirical formula for current density in the armature windings of alternators with rotating field system, up to a peripheral speed of 8,000 ft. per minute:

$$\Delta = \frac{600,000}{q} + \frac{v}{5} \tag{96}$$

The symbols have the same meaning as in formula (51) on page 97; the peripheral velocity,  $v$ , being calculated by assuming that the armature is rotating instead of the field.

**82. Tooth and Slot Proportions.**—In deciding upon the number of teeth on the armature, a compromise must be made between a very small number of teeth—which involves the bunching of conductors, with consequent high internal



temperatures and high inductance—and a large number of teeth, involving more space taken up by insulation, and a higher cost generally. Although larger slots are permissible in A.C. than in D.C. machines, a slot pitch ( $\lambda$ ) greater than 2.5 in. is not recommended. The upper limit might be 2.75 in. if the air gap is large, while the lower limit is determined by considerations of space available for conductors and insulation, bearing in mind the higher cost of a large number of coils. In large turbo-alternators, the slot pitch may be as large as 3 in. or even  $3\frac{1}{2}$  in. but in such cases a slot wedge built up of laminated iron plates is generally used, thus virtually reducing the slot opening and equalizing the flux distribution over the slot pitch. In a three-phase machine, the number of slots per pole per phase is usually from 1 to 4; but in turbo-alternators, with large pole pitch, the number of slots may greatly exceed these figures.

The conductors must be so arranged that the width of slot is not such as to reduce the tooth section beyond the limit corresponding to a reasonable flux density in the iron of the tooth (see Art. 76 of the preceding chapter); but, on the other hand, a deep slot is sometimes objectionable because it leads to a high value of slot leakage flux. The depth of the slot should preferably not exceed three times the width, although deeper slots can be used, and may, indeed, be desirable in cases where poor inherent regulation is deliberately sought.

**83. Length and Resistance of Armature Winding.**—Apart from the pitch,  $\tau$ , and the gross length of armature core,  $l_a$ , the length per turn of the winding will depend upon the voltage and also upon the slot dimensions. The voltage will determine the amount by which the slot insulation should project beyond the end of the armature core, and the cross-section of the coil will be a factor in determining the length taken up in bends at the corners of the coil. A rough sketch of the coil should be made, and the length of a mean turn estimated as closely as possible for the purpose of calculating the resistance and weight. With the high pressures generated in some machines, it is necessary to carry the slot insulation a considerable distance beyond the end of the slot in order to guard against surface leakage, and although no definite rules can be laid down to cover all styles of winding, the straight projection of the coil-side (and insulation) outside the slot would be at least  $\frac{1}{2}$  (k.v. + 1) in.; where k.v. stands for the pressure between terminals in kilovolts. On

the basis of an average size of slot, the actual overhang beyond end of core would have a mean value of about  $\frac{1}{2} (\text{k.v.} + 3 + \frac{\tau}{4})$ , where  $\tau$  is the pole pitch in inches. On this basis, and as a very rough estimate, the mean length per turn in inches, would be

$$2l_a + 2.5\tau + 2 \text{ k.v.} + 6 \quad (97)$$

The cross-section having been previously decided upon, the resistance per phase of the armature winding can readily be calculated.

**84. Ventilation.**—The gross length of the armature core ( $l_a$  in the last formula) will depend upon the space taken up by the radial vent ducts and insulation between stampings. If radial ducts are used, they are from  $\frac{3}{8}$  to  $\frac{5}{8}$  in. wide, spaced 2 to 4 in. apart, the closer spacing being used when the axial length of the core is great and the peripheral velocity low.

In turbo-alternators, axial vent ducts are being used in place of radial ducts. If there are no radial openings between the armature plates, the length of the core can be reduced, and this is always desirable in high-speed machines. The relation between net and gross lengths of armature core will then be approximately  $l_n = 0.92l_a$ . Even when axial ducts are used, one or more radial openings at the center of the core are sometimes provided so that the cool air may be drawn in at both ends of the armature and discharged at the center. The fan for forced ventilation may be inside or outside the generator. In large units the external fan is generally to be preferred. The reader is referred to Art. 33, Chap. VI, where the ventilation of dynamos was discussed.

**85. Full-load Developed Voltage.**—The losses in the armature core at full load will depend upon the developed e.m.f., which is not quite so easily calculated as in the case of a D.C. dynamo. The pressure that has to be generated in the armature windings of an alternator for a given terminal voltage, will depend not only upon the  $IR$  pressure drop, but also on the  $IX$  drop. In other words, the inductance of the armature windings, and the power factor of the load, must be taken into account when calculating the developed voltage.

The vector diagram, Fig. 99, refers to a machine working on a load of unity power factor. The current is in phase with the terminal voltage  $OE_t$ ; but the developed volts are  $OE_p$  and not

$OP$  as would be the case if the  $IR$  drop only had to be considered. The vector  $PE_g$  represents the e.m.f. component necessary to counteract the reactance drop in the armature windings. Although the external power-factor angle is zero, there is an angle  $\psi$  between the current vector and the vector of the developed e.m.f., which may be termed the internal power-factor angle.

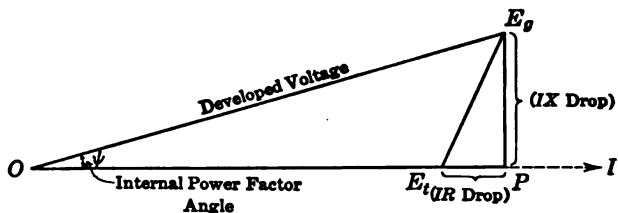

FIG. 99.—Vector diagram for calculating developed e.m.f.—non-inductive load.

In Fig. 100, the external power-factor angle is  $\theta$  (power factor of load =  $\cos \theta$ ). The construction shows how the reactance voltage ( $IX$ ) becomes a factor of greater importance on the lower power factors. The e.m.f. that must be developed to obtain a constant terminal pressure must, therefore, be greater on low power factor. This, however, is not the chief cause of poor regulation on low power factors; it is the demagnetizing effect of

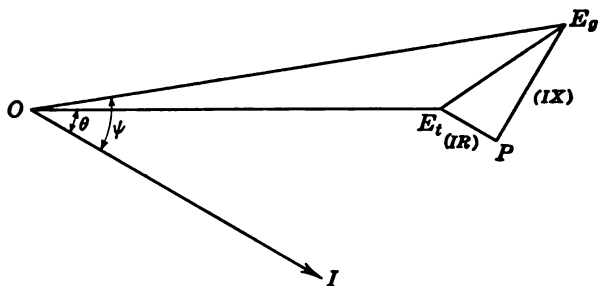

FIG. 100.—Vector diagram for calculating developed e.m.f.—load partly inductive.

the armature ampere-turns which is chiefly accountable for poor regulation on all but unity power factor. From an inspection of Fig. 100 it will be seen that the greatest difference between developed and terminal voltage occurs when the external power-factor angle is the same as the angle  $E_gE_tP$ , because the developed voltage is then simply the arithmetical sum of the terminal voltage  $OE_t$  and the impedance drop  $E_gE_t$ .



In connection with the predetermination of temperature rise, the losses in the armature core may well be calculated on the assumption that this condition is fulfilled.

The vector diagrams should always be drawn to show the relation of the variable quantities in *one phase of the winding*; a balanced load being assumed. It does not then matter whether the phases are star- or delta-connected, except that, in the case of a star-connected generator, the vector  $OE_t$  would stand for the voltage between one terminal and the neutral point, and its numerical value would therefore be  $\frac{1}{\sqrt{3}}$  times the voltage between terminals.

The length of the vector  $E_tP$  in Figs. 99 and 100 is easily calculated; but the numerical value of  $IX$  (the vector  $PE_g$ ) is not so easily estimated. Consider first what is to be understood by the term armature reactance.

**86. Inductance of A.C. Armature Windings.**—It is not always easy to separate armature reactance ( $X$ ) from armature reaction (the demagnetizing effect of the armature ampere-turns). Both cause a drop of pressure at the terminals under load, especially on low power factors. By departing from the conventional methods of treating this part of the subject, and striving to keep in mind the actual physical conditions, by picturing the armature conductors cutting through the flux lines, it is hoped that the difficulties of the subject may, to a great extent, be removed.

The inductance of the windings, in so far as it affects regulation, will be taken up again in Chap. XIV, and for our present purpose—which is mainly to design an armature that shall not attain too high a temperature—it is not proposed to add much to what was said in Chap. VIII when treating of the flux cut by the coil undergoing commutation. A distinction was then made between the slot flux and the end flux. The same conditions are met with in the alternator, where what is usually referred to as the reactive voltage component (the vector  $E_gP$  in Figs. 99 and 100) is really due to the cutting of the end flux by the conductors projecting beyond the ends of the slots: the slot flux, being actually provided by the main poles, does not enter the armature core below the teeth, and since it is not cut by the armature inductors, it should not be thought of as producing an e.m.f. of self-induction in the windings. The slot

flux may be considerable, especially on a heavy load of low power factor, and it will have an appreciable effect on the inherent regulation of the machine. The m.m.f. of the conductors in the slot accounts for the fact that a certain percentage of the flux in the air gap does not enter the armature core below the teeth; but the point here made is that the slot leakage flux does not induce a counter e.m.f. in the armature windings.

The core loss will depend upon the flux necessary to develop the e.m.f.  $OE_0$  of Figs. 99 and 100, where the component  $E_0P$  is the reactance voltage drop due to the flux linkages of the end connections only; or, in other words, where  $E_0P$  is the e.m.f. induced in the conductors outside the slots by the cutting of the flux lines created by the currents in all the phase windings.

**87. Calculation of Armature Inductance.**—The flux cut by the conductors which project beyond the ends of the armature slots is very difficult to calculate, and empirical formulas based

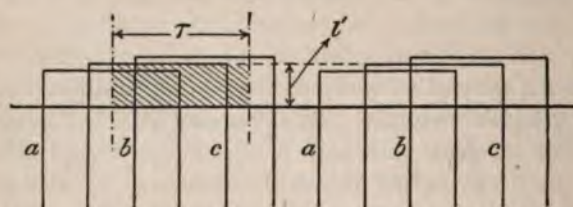

Fig. 101.—Illustrating flux cut by end projections of armature coils.

on experimental data are generally used for predicting the probable value of the inductance of the armature end connections. In Fig. 101 let  $\tau$  represent the pole pitch of a three-phase generator and  $l'$  the average axial extension of the coils beyond the ends of the armature core.<sup>1</sup> If the total flux produced by the armature currents, in the space  $\tau$  cm. wide by  $l'$  cm. deep, as shown cross-hatched in Fig. 101, can be estimated, the voltage developed by the cutting of this flux can readily be calculated. Without attempting to go into the niceties of mathematical analysis—which would apply only to one of the many different arrangements of coils—it can be shown that the flux produced through

<sup>1</sup> The equivalent projection of a coil that is bent up to clear the coils of other phases might be considered equal to the projection of the same coil if flattened out. With  $\tau$  expressed in inches, an approximate value for  $l'$ , based on the assumptions made in Art. 83, is

$$l' = 1.27 \left( \text{k.v.} + 3 + \frac{\tau}{4} \right) \text{ cm.}$$



air paths by the currents in the axial prolongations of the slot conductors will depend mainly upon the number of ampere-conductors per pole on the armature, and on the amount of the projection  $l'$ . There will be no exact proportionality between ampere-conductors per pole and flux, the relation being a logarithmic function of the pole pitch  $\tau$  and dependent on the number of slots, *i.e.*, whether the winding is concentrated or distributed. The flux produced by the connections running approximately parallel to the circumference of the armature will depend not only on  $\tau$  but also on  $l'$ . Thus, the amount of the projection  $l'$  beyond the ends of the slot would seem to be a more important factor than the circumferential width of the coils in determining the end flux, and for the calculation of the total end flux per pole (both ends) in the case of a three-phase generator the writer suggests the empirical formula

$$\Phi_e = kT_s I_c l_e \frac{6}{n_s + 5} \log_{10} (12n_s l') \quad (98)$$

where  $T_s$  = the number of inductors in each slot.

$n_s$  = the number of slots per pole per phase.

$l'$  = the projection of coil-ends beyond end of slots, in centimeters.

$l_e = (2\tau + 4l')$  = approximately the total length in centimeters per turn of wire in a coil, less the slot portion.

$I_c$  = the armature current per conductor (r.m.s. value).

$k$  = constant, approximately unity, depending upon the design of the machine, the arrangement of the windings, and the proximity of masses of iron tending to increase the induction.

The quantities  $6/(n_s + 5)$  and  $\log_{10} (12n_s l')$  are factors introduced mainly to correct for the increase of flux with a concentrated winding, and for the fact that the projection  $l'$  of the coils will influence the total flux to a greater extent than the end length  $\tau$  which appears in the expression for the total length  $l_e$ .

If  $p$  is the number of poles of the machine, the total number of conductors per phase is  $pT_s n_s$ , and the average value of the voltage developed in the end connections by the cutting of the end flux will be  $2f\Phi_e pT_s n_s \times 10^{-8}$ . Assuming the form factor to be 1.11, which would be correct if the flux distribution were sinusoidal, and substituting for  $\Phi_e$  the value given by formula

(98), the voltage component developed per phase winding by the cutting of the end flux is

$$E_e = (2.22k)fpT_s^2l_e \left( \frac{6n_s}{n_s + 5} \right) \log_{10} (12n_s l') \times I_e \times 10^{-8} \quad (99)$$

This quantity is usually referred to as the reactive voltage drop per phase due to the inductance of the end connections; it appears as the vector  $PE_e$  in Figs. 99 and 100. If the multiplier  $(2.22k)$  be taken as 2.4, the formula agrees well with the average of tests on machines of normal design.

**88. Total Losses to be Radiated from Armature Core.** —The losses in the iron stampings—teeth and core—are calculated as explained in Chap. VI (Art. 31). The flux to be carried at full load by the core below the teeth is that which will develop the necessary e.m.f. as obtained from the vector construction of Fig. 100. The radial depth of the armature stampings is calculated by assuming a reasonable flux density in the iron. This will usually be between 7,000 and 8,500 gausses in 60-cycle machines, increasing to 10,000 or even 11,000 in 25-cycle generators.

The permissible density in the teeth, as previously mentioned, rarely exceeds 16,000 gausses at 60 cycles and 18,000 gausses at 25 cycles. Higher densities may have to be used occasionally, but special attention must then be paid to the methods of cooling, in order to avoid excessive temperatures. The tooth density being appreciably lower than in D.C. machines, the apparent flux density at the middle of the tooth may be used for estimating the watts lost per pound. The maximum value of the tooth density will depend upon the maximum value of the air-gap density, and this, in turn, is modified by armature distortion and slot leakage. The flux that must enter the core and be cut by the armature inductors is known, but the amount of flux entering the teeth under each pole face is greater, since it includes the slot leakage flux in the neutral zone, the amount of which depends not only upon the current in the armature, but also upon its phase displacement, *i.e.*, upon the power factor of the load. Then, again, the maximum value of the air-gap flux density depends not only upon the average density, but also on the shape of the flux distribution over the pole pitch. It will not be necessary to go into details of this nature for the purpose of estimating the temperature rise of the armature, and a sinusoidal



flux distribution may be assumed, making the maximum air-gap density  $\frac{\pi}{2}$  times the average value over the pole pitch. The calculation of slot leakage flux will be explained later, and its effect may for the present be neglected.<sup>1</sup>

As a check on the calculated core loss, the figures of Art. 32 (page 104) may be used; but these values will depend upon whether the copper or the iron losses are the more important, *i.e.*, on the relative proportions of iron and copper in the machine. Iron losses 50 per cent. in excess of the average values given on page 104 would not necessarily betoken inefficiency or a high temperature rise.

When computing the total losses to be carried away in the form of heat from the surface of the armature core, the whole of the copper loss should not be added to the iron loss, but only the portion of the total  $I^2R$  loss which occurs in the buried part of the winding, *i.e.*, in the "active" conductors of length  $l_a$ . In the case of large machines, it may be necessary to make some allowance for eddy-current loss in the armature conductors. This loss might be considerable if solid conductors were used; but it is usual to laminate the copper in the slot so that the eddy-current loss due to the slot flux is very small. This point must not, however, be overlooked in large units; and special means may have to be adopted to avoid eddy-current loss in the armature conductors.

**89. Temperature Rise of Armature.**—The probable temperature rise of the armature is estimated as explained in Art. 34 of Chap VI, in connection with the design of D.C. dynamos. The cooling surfaces are calculated in a similar manner; but with the stationary armature and internal rotating field magnets, the belt of active conductors is the *inside* cylindrical surface of the armature; and this is cooled by the air thrown against it by the fanning action of the rotor. The cooling coefficient, containing the factor  $v$  (the peripheral velocity), may be used, just as if the armature were rotating instead of the field magnets. The external cylindrical surface of the armature core will have no air blown against it (in the self-ventilating machine), and the value of  $v$  in the formula will be zero. In regard to the radial

<sup>1</sup> The amount of the slot leakage flux, expressed as a percentage of the total flux per pole, becomes of importance in well-designed machines only when the pole pitch is very small.

vent ducts, the cooling is not quite so good as when the armature rotates, but a blast of air is driven through the ducts, and this is effective in carrying off the heat. The difficulty in determining cooling coefficients that shall be applicable to all sizes and types of machine stands in the way of obtaining great accuracy in the calculation of temperature rise. It is, however, suggested that the formulas (53) and (55) of Art. 34 (page 110) be used, and that the temperature rise as calculated by the application of these formulas be increased 20 per cent. A temperature rise of  $45^{\circ}$  is usually permissible.

In designing steam-turbine-driven machines with forced ventilation, the quantity of air required to carry off the heat losses must be estimated (see Art. 34, page 112) and the size and configuration of the various air passages must be carefully studied with a view to preventing very high air velocities and consequent increase of loss by friction. The average velocity of the air through the ducts of machines provided with forced ventilation is usually between 1,500 and 4,000 ft. per minute. This velocity should preferably not exceed 5,000 ft. per minute; it is usually possible to keep within this limit by carefully designing the system of ventilation.

High-speed machines such as turbo-alternators, when provided with forced ventilation, are usually totally enclosed, the air passages being suitably arranged to prevent the outgoing (hot) air being mixed with the incoming (cool) air. Large ducts must be provided for conveying the air to and from the machine. A safe rule is to provide ducts or pipes of such a cross-section that the mean velocity of the air will not exceed 2,000 ft. per minute.

## CHAPTER XIII

### AIR-GAP FLUX DISTRIBUTION—WAVE SHAPES

**90. Shape of Pole Face.**—When an alternator is provided with salient poles, the open-circuit flux distribution over the pole pitch can be made to approximate to a sine curve by suitably shaping the pole face. One method of increasing the air-gap reluctance from the center outward is illustrated in Fig. 102. The “equivalent” air gap,  $\delta_e$ , at center of pole face is calculated as explained in Art. 36 of Chap. VII (formula 58), and the

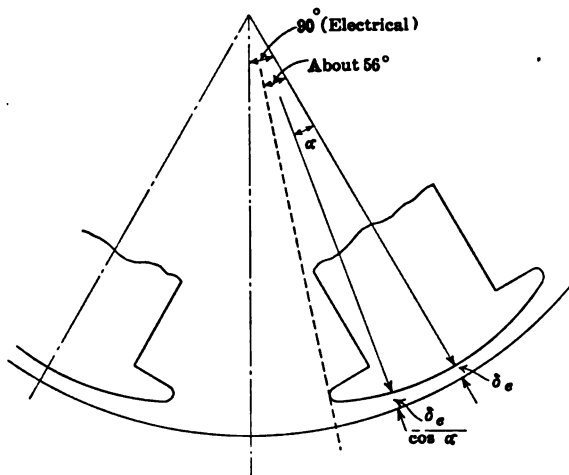

FIG. 102.—Method of shaping pole face of salient pole alternator.

equivalent gap at any other point under the pole is made equal to  $\frac{\delta_e}{\cos \alpha}$  where  $\alpha$  is the angle (electrical space degrees) between the center of pole and the point considered. The pole face would extend about 56 degrees on each side of the center, the pole tips being rounded off with a small radius. In practice the curve of the pole face would probably not conform exactly with this cosine law; it would generally be a circular arc, not concentric with the bore of the armature, but with the center displaced so



that the air gap near the pole tip would be approximately as determined by the method here described.

With the cylindrical field magnet it is not usual to shape the pole face. The clearance between the tops of the teeth on armature and rotor would have a constant value, the proper distribution of flux over the armature surface being obtained by spreading the field coils over the periphery of the cylindrical rotor. From 15 to 25 per cent. of the pole pitch is left unwound at the center of the pole. This unwound portion is usually slotted, but it can be left solid if it is desired to reduce the re-

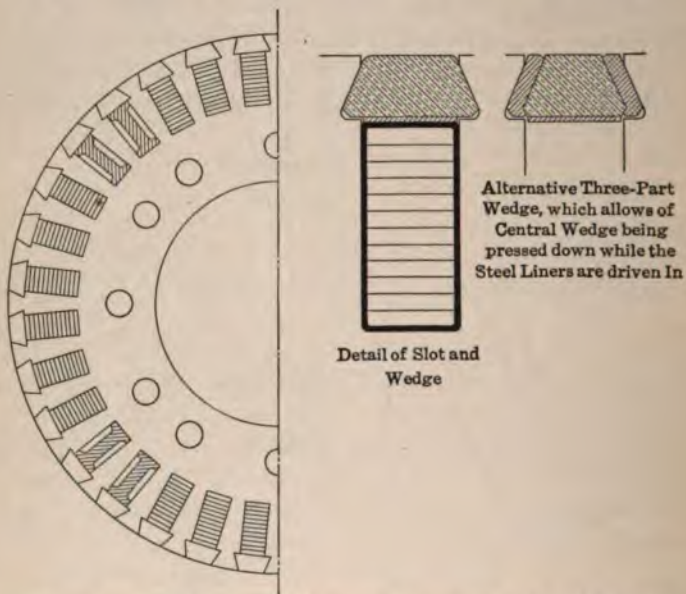

FIG. 103.—Rotor of four-pole turbo-alternator, with radial slots.

luctance of the air gap at the center of the pole face while yet retaining the cylindrical form of rotor. One advantage of equally spaced slots over the surface of the rotor is that there are no sudden changes in the air-gap permeance—the average value of which is then the same at all points on the periphery—and another argument in favor of slotting the unwound portion of the pole face is that the field may be “stiffened” by using high flux densities in the teeth.

Fig. 103 is a section through part of the rotor of a four-pole turbo-alternator. The rotor of a two-pole machine may

be constructed in the same way, with radial slots, but parallel slots as shown in Fig. 104 are sometimes used. The calculation of windings for the cylindrical type of field magnet will be taken up in Art. 93.

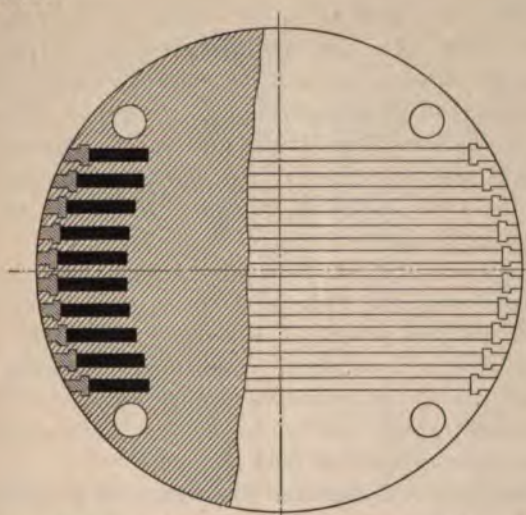

FIG. 104.—Rotor of two-pole turbo-alternator, with parallel slots.

**91. Variation of Permeance over Pole Pitch—Salient-pole Machines.**—The curve representing the variations of permeance between pole face and armature core over the entire pole pitch, can be drawn exactly as in the case of the D.C. design. This was explained in Arts. 39 and 41 of Chap. VII. The pole shoe in Figs. 42 and 43 is shaped in accordance with the cosine law as explained in the preceding article, and the flux lines in Fig. 43 are therefore such as would enter the armature of a salient-pole alternator on open circuit. The practical construction of Fig. 45 has been carried out on a pole of similar shape, and nothing more need be added here concerning the manner of plotting a permeance curve similar to the one shown in Fig. 44.

The effect of tooth saturation may be dealt with also as in the D.C. design (Art. 42), and a set of curves such as those of Fig. 49 should be drawn. On account of the higher frequencies, the tooth densities are lower in A.C. than in D.C. machines, and the effect of saturation of the armature teeth is therefore less noticeable.



**92. M.m.f. and Flux Distribution on Open Circuit—Salient-pole Machines.**—The procedure here is still the same as in D.C. design, and the reader is referred to Arts. 40, 41, and 42, of Chap. VII.

In deriving the curve of m.m.f. from the open-circuit flux distribution curve (*A*), the modified method, as explained in Chap. X under items (72) to (76), may be used. This short cut is permissible in predetermining the air-gap flux distribution of almost any alternating-current generator, because, as previously mentioned, the effect of low flux densities in the teeth is to discount their influence on the distribution of the flux density over the armature surface.

By carefully shaping the pole face, a sinusoidal distribution of flux density over the armature surface can be obtained *on open circuit*; but the design of a salient-pole machine to give a sine wave of e.m.f. under all conditions of loading involves other factors, and is by no means a simple matter. The effect of the armature m.m.f. will be considered after taking up the special case of the cylindrical field magnet.

**93. Special Case of Cylindrical Field Magnet with Distributed Winding.**—In the case of a slotted rotor carrying the field coils, and an air gap of constant length—due to the fact that the bore of the stator or armature is concentric with the (cylindrical) rotor—the shape of the m.m.f. curve due to field excitation alone can readily be found without resorting to the somewhat tedious process of getting the permeance between pole and armature points, as described and recommended for salient-pole machines.

If the whole surface of the rotor is provided with equally spaced slots, the average permeance of the air gap between stator and rotor will have a constant value for all points on the armature periphery. This condition is represented in Fig. 105, if the center portion of the pole, of width *W*, is slotted as indicated by the dotted lines. This constant average air-gap permeance can be calculated within a close degree of approximation by making conventional assumptions in regard to the path of the magnetic lines, as was done in the case of the salient-pole machines when deriving formula (57) (page 117) giving the permeance at center of pole. The flux lines can be supposed to be made up of straight lines and quadrants of circles; and if the permeance over one tooth pitch is worked out for different relative positions of field and armature, very satisfactory results can be obtained

by this method. It will usually suffice to make the calculations for one tooth pitch in the position of greatest permeance, and again in the position of least permeance. The average of these calculated values, divided by the area of the tooth pitch in square centimeters, will give the average value of the air-gap permeance per square centimeter.

Under this condition of constant air-gap permeance, the flux distribution on open circuit will follow the shape of the m.m.f. curve; but, in any case, since  $B = \text{m.m.f.} \times \text{permeance per square centimeter}$ , the flux curve can always be obtained when the m.m.f. distribution is known. Thus, if the portion  $W$

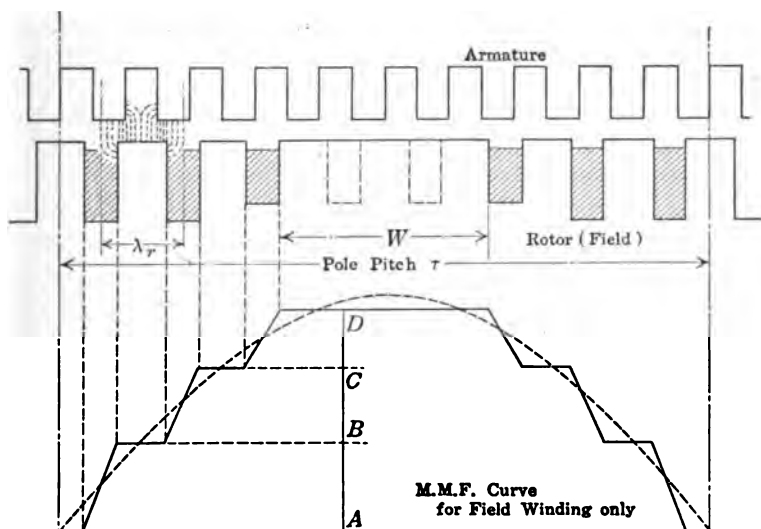

FIG. 105.—M.M.F. over pole pitch, due to distributed field winding.

of the pole (Fig. 105) is not slotted, the permeance curve, instead of being a straight line of which the ordinates are of constant value, would be generally as shown in Fig. 106. From these values of the permeance per square centimeter of armature surface, curves such as those of Fig. 49 (page 133) can be drawn, so as to include the reluctance of the armature teeth. From all points on the armature between  $A$  and  $B$ , and  $C$  and  $D$  (Fig. 106), the average air-gap permeance would have the value  $AA'$ . Over the central portion  $W$  it would have the value  $EE'$ , while, in the neighborhood of the points  $B$  and  $C$ , it may be assumed to have an intermediate value as indicated by the ordinate  $BB'$ .

If the depth of the slots in the rotor has been decided upon and the number of ampere-conductors in each slot determined, the distribution of m.m.f. over armature surface due to the field winding can readily be plotted as in the lower sketch of Fig. 105. Thus the ampere-turns in the coil nearest the neutral zone are represented by the height  $AB$ , those in the middle coil by  $BC$ , and those in the smallest coil by  $CD$ . The broken straight line so obtained is best replaced by the dotted curve, which takes care of fringing, and represents the average effect. This curve, being the open-circuit distribution of m.m.f. over armature surface for a given value of exciting current, may be combined with the curve of armature m.m.f. to obtain the resultant m.m.f. under loaded conditions. The flux curves for open-circuit and loaded conditions can then be derived by proceeding exactly as in the case of the salient-pole designs.

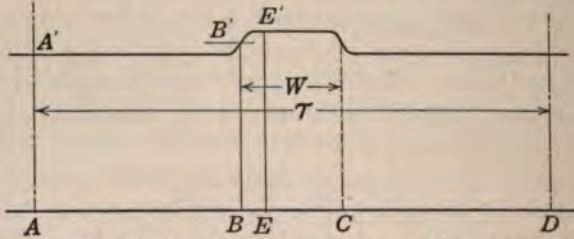

FIG. 106.—Distribution of air-gap permeance in turbo-alternator when unwound portion of pole face is not slotted.

With salient-pole machines variations in the open-circuit flux distribution can be obtained only by shaping the pole shoes so as to alter the air gap over the pole pitch in a manner which is not easily determined except by trial, but with the field winding distributed in slots it is not difficult to arrange the coils to give any desired distribution of m.m.f. over the pole pitch. Thus, if the desired flux curve is known (a sinusoidal distribution is usually best for alternating-current machines), and if the average permeance per square centimeter of the air gap has been calculated, an ideal m.m.f. curve can easily be drawn, since, at every point, the m.m.f. is the ratio of the flux density to the permeance per square centimeter. The spacing and depth of slots can then be arranged to produce a magnetizing effect as nearly as possible the same as that of the ideal curve.

**94. Armature M.M.F. in Alternating-current Generators.**—In a continuous-current machine the current has the same value



at all times in all the armature conductors, and equation 65 (page 136) shows how the armature m.m.f. follows a straight-line law over a zone equal to the pole pitch, this being the distance between brushes referred to armature surface. In alternating-current and polyphase generators the curve of armature m.m.f. can no longer be represented graphically by straight lines as in Fig. 53, because the value of the current will not be the same in all the conductors included in the space of a pole pitch.

Considering first the polyphase synchronous generator, and assuming a sinusoidal current wave, it is an easy matter to draw a curve representing the armature m.m.f. at any particular instant of time, provided the phase displacement—or position of the conductors carrying the maximum current—relatively to center line of pole is known. If this be done for different time values, a number of curves will be obtained, all consisting of straight lines of varying slopes, the length of which relatively to the pole pitch will depend on the number of phases for which the machine is wound. The average of all these curves will be a sine curve of which the position in space relatively to the poles is constant, and exactly 90 electrical space degrees behind the position of maximum current.

The method of drawing the curve of armature m.m.f. for any instant of time, is illustrated in Fig. 107, where the upper diagram shows the distribution of m.m.f. over the armature periphery of a three-phase generator at the instant when the current in phase (2) has reached its maximum value. If the power factor is unity (load non-inductive), the current maximum will occur simultaneously with the voltage maximum, *i.e.*, when the belt of conductors is under the center of the pole face, as shown in the diagram. A low power factor would cause the current to attain its maximum value only after the center of the pole has travelled an appreciable distance beyond the center of the belt of conductors, and this effect will be explained later; at present we are concerned merely with the distribution, and magnitude, of the armature m.m.f. The vector diagram on the right-hand side of the (upper) figure shows how the value of the current in phases (1) and (3), at the instant considered, will be exactly half the maximum value; and the magnetizing effect of phase (1) or (3) is therefore exactly half that of phase (2). The angle of 60 degrees between vectors representing three-phase currents—with a phase displacement at terminals of 120 degrees—is

accounted for by the fact that the angular displacement between adjoining belts of conductors is only  $\frac{180}{3} = 60$  electrical degrees; but the connections between the phase windings are so made as to obtain the phase difference of 120 degrees between the respective e.m.fs. Thus, the reversal of the vector (1) in the

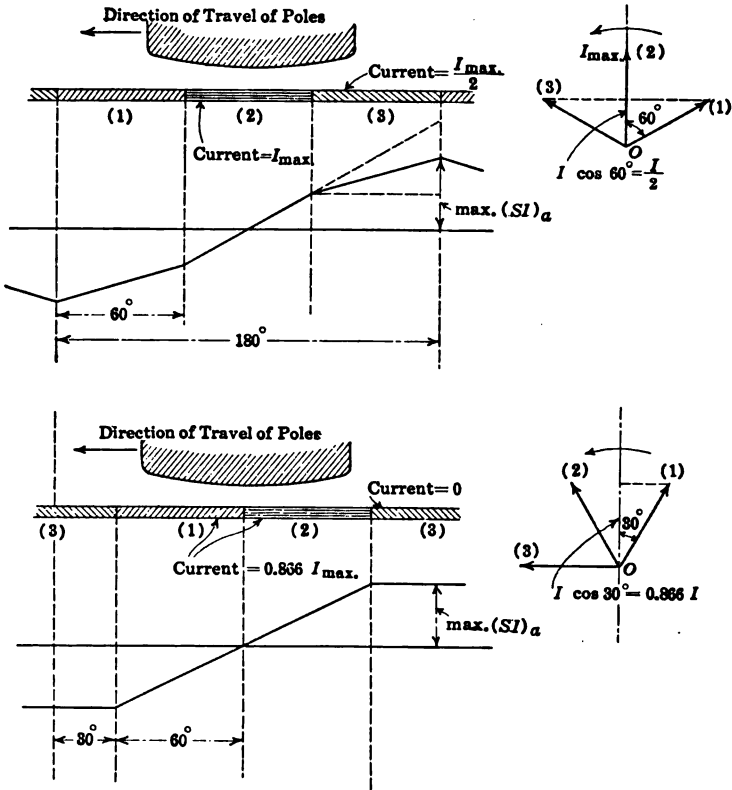

FIG. 107.—Instantaneous values of armature m.m.f. in three-phase generator.

diagram would cause it to lead vector (2) by 120 degrees instead of lagging behind by 60 degrees; and the reversal of the vector (3) would cause it to be 120 degrees behind (2) instead of 60 degrees ahead.

The lower diagram of Fig. 107 shows the armature m.m.f. one-twelfth of a period later, *i.e.*, when the poles have moved to the left (or the conductors to the right) 30 electrical space de-

grees. The current in phases (1) and (2) now has the instantaneous value  $i = I_{max} \cos 30 = 0.866I_{max}$ ; while the current in (3) is zero. If several curves of this kind are drawn, it will be found that the instantaneous values of m.m.f. at any point on the armature periphery (considered relatively to the poles) differs very little from the average value; in other words, the pulsations of flux due to cyclic changes in the m.m.f. will, in a three-phase machine, be negligibly small. For this reason, and also in order to shorten and simplify the work, the armature m.m.f. of a polyphase generator may conveniently be studied by assuming a large number of conductors, and a number of phases equal to

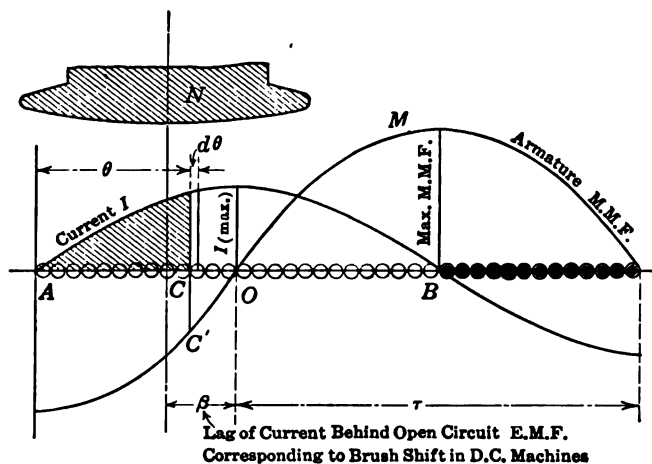

FIG. 108.—Method of obtaining armature m.m.f. curve from curve of current distribution.

the number of conductors in the space of one pole pitch. Thus, the ordinates of curve  $I$  of Fig. 108 (assumed to be a sine curve) give the value of the current in the various conductors distributed over the armature surface. It is understood that the current in each individual conductor varies according to the simple harmonic law; but it is constant in value for a given position on the armature surface considered relatively to the poles. The direction of the current in the conductors between the points  $A$  and  $B$  may be considered as being downward, while the direction of the current in the adjoining section of width  $\tau$  would be upward. The maximum value of the armature m.m.f., therefore, occurs at the point  $B$ , and we may write:

Maximum value of armature ampere-turns per pole = average value of current in section  $OB \times$  number of turns, or

$$(SI)_a = \frac{2}{\pi} I_{max} \times \frac{Z'}{2p} \quad (100)$$

where  $Z'$  stands for the total number of inductors on the armature periphery. This may be compared directly with formula 66 (page 136), which applies to direct-current machines, by putting it in the form

Max. m.m.f. (gilberts) per pole

$$\begin{aligned} &= \frac{0.4\pi \times 2 \times I_c \sqrt{2Z'}}{\pi \times 2p} \\ &= \frac{0.4\pi Z' I_c}{1.11 \times 2p} \end{aligned} \quad (101)$$

where  $I_c$  stands for the virtual or r.m.s. value of the current in the armature conductors.

That the armature m.m.f. curve in Fig. 108 is also a sine curve when the current follows the sine law is easily seen from the general solution, thus:

The magnetizing effect of the conductors in the small space of width  $d\theta$  is

$$I_{max} \sin \theta \times \frac{Z'}{p} \frac{d\theta}{\pi}$$

wherein  $I_{max} \sin \theta$  is the current per conductor, and  $\frac{Z'}{p} \frac{d\theta}{\pi}$  is the number of conductors in the space considered (the angle  $\theta$  being expressed in radians).

The expression for the total ampere-conductors is therefore

$$I_{max} \frac{Z'}{p\pi} \Sigma \sin \theta d\theta$$

With an increase in the number of inductors (and phases) this quantity approaches more and more nearly the definite integral, *i.e.*, the area of the current curve, as indicated by  $CC'$  in Fig. 108 being a measure of the shaded portion of the curve  $I$ ; and we can then write

$$\begin{aligned} \text{Armature ampere-conductors} &= I_{max} \frac{Z'}{\pi p} \int \sin \theta d\theta \\ &= - I_{max} \frac{Z'}{\pi p} \cos \theta + C \end{aligned}$$



the maximum value of which occurs when  $\theta = 0$  and  $\theta = \pi$ . The constant of integration merely determines the position of the datum line; and since we have symmetry and equal strength of North and South poles, we can put  $C = 0$  and write for the maximum value of the armature ampere-turns per pole,

$$(SI)_a = \frac{Z'}{\pi p} I_{max} = \frac{\sqrt{2}Z'}{\pi p} I_c \text{ which checks with formula (100).}$$

The angle of displacement  $\beta$  (Fig. 108) of this curve relatively to the center line of pole depends upon the "internal" power factor, and also upon the displacement of the wave of developed e.m.f., a displacement or distortion which is due to cross-magnetization. The angle  $\beta$  is not very easily predetermined, but, once known or assumed, the curve  $M$  can be drawn in the correct position relatively to the curve of field m.m.f.; and the resultant m.m.f. over the armature surface can be obtained exactly as for the direct-current machine (see Fig. 53, page 137). An approximate method of predetermining the displacement angle  $\beta$  for any load and power factor will be explained in Art. 98.

*Armature M.M.F. Curve of Single-phase Alternator.*—When single-phase currents are taken from an armature winding, the m.m.f. due to this winding as a whole must necessarily be of zero value at the instant of time when the current is changing from its positive to its negative direction. This suggests that the magnetizing effect of the loaded armature will be pulsating; that is to say, it cannot be of constant strength at any given point considered relatively to the poles, whatever may be the phase displacement of the current relatively to the developed voltage. If the change of current in any given conductor be considered over a complete cycle, and if at the same time the position of this conductor relatively to the poles be noted, it will be seen that, *relatively to the field magnet system*, the armature windings produce a pulsating field of double the normal frequency. The actual flux component due to the armature currents will not, however, pulsate to any appreciable extent, because the tendency to vary in strength at comparatively high frequencies is checked by the dampening effect of the field coils, even if the pole shoes and poles are laminated.

No modern single-phase alternator, unless of very small size, should be built without amortisseur windings, or damping grids. These consist of copper conductors in holes or slots, running parallel to the shaft, in the faces of the field poles. They are

joined together at both ends by heavy copper connections, and form a "squirrel cage" of short-circuited bars which damp out the flux pulsations, and also prevent the sweeping back and forth, or "swinging," of the armature flux due to "hunting" when synchronous alternating-current machines are coupled in parallel.

Returning to the magnetizing effect of the single-phase armature, it is, therefore, the average or resultant armature m.m.f. considered relatively to the poles with which we are mainly concerned. The most satisfactory way of studying an effect of this kind is to draw the actual m.m.f. curves at definite intervals of

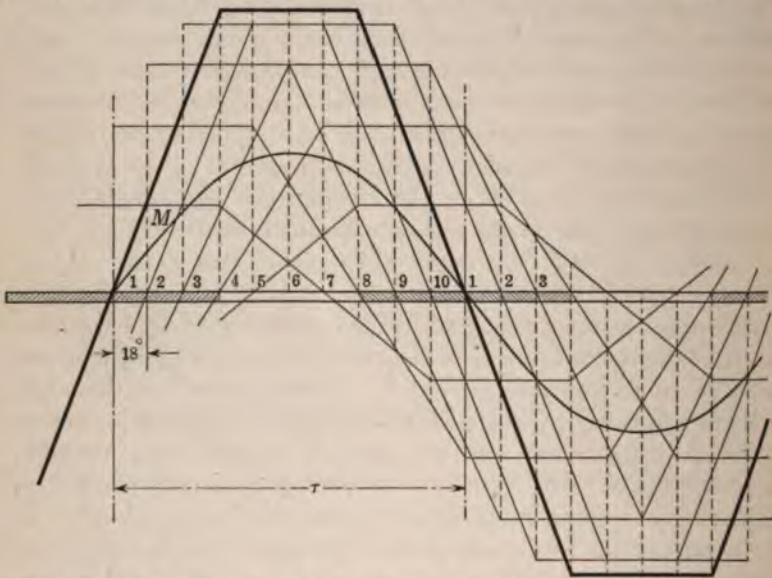

FIG. 109.—Instantaneous and average values of armature m.m.f. in single-phase alternator.

time, and then average the values so obtained for different points on the armature surface, the position of these points being considered fixed relatively to the field poles.

This has been done in Fig. 109, where the windings are shown covering 60 per cent. of the armature surface, and the distance  $\tau$  is one pole pitch. This distance is divided into 10 equal parts, each corresponding to 18 electrical degrees. The thick line represents the armature m.m.f. when the current has reached its maximum value. The armature is then supposed to move 18 degrees to the right of this position, and a second m.m.f. curve is



drawn, corresponding to this position of the windings. Its maximum ordinate is, of course, less than in the case of the first curve, because the current (which is supposed to follow the sine law) now has a smaller value. This process is repeated for the other positions of the coil throughout a complete cycle, and the resultant m.m.f. for any point in space (*i.e.*, relatively to the poles, considered stationary) is found by averaging the ordinates of the various m.m.f. curves at the point considered. In this manner the curve  $M$  of Fig. 109 is obtained. It is seen to be a sine curve, of which the maximum ordinate is half the instantaneous maximum m.m.f. per pole of the single-phase winding, and it may be used exactly in the same way as the curve  $M$  in Fig. 108 (representing armature m.m.f. of a polyphase machine); that is to say, it can be combined with the field pole m.m.f. curve to obtain the resultant m.m.f. at armature surface from which can be derived the flux distribution curves under loaded conditions.

The maximum value of the resultant ampere-turns per pole is, therefore,

$$\frac{1}{2}I_{max} \times \frac{Z}{2p} = I_{max} \times \frac{Z}{4p} \quad (102)$$

where  $Z$  is the total number of armature face conductors. Expressed in gilberts the formula is,

$$\left. \begin{array}{l} \text{Maximum ordinate of armature m.m.f.} \\ \text{curve in single-phase alternator.} \end{array} \right\} = \frac{0.4\pi\sqrt{2}I_c Z}{2 \times 2p} = \frac{0.4\pi Z I_c}{\sqrt{2} \times 2p} \quad (103)$$

which, together with formula (102), may be compared with the formula (100) and (101) for polyphase generators.

**95. Slot Leakage Flux.**—Referring again to Fig. 108, if we wish to derive a curve of resultant m.m.f. over the armature periphery for any condition of loading, it will be necessary, before combining the curves of armature and field pole m.m.f., to determine the relative positions of these two curves. In the direct-current machine, the position of maximum armature m.m.f. coincides with the brush position; but the point  $B$  in Fig. 108 is not so easily determined. Its distance from the center of the pole is  $\beta + 90^\circ$ , a displacement which depends not only on the power factor of the load (*i.e.*, on the lag of the current behind the terminal potential difference), but also on the strength of the field relatively to the armature, because this

relation determines the position (relatively to the center of the pole) of the maximum e.m.f. developed in the conductors.

The field m.m.f. will depend upon the flux in the air gap, and since this includes the slot leakage flux, it will be necessary to consider the meaning, and determine the value, of the slot flux before attempting to calculate the angle  $\beta$  of Fig. 108.

Apart from the action of the armature winding as a whole, causing a reduction of the total flux crossing the air gap from pole face to armature teeth, the current in the individual conductors, by producing a leakage of flux in the slots themselves, still further reduces the useful flux when the machine is loaded. The whole of the flux entering the tops of the teeth is not cut

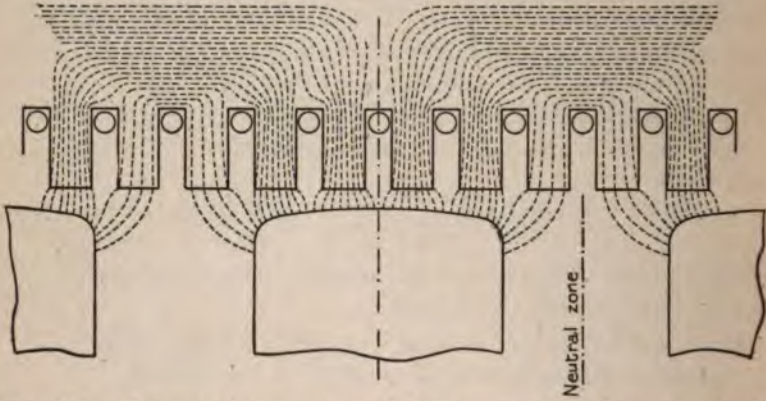

FIG. 110.—Flux entering armature of A.C. generator under open circuit conditions.

by the conductors buried in the slots, and the voltage actually developed in the "active" portion of the armature windings will be reduced in proportion to the amount of flux which, instead of entering the armature core, is diverted from tooth to tooth. This loss of voltage is usually attributed to the reactance of the embedded portion of the windings, and is referred to as a reactance voltage. This term, however, although very convenient, is liable to lead to confusion when an attempt is made to realize the physical meaning of armature reactance. It suggests that a certain electromotive force is generated in the conductors, thus causing a flow of current which, in turn, produces the flux of self-induction and a reactive electromotive force. This is incorrect and leads to a mistaken estimate of the actual amount of



flux in the armature core—a mistake of little practical import yet tending to obscure the issue when considering the problem of regulation, and standing in the way of a clear conception of the flux distribution in the air gap.

The effect of the current in the buried conductors will be understood by comparing Figs. 110 and 111, where the dotted lines indicate roughly the paths taken by the magnetic flux under open-circuit conditions (Fig. 110) and under load conditions (Fig. 111). In the first case, when no current flows in the armature conductors, the whole of the flux entering the tops of the teeth passes into the armature core and is cut by all the conductors. In the second case the magnetomotive force due to the

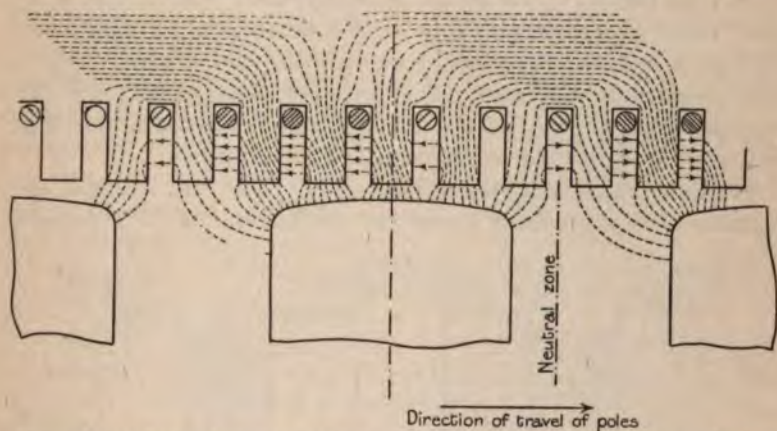

FIG. 111.—Flux entering armature of A.C. generator when the conductors are carrying current.

armature current diverts a certain amount of flux from tooth to tooth, which since it does not enter the armature core is not cut by all the conductors. This conception of the slot flux, as that portion of the total flux leaving the pole shoe, which crosses the air gap but does not enter the armature core below the teeth, disposes of the difficulties encountered by many engineers when faced with the necessity of calculating the slot inductance. It is unnecessary to consider the leakage flux in the slots under the pole face, but it is important to know the amount of flux in the neutral zone,<sup>1</sup> which passes from tooth to tooth and generates no

<sup>1</sup>By neutral zone is meant the space between poles on the armature surface where the lines of magnetic flux are parallel to the direction of travel of the conductors.

electromotive force in the conductors. If this leakage slot flux (in the neutral zone) were actually cut by the conductors, it would generate a component of electromotive force lagging one-quarter period behind the main component (on the assumption of sine-wave form), and it can therefore conveniently be represented in vector diagrams as if it were an electromotive force of self-induction. The quantitative calculation of this electromotive force will be considered in Art. 97. Although only brief mention has been made of the leakage flux in slots other than those in the neutral zone, it is not suggested that this flux is negligible in amount; but the flux distribution under the pole face, whatever may be its distortion, affects only the wave shape (and form factor) of the generated electromotive force, and in no way alters the average value of the developed voltage. The difference between the total flux entering the armature teeth from each pole face and the amount of the slot flux (or the equivalent slot flux) in the neutral zone represents the flux actually cut by all the conductors on the armature.

**96. Calculation of Slot Leakage Flux.**—The effect of slot inductance being generally to reduce<sup>1</sup> the amount of the total air-

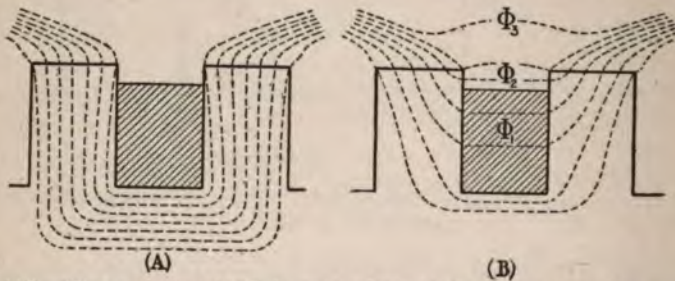

FIG. 112.—Flux entering teeth in neutral zone; showing effect of armature current in producing slot leakage.

gap flux which is actually cut by the conductors, the simplest way to obtain a quantitative value for the slot reactance is to calculate the total flux which leaks from tooth to tooth in the neutral zone. Diagrams (A) and (B) in Fig. 112 indicate the approximate paths of the magnetic lines in the neutral zone, (A) when the current in the slot conductors is zero, and (B) when it has an appreciable value. The amount of flux diverted from the armature core into the leakage paths referred to may be

<sup>1</sup> Except in the case of a condenser load and leading current, in which case the tendency would be to increase the total useful flux.



calculated by assuming the current in the slot conductors to be acting independently of the field magnetomotive force. Thus, in Fig. 113 the total slot flux is the sum of three component fluxes:  $\Phi_1$  passing through the space occupied by the copper, a portion of which will be cut by some of the conductors;  $\Phi_2$  crossing the space above the windings, usually occupied by the wedge; and  $\Phi_3$  which leaks from tooth top to tooth top. If the conductors were concentrated as a thin layer at the bottom of the slot, the loss of voltage due to reduction of core flux (see Fig. 112) could be calculated by assuming that the useful flux is reduced by an amount equal to the slot flux. The portion  $\Phi_1$ , however, in Fig. 113, being cut by some of the conductors, requires the calculations to be based on an equivalent slot flux which, if cut by all the conductors, would develop an electromotive force equal to the actual loss of pressure. This flux may be calculated as follows:

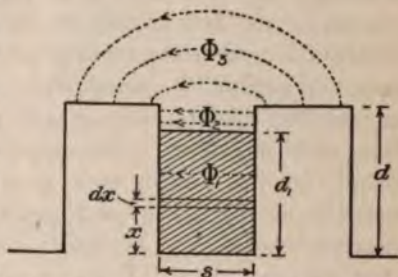

FIG. 113.—Illustrating method of calculating slot leakage flux.

The amount of flux in the small strip  $dx$  deep (Fig. 113) of 1 cm. axial length, *i.e.*, perpendicularly to the plane of the paper, is  $d\Phi_1 = \text{m.m.f.} \times dP$ , where  $dP$  is the permeance of the air path—the reluctance of any iron in the path of the lines being neglected. Whence

$$d\Phi_1 = (0.4\pi T_s I_s) \frac{x}{d_1} \times \frac{dx}{s}$$

where  $T_s$  is the number of conductors per slot;  $I_s$  is the current per conductor in amperes; and the dimensions  $d_1$  and  $s$  (see Fig. 113) are in centimeters. Since, however, this flux element (see Fig. 112, *B*) is cut by  $T_s (d_1 - x)/d_1$  conductors, the loss of pressure is due to the fact that it is *not* cut by  $T_s x/d_1$  conductors. The "equivalent" flux to cause the same loss of pressure would, if it did not link with any of the conductors, therefore be

$$\begin{aligned} d\Phi_1 \text{ (equivalent)} &= d\Phi_1 \times \frac{x}{d_1} \\ \Phi_1 \text{ (equivalent)} &= \frac{0.4\pi T_s I_s}{d_1^2 s} \int_0^{d_1} x^2 dx \\ &= \frac{0.4\pi d_1}{3s} T_s I_s \end{aligned}$$

Thus

The permeances of the air paths of the component fluxes  $\Phi_2$  and  $\Phi_3$  can be calculated fairly accurately (See Art. 5, Chap. II). Let them be  $P_2$  and  $P_3$  respectively. Then, if  $l_a$  is the axial length of the armature core in centimeters, the total "equivalent" slot flux in the neutral zone is

$$\Phi_{es} = 0.4\pi T_s I_s l_a \left( \frac{d_t}{3s} + P_2 + P_3 \right) \quad (104)$$

**97. Effect of Slot Leakage on Full-load Air-gap Flux.**—Before considering a method of drawing the curve of air-gap flux distribution under load, it will be advisable to determine what should be the area of this curve. The area of the required flux distribution curve is a measure of the total flux per pole in the air gap, and it would be possible to express this in terms of the open-circuit flux distribution curve if we knew the e.m.f. that would have to be developed in the armature windings on the assumption of all the flux passing from pole face to armature teeth being actually cut by all the conductors. It is therefore proposed to determine what may be called the "apparent" developed e.m.f., that is to say, the e.m.f. that would be developed in the armature windings under load conditions if it were not for the fact that some of the flux in the air gap leaks across from tooth to tooth in the neutral zone, and is not actually cut by the conductors.

Consider first the condition of zero power factor. The current then lags 90 degrees behind the e.m.f., and reaches its maximum value in the conductors situated midway between poles. The slot leakage flux, and the demagnetizing effect of the armature winding, will then both have reached their maximum value.

In the vector diagram, Fig. 114, let  $OE_t$  represent the required terminal voltage if the machine is mesh-connected, or the corresponding potential difference per phase winding if the machine is star-connected. (In a three-phase Y-connected generator  $OE_t$  would be  $\frac{1}{\sqrt{3}}$  times the terminal voltage.) The vector  $OI$ , drawn 90 degrees behind  $OE_t$ , is the armature current on zero power factor. The impedance-drop triangle is constructed by drawing  $E_t P$  parallel to  $OI$  of such a length as to represent the  $IR$  drop per phase, and  $PE_o$  at right angles to  $OI$  to represent the reactive pressure drop per phase in the end connections.  $OE_o$  is therefore the voltage actually developed in the slot conductors, because it contains the component  $PE_o$  to balance the voltage generated by



the cutting of the end flux, and the component  $E_t P$  to overcome the ohmic resistance of the windings. Now produce  $P E_t$  to  $E'_t$  so that  $E_t E'_t$  represents the voltage that would be developed by the slot flux if this were cut by the conductors.  $O E'_t$ , which may be called the apparent developed voltage, is then the electromotive force that would have been developed in the armature windings if the slot flux had actually entered the core instead of being diverted from tooth to tooth by the action of the current in the conductors. It is therefore also a measure of the total flux passing through the air gap into the armature teeth, and the magnetizing ampere-turns necessary to produce this flux would, on open circuit, actually develop this electromotive force in the armature. Thus when the resultant magnetomotive force in the magnetic circuit is such that  $E'_t$  volts would be developed on open circuit, the terminal voltage under the assumed load con-

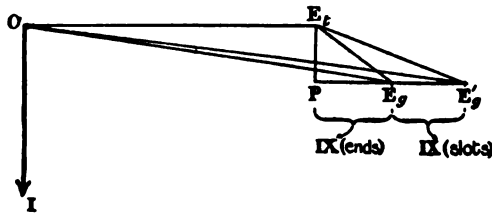

FIG. 114.—Vector diagram of alternator operating at zero power factor.

ditions would be  $E_t$ . It is usual, when the power factor is zero, to consider this loss of pressure as equal to the total reactive drop ( $E'_t P$ ) because, owing to the relative smallness of  $P E_t$  and the fact that its direction is such as to have little effect on the pressure drop, the error introduced by this assumption is negligible.

The length of the vector  $E_t E'_t$  in Fig. 114 can be calculated from the known slot flux  $\Phi_{s..}$  as given by formula (104) of the preceding article. If  $\Phi_a$  is the flux per pole actually cut by the conductors, the total flux per pole in the air gap under load conditions will be  $\Phi = \Phi_a + 2\Phi_{s..}$ .

This total flux, if actually cut by the armature conductors, would generate the electromotive force referred to as the "apparent" developed voltage, and represented by  $O E'_t$  in Fig. 114.

The flux  $2\Phi_{s..}$  maxwells is the portion of the total air-gap flux which, under load conditions, is no longer cut by the armature

conductors. The average value of the voltage lost per phase winding is therefore

$$E_{(average)} = \frac{2\Phi_{es} pN}{10^8 \times 60} (T_s n_s p)$$

or, since  $Np = 120f$

$$E_{(average)} = 4\Phi_{es} f (T_s n_s p) 10^{-8}$$

Assuming the sinusoidal wave shape, it is necessary to multiply by  $\frac{\pi}{2\sqrt{2}}$  to obtain the r.m.s. value. Thus

$$E_s = \frac{2\pi f \Phi_{es} T_s n_s p}{\sqrt{2} \times 10^{-8}} \quad (105)$$

The slot flux in the neutral zone will be a maximum on zero power factor when the current  $I_s$  producing it is approximately equal to the maximum value of the armature current, or to  $\sqrt{2}I_c$ . Inserting this value of  $I_s$  in formula (104) and substituting in formula (105) we get

$$E_s = 2\pi f \times 0.4\pi T_s^2 n_s p l_a I_c \left( \frac{d_1}{3s} + P_2 + P_3 \right) \times 10^{-8} \quad (106)$$

This quantity is usually referred to as the reactive voltage drop per phase due to the slot inductance. It appears as the vector  $E'_s E_s$  in Fig. 114.

If it were permissible to assume the alternating quantities and the flux distribution in the air gap to be sinusoidal, the construction of Fig. 114 might be repeated for conditions other than zero power factor. These assumptions involve the idea of a slot leakage flux diminishing with increasing power factor, the actual change with varying angle of lag being in accordance with the sine law. This does not take into account tooth saturation and distortion of the current wave; but as a practical and approximate method it is permissible. The vector diagram for any power-factor angle  $\theta$  is then as shown in Fig. 115. Here  $\psi$  is the angle of lag between the current and the e.m.f. actually developed in the armature conductors; and  $\cos \psi$  is the "internal" power factor. The angle  $\psi'$  shows the lag of the current behind the "apparent" developed voltage,  $OE'_s$ , and it will be seen that the combined effect of end flux and slot flux is to reduce this voltage by an amount approximately equal to  $PE'_s \sin \psi'$ .

#### 98. Method of Determining Position of Armature M.m.f.—

Turning again to Fig. 108 (page 277), we are still unable to determine the angle  $\beta$ , or the displacement ( $\beta + 90^\circ$ ) of the

maximum armature m.m.f. beyond the center line of the pole, because the angle  $\psi'$  of Fig. 115 shows merely the lag of the current behind the apparent developed e.m.f.; but, owing to armature distortion, the full-load flux distribution curve (from which the voltage  $OE'_g$  is derived) will not be symmetrically placed relatively to the center line of the pole; it will be displaced in the direction of motion of the conductors, *i.e.*, to the right in Fig. 108. With the aid of the vector diagram Fig. 115 we can, however, obtain a value for the angle  $\beta$  of Fig. 108 which will enable us to place the curve of armature m.m.f. in a position relatively to the field m.m.f. which will be approximately correct for any given power factor of the external load. The construction is shown in Fig. 116, and since vectors are used, the assumption of sine-wave functions must still be made. This is where an error is introduced, because the distortion of the flux curves, especially with

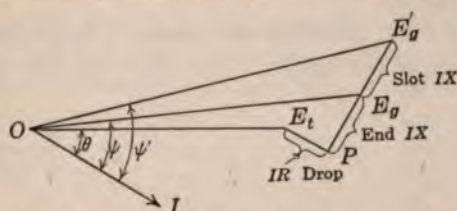

Fig. 115.—Vector diagram of alternator on lagging power factor.

salient-pole machines, is not actually in accordance with this simple law; but the final check on the work will be made later when the flux distribution curves are plotted.

The vectors  $OI$ ,  $OE_t$  and  $OE'_g$  have the same meaning as in Fig. 115, the component  $PE'_g$  being the total reactive voltage drop both of end connections (formula 99) and slot leakage (formula 106). Draw the vector  $OM$  in phase with  $OE'_g$  to represent the resultant m.m.f. necessary to overcome air gap and tooth reluctance when the air-gap flux is such as would develop  $OE'_g$  volts per phase in the armature if it were cut by all the conductors. If we neglect the effect of increased tooth saturation, this m.m.f. can be expressed as

$$OM = (\text{open circuit } SI \text{ per pole}) \times \frac{OE'_g}{OE_t}$$

the open-circuit field excitation being calculated as explained in Arts. 92 and 93. Now draw  $OM_a$  exactly 90 degrees behind  $OI$ , to represent the maximum value of the armature m.m.f. (formula



100). This must be balanced by the field component  $MM_o$ , giving  $OM_o$  as the required field excitation at full load. If the load is now thrown off, the developed voltage will be  $OE_o$ , where the point  $E_o$  is the intersection of  $OM_o$  and the prolongation of the line  $PE'_o$ , because this satisfies the condition  $\frac{OE_o}{OE'_o} = \frac{OM_o}{OM}$ .

The maximum value of the e.m.f.  $OE_o$  will be generated in the conductors immediately opposite the center of the pole face. The required angle of displacement,  $\beta$ , between center line of pole and position of conductor carrying the maximum current may thus be calculated, and the full-load flux curves plotted as in the case of the D.C. machine, where the displacement of the curve of armature m.m.f. is determined by the movement of the brushes. It must not be overlooked that this method is not strictly accurate, since it is based on assumptions that are rarely justified in practice.

**99. Air-gap Flux Distribution under Load.**—Having determined the value of the angle  $\beta$  (Fig. 108), the curve of resultant

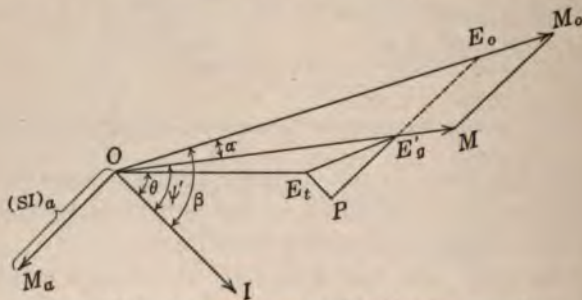

FIG. 116.—Vector diagram of alternator m.m.fs.

m.m.f. for any condition of loading can be obtained by adding the ordinates of the field and armature m.m.f. curves. The procedure is then the same as was followed in the D.C. design to obtain the load flux curve  $C$  (Art. 43, Chap. VII), except that the drawing of the flux curve  $B$  as an intermediate step will not now be necessary, seeing that the effect of armature distortion and demagnetization has been taken account of in the vector construction of Fig. 116. The final check is obtained by measuring the area of flux curve  $C$ , which must satisfy the condition

$$\frac{\text{Area of full-load flux curve } C}{\text{Area of open-circuit flux curve } A} = \frac{OE'_o}{OE_t}$$



If the approximate value of the field ampere-turns, as given by the vector  $OM_o$  of Fig. 116, does not produce the proper amount of flux in the air gap, a correction must be made, and a new curve of resultant m.m.f. obtained, from which the correct full-load flux curve is plotted.

**100. Form of Developed E.m.f. Wave.**—Having plotted the curve of air-gap flux distribution for any given condition of loading, it is an easy matter to obtain a curve of e.m.f. due to the cutting of the flux by the armature conductors. It may be argued that it is not quite correct to derive the e.m.f. wave from the curve of air-gap flux distribution, because the flux actually cut by each armature conductor at a given instant depends not only upon the value of the air-gap density, but also on the amount of the slot leakage flux which is not cut by the conductor. By referring to Fig. 111 (page 283) it will be seen that, although the slot leakage appears at first sight to pass between the pole and the conductor, it actually enters the armature core through the teeth, and, with the exception of the slot flux in the neutral zone, it all links with the armature winding. The shape of the e.m.f. wave is therefore not modified to any great extent by the slot leakage flux; but, unless the armature current is zero in the conductors passing through the neutral zone, the average value of the developed voltage must be less than it would be if all the flux entering the tops of the teeth were cut by the conductors. This is shown in the diagram, Fig. 115, where  $OE'_o$  is the "apparent" developed voltage (assuming all the flux lines in the air gap to be cut), and  $OE_o$  is the actual developed voltage. It is unnecessary to introduce refinements with a view to determining the exact wave shape of the e.m.f. actually developed in the conductors because, by using the flux curve  $C$  of air-gap distribution, the wave shape of the "apparent" developed e.m.f. is obtained, and with the aid of equivalent sine-waves (to be explained later) the terminal voltage can be calculated with sufficient accuracy for practical purposes. It is important to bear in mind that the e.m.f. wave-shape obtained at the terminals of a Y-connected three-phase generator is not necessarily the same as the wave shape developed in each phase-winding by the cutting of the flux in the air gap. This was explained in Art. 71 (page 246), and in order to obtain the wave-form of e.m.f. at the terminals of a Y-connected generator, it is necessary to add the corresponding ordinates of two star-voltage waves plotted with a

phase displacement of one-third of a pole pitch (*i.e.* 60 electrical degrees).

Whatever may be the number and spacing of the slots on the armature surface, the usual e.m.f. wave shapes can always be plotted in the manner indicated in Fig. 117 where the full line curve may be any one of the flux curves previously obtained, the ordinates of which are a measure of the flux density in the air space near the surface of the armature. Draw *A* and *B* properly spaced to represent the slots, *e.g.*, two in this illustration, of one phase of the armature winding. At the instant when the center line *C* of this phase winding occupies the position shown in Fig. 117, the conductors in slot *A* are moving in a field of density *AA'*, while the conductors in slot *B* are moving

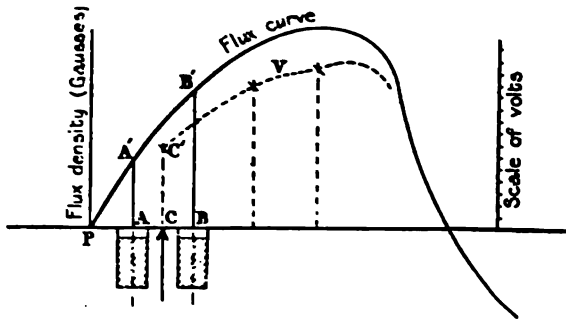

FIG. 117.—Method of deriving e.m.f. wave from curve of air-gap flux distribution.

in a field of density *BB'*. These conductors are all in series, and the instantaneous value of the voltage per phase winding will be

$$e = \frac{B_a N \pi D l_a Z}{60 \times 10^3} \tag{107}$$

where  $B_a$  = average value of flux density, in gauss;   
 $= \frac{AA' + BB'}{2}$  in this instance.

$N$  = revolutions per minute.

$D$  = armature diameter in centimeters.

$l_a$  = armature length (axial) in centimeters.

$Z$  = total number of conductors in series per phase.

This value of  $e$  is plotted as  $CC'$  to a suitable scale, and the process is repeated for other positions of the armature slots, thus producing the dotted curve  $V$ , representing the electromotive force

that would be developed in the windings if all the flux in the air gap were cut by the conductors in the slots.

The general solution, which includes fractional pitch windings, is illustrated in Fig. 118. The instantaneous value of the average flux density for  $n$  slots per pole per phase is

$$B_a = \frac{(a + b + c + \dots) - (a' + b' + c' + \dots)}{2n}$$

The relative positions of the slots and the center of the coil ( $P$ ) may be marked on a separate strip of paper that can be moved to any desired position under the flux curve; and the instan-

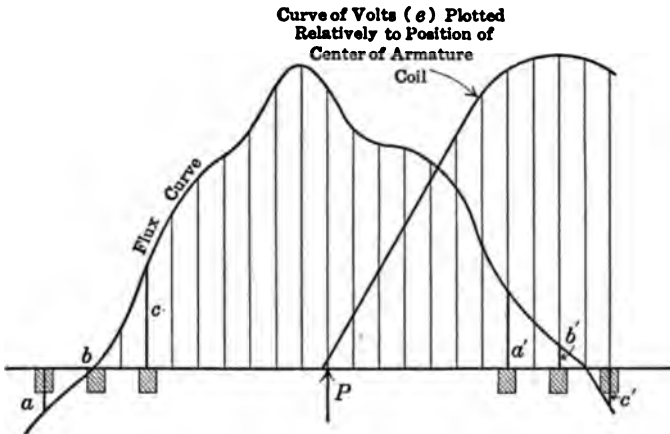

FIG. 118.—Flux curve and resulting e.m.f. wave—fractional pitch armature winding.

taneous values of the voltage can then conveniently be plotted over the point  $P$ . For this instantaneous voltage we may write

$$\left. \begin{aligned} \text{Average instantaneous} \\ \text{e.m.f. per conductor} \end{aligned} \right\} = e_c = \frac{d\Phi}{dt} \times 10^{-8}$$

$$= \text{flux cut per centimeter of travel} \\ \times \text{centimeters per second} \times 10^{-8}$$

$$= (B_a l_a) \times v \times 10^{-8}$$

where  $v = \frac{\pi DN}{60}$  cm. per second. The instantaneous voltage per phase is therefore

$$e = e_c \times z = \frac{B_a N \pi D l_a Z}{60 \times 10^8}$$

as stated in formula (107).

This step-by-step method of drawing the e.m.f. waves will yield surprisingly accurate results, with the one exception that the ripples known as "tooth harmonics" which are generally present in oscillograph records, will not appear in the graphical work. The effect of the distributed winding in smoothing out the irregularities of the flux-distribution curve is very clearly shown by the shape of the e.m.f. wave in Fig. 118.

101. **Form Factor.**—The ratio of the r.m.s. or virtual value to the mean value of an alternating e.m.f. or current is the *form factor*. The average ordinate of an irregular wave such as may be obtained by the process represented in Figs. 117 and 118, is readily obtained by measuring its area with a planimeter and

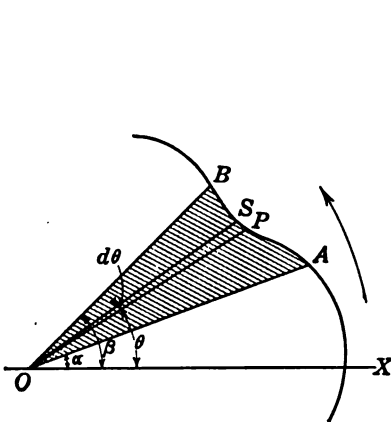

FIG. 119.—Illustrating calculation of r.m.s. value of variable quantity plotted to polar coördinates.

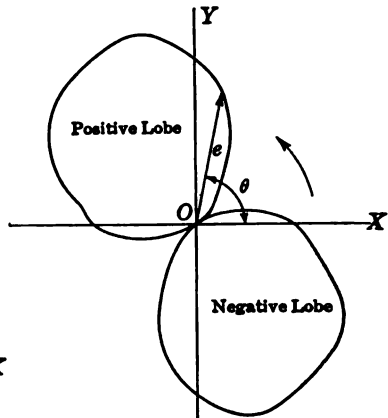

FIG. 120.—Wave of alternating e.m.f. plotted to polar coördinates.

then dividing this area by the length of the base line, *i.e.*, the pole pitch. If another curve is plotted by squaring the ordinates of the original curve, it is merely necessary to take the square root of the average ordinate of this new curve in order to obtain the virtual value of the alternating quantity. It will, however, be more convenient to re-plot the original curve to polar coördinates. The general case of a variable quantity plotted to polar coördinates is illustrated in Fig. 119, where the radial distance from the point *O* represents the instantaneous value of the variable quantity, while time (or distance of travel) is measured by the angular distance between the vector considered and the axis *OX*.



If  $r$  be the length of the vector, and  $\theta$  the angular distance from the reference axis, we may write

$$\begin{aligned}\text{Area of triangle } OSP &= \frac{1}{2}r \times rd\theta \\ &= \frac{1}{2}r^2d\theta\end{aligned}$$

and the area included between any given angular limits  $\beta$  and  $\alpha$  is

$$\begin{aligned}\text{Area } OAB \text{ (shaded)} &= \sum_{\alpha}^{\beta} \frac{1}{2}r^2d\theta \\ &= \frac{1}{2}(\text{average value of } r^2) \times (\beta - \alpha)\end{aligned}$$

whence *average value of*  $r^2 = \frac{\text{twice area of curve}}{\beta - \alpha}$

Applying this rule to the case of a periodically varying e.m.f. or current, we have in Fig. 120 a representation of an e.m.f. wave plotted to polar coördinates. This may be thought of as the actual e.m.f. wave obtained by the graphical method previously outlined, but transferred from rectangular to polar coördinates. The radius vector (moving in a counter-clockwise direction, covers the complete area of one lobe when it has moved through an angle of 180 degrees; because, in this diagram, the electrical degrees are correctly represented by the actual space degrees. The angle moved through during the half period is  $\pi$  radians, and the virtual value of the alternating e.m.f. is therefore

$$E = \sqrt{\frac{2(\text{area of one lobe})}{\pi}}$$

The area of the curve is easily measured with a planimeter, and the value of  $E$  thus obtained has merely to be divided by the previously calculated *average* value in order to obtain the form factor of the irregular wave.

**102. Equivalent Sine-waves.**—Equivalent sine-waves are a great convenience in power calculations because they permit the use of vectors, and enable us to express the power factor as the cosine of a definite angle. Whenever vector diagrams are used, the alternating quantities must be sine functions of time; and when applied to practical calculations involving irregular (*i.e.*, non-sine) wave shapes, they must be thought of as representing "equivalent" sine functions. It will, of course be understood that, in many cases, the substitution of a sine curve for the actual wave form is not permissible; the effects, for instance, of the higher harmonics on a condensive load cannot be annulled by

imagining the actual wave to be replaced by a so-called equivalent smooth wave; but the use of equivalent sine-waves for power calculations on practical A.C. circuits, can generally be justified. An equivalent sine-wave may be defined as a sine-wave of the same periodicity and the same virtual value as the irregular wave which it is supposed to replace. An equivalent sine-wave of current would produce the same heating effects as the irregular wave; but its mean value, and therefore its form factor, may be different.

A sine-wave plotted to polar coördinates will be a circle, of which the diameter—representing the maximum value of the sine-wave—is easily calculated since the equivalent wave must

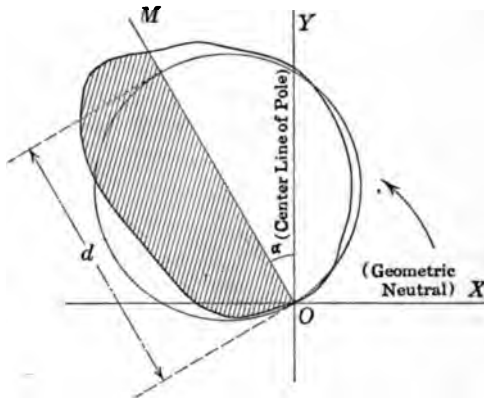

FIG. 121.—Irregular wave and equivalent sine wave plotted to polar coördinates.

have the same root-mean-square value as the non-sinusoidal wave, and therefore also the same area when plotted to polar coördinates.

Let  $d$  = the diameter of the equivalent circle (or maximum value of the equivalent sine-wave)

and let  $A$  = the area of one lobe of the irregular wave plotted to polar coördinates,

then

$$\frac{\pi}{4} d^2 = A$$

whence

$$d = \sqrt{\frac{4A}{\pi}} \tag{108}$$

The next point to consider is the position of the equivalent sine-wave of maximum ordinate  $d$ , relatively to some particular value of the irregular wave. It is obvious that neither the maximum nor the zero value of the two waves must necessarily coincide; but by so placing the equivalent sine-wave relatively to the irregular wave that each quarter wave of the one has the same virtual value as the corresponding quarter wave of the other, the proper position of the equivalent wave may be determined. This will be better understood by referring to Fig. 121.

The irregular wave is plotted to polar coördinates, and its area measured with the aid of a planimeter. The line  $OM$  is then drawn, dividing this area in two equal parts. This is easily done with the help of the planimeter, the proper position of the dividing line being found when the shaded area of the irregular

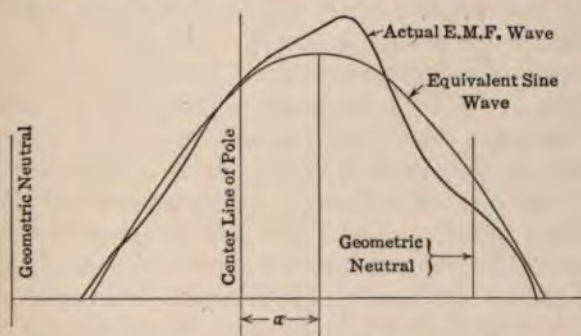

FIG. 122.—Curves of Fig. 121 re-plotted to rectangular coördinates.

wave is exactly equal to the unshaded area. It is upon this line ( $OM$ ) that the center of the equivalent circle of diameter  $d$  (see formula 108) must be placed. If the irregular wave has been correctly plotted relatively to some reference axis, such as the geometrical neutral line, or the pole center, the angle  $\alpha$  can be measured. This angle represents the displacement of the maximum value of the equivalent wave beyond the pole center, and when used in connection with the irregular wave, it may be thought of as the average displacement of the distorted e.m.f. behind the position of open-circuit e.m.f., which will be symmetrically placed about the center line of the pole. This angle  $\alpha$  has the same meaning as the angle  $M_0OM$  of Fig. 116; but it has now been determined with greater accuracy than could be

expected of the vector construction, in which the loss of pressure due to armature distortion was assumed to be in accordance with the sine law. Fig. 122 illustrates the same condition as Fig. 121 except that the e.m.f. waves have been re-plotted to rectangular coördinates. The practical application of equivalent sine-waves in predetermining the regulation of an alternating-current generator will be taken up in the following chapter, and again in Chap. XV, when working out a numerical example.



## CHAPTER XIV

### REGULATION AND EFFICIENCY OF ALTERNATORS

**103. The Magnetic Circuit.**—Except for the fact that the field magnets usually rotate, the design of the complete magnetic circuit of an alternating-current generator differs little from that of a D.C. dynamo. Given the ampere-turns required per pole, and the voltage of the continuous-current circuit from which the exciting current is obtained (usually about 125 volts), the procedure for calculating the size of wire required is the same as would be followed in designing any other shunt coils (see Art. 10, Chap. II and Art. 58, Chap IX). When estimating the voltage per pole across the field winding, a suitable allowance must be made for the pressure absorbed by the rheostat in series with the field windings. The exact amount of excitation required under any given condition of loading can, of course, be determined only after the complete magnetic circuit has been designed.

A higher current density may be allowed in the copper of rotating field coils than in stationary coils against which air is thrown by the rotation of the armature, because the cooling is more effective, the difference being especially noticeable at the higher peripheral speeds. In the absence of reliable data on any particular type and size of machine, the curve of Fig. 123 may be used for selecting a suitable cooling coefficient. The cooling surface considered includes, as before, the inside surface near the pole core and the two ends, in addition to the outside surface of the coil. It is to be understood that the cooling coefficient obtained from Fig. 123 is approximate only, being an average of many tests on different sizes and shapes of coils on rotating field magnets.

In determining the amount by which the pole must project from the yoke ring, it is well to allow about 1 in. of radial length of winding space for every 1,500 ampere-turns per pole required at full load (*i.e.*, estimated maximum excitation). An effort should be made to keep the radial projection of the poles as small as possible in order to prevent excessive magnetic leakage. A

radial length of pole greater than two or two and one-half times the width of pole core (measured circumferentially) would be a poor design, because the gain in winding space due to increase of radial length would be largely neutralized by the greater amount of flux per pole due to leakage.

The required useful flux per pole being known, the flux to be carried by pole core and yoke may be calculated if the leakage factor is known. The calculation of the permeance of the air

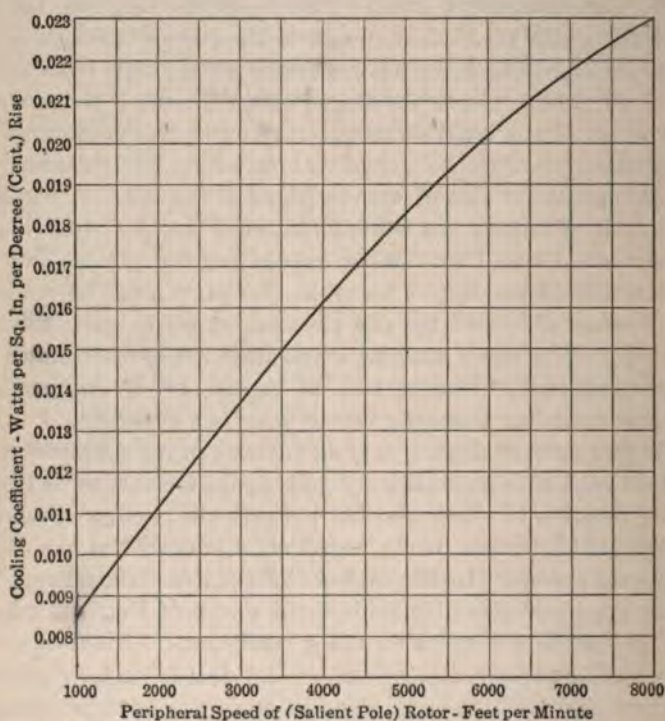

FIG. 123.—Cooling coefficient for field windings of rotating-field alternators.

paths between poles is tedious and somewhat unsatisfactory. It seems therefore best, in designs of normal types, to assume a leakage factor based on measurements made on existing machines. The leakage coefficient will be low in machines with large pole pitch, and high in the case of slow-speed engine-driven generators with a large number of closely spaced poles. The following approximate values may be used for estimating the flux in poles and yoke ring.



High values; to be selected when pole pitch is small, and radial length of pole core great in proportion to width.	}	1.32 to 1.42
Average values; for pole pitch 8 to 12 in., and length of winding space about equal to width of pole core.		1.22 to 1.32
Low values; for large pole pitch and small radial length of pole core.		1.15 to 1.22

These leakage coefficients apply to the case of alternators with field excitation to give approximately normal voltage at terminals on open circuit.

Provided a reasonably high leakage factor has been used, the cross-section of the poles and yoke of good dynamo steel may be calculated for a flux density up to 15,500 gausses. Although the flux density in the pole core (of uniform cross-section) will fall off in value as the distance from the yoke ring increases, the effect of the distributed leakage may be taken care of by calculating the ampere-turns for the pole core on the assumption that the total leakage flux is carried by the pole core, but that the *length* of the pole is reduced to half its actual value.

Bearing in mind the above-mentioned points, the open-circuit saturation curve—connecting ampere-turns per pole and resulting terminal voltage—can be calculated and plotted exactly as in the case of a continuous-current dynamo with rotating armature and stationary poles (see Art. 57, Chap. IX, and item 128 of Art. 63, Chap. X).

**104. Regulation.**—Reference has already been made in Art. 77 of Chap. XI to the regulation of alternating-current generators, and it was pointed out that the designer does not always aim at producing a machine with a high percentage inherent regulation, because it is recognized that automatic field regulation or some equivalent means of varying the field ampere-turns is necessary in order to maintain the proper terminal voltage under varying conditions of load and power factor. The large modern units driven at high speeds by steam turbines are, indeed, purposely designed to have large armature reactance in order to limit the short-circuit current, the maximum value of which—at the instant the short-circuit occurs—depends rather upon the armature reactance than upon the demagnetizing or distortional effect of the armature current. These considerations tend to emphasize the importance of correctly predetermining the inherent regulation of machines, and it is important to know exactly what the term “armature reactance” should include, in order

that the probable short-circuit current may be estimated, not only after the armature ampere-turns have had time to react upon the exciting field, but also at the instant when the impedance of the armature windings alone limits the current.

The usual methods of predetermining the regulation of alternators involve almost invariably the use of vectors or vector algebra. This is convenient, and to some extent helpful, because the problem is thus presented in its simplest aspect: the very fact that vectors are used assumes the sinusoidal variation of the alternating quantities, or the substitution of so-called

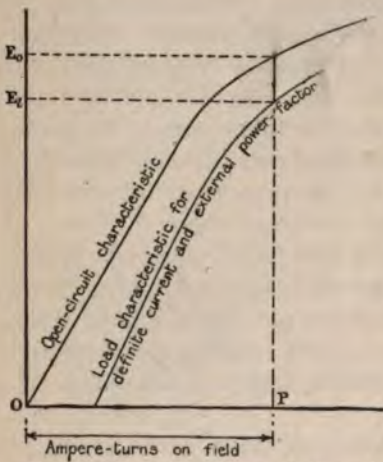

FIG. 124.—Inherent regulation obtained from open-circuit and load saturation curves.

equivalent sine-wave forms for the actual wave shapes, thus eliminating the less easily calculated effects caused by cross-magnetization and the consequent distortion of the wave shapes. On the other hand, the omission of these factors, especially when departures are made from standard types, may lead to incorrect conclusions, and in any case the plotting of the actual flux and e.m.f. curves is of great value to the designer.

It is therefore proposed to consider in the first place what is the best that can be done with the aid of vectors on the usual assumption of sine-wave form, and afterward show how a greater degree of accuracy can be attained by using curves representing the actual flux distribution in the air gap, corresponding to the required load conditions.

The curves in Fig. 124 may be considered as having been plotted from actual test data. The upper curve is the open-circuit saturation characteristic, giving the relation between the number of ampere-turns of field excitation per pole and the pressure at the terminals, which in this case is the same as the electromotive force actually developed in the armature windings. The lower curve is the load characteristic corresponding to a given armature current and a given external power factor. The inherent regulation when the field excitation is of the constant



value  $OP$  is therefore the difference of terminal voltage  $E_oE_i$  divided by the load voltage  $E_i$ , or, expressed as a percentage of the lower voltage,

$$\frac{OE_o - OE_i}{OE_i} \times 100$$

Thus the error in predetermining the inherent regulation depends upon the degree of accuracy within which curves such as those shown in Fig. 124 can be drawn before the machine has been built and tested.

**105. Factors Influencing the Inherent Regulation of Alternators.**—By enumerating all the factors which influence the terminal voltage of a generator driven at constant speed with constant field excitation, it will be possible to judge how nearly the methods about to be considered approximate to the ideal solution of the problem. These factors are:

(a) The total or resultant flux actually cut by the armature windings (this involves the flux linkages producing armature reactance).

(b) The ohmic resistance of the armature windings.

(c) The alteration in wave shape of the generated electromotive force, due to changes in air-gap flux distribution. This means that the measured terminal voltage depends not only upon the amount of flux cut by the conductors but also upon the distribution of flux over the pole pitch, because the amount of flux cut determines the average value of the developed voltage, while the form of the e.m.f. wave determines the relation between the mean value and the virtual or r.m.s. value.

By far the most important items are included under (a), and it will be well to consider exactly how the resultant flux cut by the armature windings varies when load is put on the machine.

Considering first the flux cut by the active belt of conductors under the pole face, this is not usually the same under load conditions as on open circuit (the field excitation remaining constant), for the following reasons. The current in the armature windings produces a magnetizing effect which, together with the field-pole magnetomotive force, determines the resultant magnetomotive force and the actual distribution of the flux in the air gap. When the power factor of the load is approximately unity, the armature current produces cross-magnetization and distortion of the resultant field, accompanied usually by a reduction of the total flux owing to increased flux density in the

armature teeth where the air-gap density is greatest. The effect is, however, less marked in alternating-current than in continuous-current generators, because in the former the tooth density is rarely so high as to approach saturation. On low power factor, with lagging current, the armature magnetomotive force tends to oppose the field magnetomotive force, and on zero power factor its effect is wholly demagnetizing, thus greatly reducing the resultant air-gap flux. With a leading current the well-known effect of an increased flux and a higher voltage is obtained. The effect known as armature reaction, as distinguished from armature reactance, is therefore dependent not only on the amount of the armature current but also largely upon the power factor.

The effect of the individual conductors in producing slot leakage was discussed in Art. 95 of Chap. XIII, and illustrated by Figs. 110 and 111, wherein it is clearly shown that, as current is taken out of the armature, the total flux cut by the active conductors is less than at no load (with the same field excitation) by the amount of the slot flux—or equivalent slot flux—which passes from tooth to tooth in the neutral zone.

Turning now to the flux cut by the end connections, *i.e.*, by those portions of the armature winding which project beyond the ends of the slots, this flux is set up almost entirely by the magnetomotive force of the armature windings, and is negligible on open circuit. For a given output and power factor, the end flux in a polyphase generator is fixed in position relatively to the field poles, being stationary in space if the armature revolves. The maximum value of the armature magnetomotive force occurs at the point where the current in the conductors is zero, and on the assumption of a sinusoidal flux distribution, the electromotive force generated by the cutting of these end fluxes may be represented correctly as a vector drawn 90 degrees behind the current vector. It is therefore permissible to consider this e.m.f. component as a reactive voltage such as would be obtained by connecting a choking coil in series with the "active" portion of the armature windings; and if the inductance,  $L_c$ , of the end windings is known, and a sinusoidal flux distribution assumed, the electromotive force developed by the cutting of the end fluxes under load conditions is given by the well-known expression  $2\pi f L_c I_c$ , where  $I_c$  is the virtual value of the current in the armature windings, and  $f$  is the frequency.



This quantity was calculated in Art. 87, Chap. XII, and expressed in formula (99), the calculation being based upon an amount of end flux per pole ( $\Phi_e$ ) given by the empirical formula (98). Although the writer likes to think of the cutting of the end flux by the conductors projecting beyond the ends of the slots, the idea of flux-linkages and a coefficient of self-induction,  $L_e$ , expressed in henrys, may be preferred by others. If it is desired to substitute the terms of the formulas (98) and (99) in the expression  $2\pi f L_e I_c$ , the value of the coefficient of self-induction, in henrys, will be

$$L_e = \frac{\Phi_e \left( \frac{p T_s n_s}{2} \right)}{I_{max} \times 10^8}$$

**106. Regulation on Zero Power Factor.**—In practice, any power factor below 20 per cent. is usually considered to be equivalent to zero, so that the calculations can be checked when the machine is built, by providing as a load for the generator a suitable number of induction motors running light. On these low power factors with lagging current the phase displacement of the armature current causes the armature magnetomotive force to be almost wholly demagnetizing, that is to say, it directly opposes the magnetomotive force due to the field windings, the distortional or cross-magnetizing effect being negligible. Its maximum value per pole is given by formulas (100) and (101) of Art. 94, Chap. XIII, and its effect in reducing the flux in the air gap is readily compensated (on zero power factor) by increasing the field excitation so that the resultant ampere-turns remain unchanged. This statement is not strictly correct because the increased ampere-turns on the field poles give rise to a greater leakage flux, and this alteration should not be overlooked, especially when working with high flux densities in the iron of the magnetic circuit. If the estimated leakage flux for a given developed voltage on open circuit is  $\Phi_l$  maxwells, then, for the same voltage with full-load current on zero power factor, the leakage flux would be approximately  $\Phi'_l = \Phi_l \left( \frac{M + M_a}{M} \right)$  where  $M$  is the number of field ampere-turns on open circuit, and  $(M + M_a)$  is the number of field ampere-turns with full-load current in the armature, the power factor being zero. The quantity  $M_a$  is the demagnetizing ampere-turns per pole due to the armature current.

Let curve *A* of Fig. 125 be the open-circuit saturation curve

of the machine, referred to in Art. 103; it is the curve for the complete machine, and can be plotted only after the magnetic circuit external to the armature has been designed.

Knowing the increase of flux in pole and frame the magnetomotive force absorbed in overcoming the increased reluctance of these parts can be calculated, and in this way the dotted curve  $A'$  of Fig. 125 can be drawn. This is merely the open-circuit saturation curve corrected for increased leakage flux due to the additional field current required to balance the demagnetizing effect of a given armature current.

Assuming all the alternating quantities to be simple harmonic functions, the vector diagram

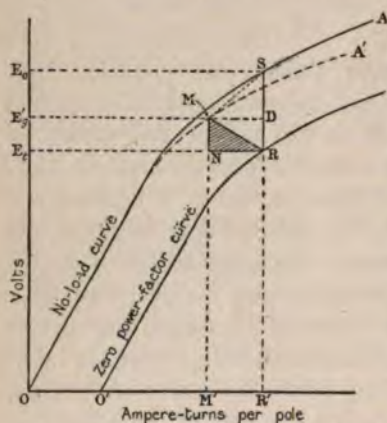

FIG. 125.—Methods of constructing saturation curve for zero power factor.

(Fig. 126) can be drawn as explained in Art. 96. It shows the voltage components for one phase of the winding; the vector  $PE_t$  being the  $IR$  drop, while  $E_gP$  and  $E'_gE_g$  stand for the reactance voltage drops due to end flux and slot flux respectively. The numerical value of  $E_gP$  can be obtained from formula (99) page 266, and of  $E'_gE_g$  from formula (106) of page 288.

The apparent developed voltage  $E'_g$  obtained from Fig. 126 gives the point  $M$  on the corrected no-load saturation curve  $A'$  in Fig. 125, and the distance  $E'_gM$  or  $OM'$  shows what exciting ampere-turns are required to develop this electromotive force. The terminal voltage is, however, only  $E_t$ , which gives the point  $N$  of the triangle  $MNR$ . Now draw  $NR$  parallel to the horizontal axis to represent the total number of ampere-turns per pole due to the armature current, which, as previously explained, will be entirely demagnetizing, and must therefore be compensated by an equal number of ampere-turns on the field pole. Thus  $E_tR$  or  $OR'$  is the field excitation necessary to produce  $E_t$  volts at the terminals of the machine. If the load is now thrown off, the terminal pressure will rise to  $E_0$  and the percentage regulation for this particular current output on zero power factor will therefore be  $100 \frac{SR}{RR'}$ . This simple construction enables the de-



signer to predetermine with but little error the regulation on zero power factor provided he can correctly calculate the reactances required for the vector quantities of Fig. 126. The complete load characteristic  $O'R$  is quickly obtained by sliding the triangle  $MNR$  along the corrected no-load saturation curve.<sup>1</sup> The difference of pressure,  $SR$ , corresponding to any particular value  $OR'$  of field excitation (Fig. 125) is called the *synchronous reactance drop* because, although it is made up partly of real reactance drop and partly of armature reaction, it may conveniently be treated as if it were due to an equivalent or fictitious reactance capable of producing the same total loss of pressure if the magnetomotive force of the armature had no demagnetizing or distortional effect. Thus, by producing the line  $PE'_g$  to  $E_o$  in Fig. 126, so that  $PE_o$  is equal to  $RS$  of Fig. 125, the vector diagram shows the difference between the open-circuit pressure  $OE_o$  and the terminal

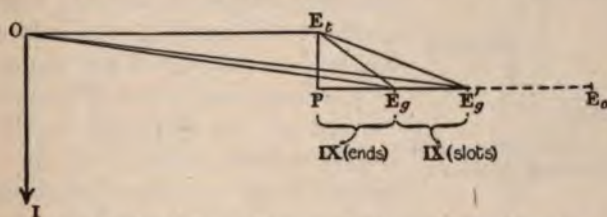

FIG. 126.—Vector diagram for zero power factor.

pressure  $OE_t$  under load conditions at zero power factor when the field excitation is maintained constant. The additional (fictitious) reactance drop  $E_oE'_g$  is correctly drawn at right angles to the current vector because on zero power factor the effect of the armature magnetomotive force is wholly demagnetizing; in other words, it tends to set up a magnetic field displaced exactly 90 degrees (electrical space) behind the current producing it; hence when the load is thrown off, the balancing m.m.f. component on the field poles will generate the additional voltage in the phase  $OE_o$ . It should be realized that the fictitious reactance drop,  $E_oE'_g$  of Fig. 126, cannot be predetermined until the whole of the

<sup>1</sup> S. H. MORTENSEN. "Regulation of Definite Pole Alternators." *Trans. A. I. E. E.*, vol. 32, p. 789, 1913. Also B. A. BEHREND. "The Experimental Basis for the Theory of the Regulation of Alternators." *Trans. A. I. E. E.*, vol. 21, p. 497, 1903; and B. T. McCORMICK in discussion on "A Contribution to the Theory of the Regulation of Alternators" (H. M. HOBART and F. PUNGA). *Ibid.*, vol. 23, p. 330, 1904.

magnetic circuit of the machine has been designed. The distance  $DR$  in Fig. 125 is the loss of voltage corresponding to  $E'P$  of Fig. 126, and is approximately constant for a given armature current. The portion  $SD$ , however, of the total difference of voltage depends on the slope of the line  $MS$ , and is thus some function of the degree of saturation of the iron in the magnetic circuit. It is far from being constant (except over the linear part of the open-circuit saturation curve) and must be measured off the diagram for each different value of the field excitation. This diagram (Fig. 125) shows very clearly the advantage of high flux

densities (magnetic saturation) in some portion of the magnetic circuit, if good regulation is aimed at.

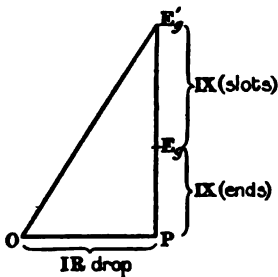

FIG. 127—Vector diagram of short-circuited armature.

**107. Short-circuit Current.**—The amount of the short-circuit current is intimately connected with the regulating qualities of a machine, and in large generators becomes a matter of importance.

The maximum value of the armature current at the instant a short-circuit occurs depends mainly on the inductance of the armature windings; but

when the armature magnetomotive force has had time to react on the field and has actually reduced the flux of induction in the air gap, the resulting current may be fairly accurately calculated by using the construction indicated in Figs. 127 and 128.

The vector triangle Fig. 127 is constructed for any assumed value,  $I_c$ , of the armature current. It shows that when the terminal voltage is zero, the machine being short-circuited, the flux in the air gap must be such that the pressure  $OE'$ , would be developed in the armature conductors on open circuit. The value  $OF$  (Fig. 128) of the ampere-turns necessary to produce this flux in the air gap is thus obtained, the ordinate  $OE'$ , being the generated voltage as determined by the vector diagram. Now since the magnetomotive force of the armature windings will be almost wholly demagnetizing, it is correct to assume that the field excitation must be increased by an amount equal to the maximum armature ampere-turns per pole in order that the resultant excitation may be  $OF$ . Thus  $FG$  in Fig. 128 is made equal to the maximum armature ampere-turns, and by drawing, to a suitable scale, the ordinate  $GJ$  equal to the assumed armature current  $I_c$ ,

the point  $J$  on the short-circuit current curve is obtained. By repeating the construction for any other assumed value of the current it will be seen that so long as  $E'$  lies on the linear portion of the no-load characteristic, the relation between the short-circuit current and the field-pole excitation is also linear. When the field excitation is  $OL$ , giving a pressure  $OE_0$  on open circuit, the short-circuit current will be  $LK$ .

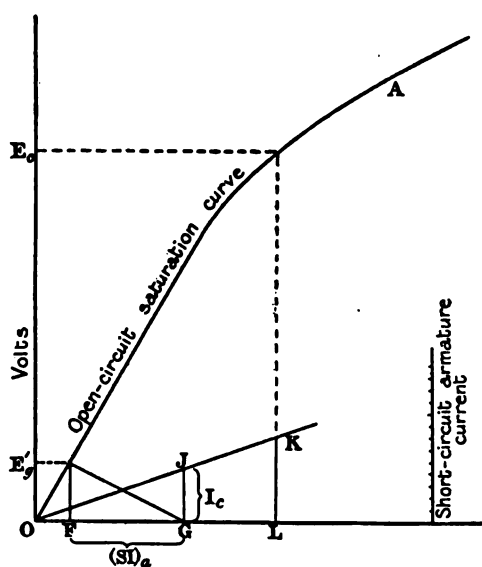

FIG. 128.—Method of constructing curve of armature current on short-circuit.

**108. Regulation on any Power Factor.**—Unless the effects of cross-magnetization are taken into account, it is impossible to predetermine the regulation accurately when the power factor differs appreciably from zero, but by the intelligent use of vector quantities (involving as they do the assumption of simple harmonic curves) very satisfactory results can be obtained. The best method known to the author by which the load saturation curve for any power factor may be drawn, without resorting to flux distribution and wave-shape analysis, is that given by PROFESSOR ALEXANDER GRAY,<sup>1</sup> and recently embodied in the Standardization rules of the American Institute of Electrical Engineers. A. E. CLAYTON<sup>2</sup> has also suggested a similar method.

<sup>1</sup>A. GRAY. "Electrical Machine Design."

<sup>2</sup>*Electrician*, vol. 73, p. 90, 1914.

Let the external power factor be  $\cos \theta$ , and  $OR'$  (Fig. 129) the constant field excitation which would, on open circuit, develop the pressure  $E_o$ , represented by  $R'S$ . The full-load-current zero-power-factor saturation curve  $O'R$  has been drawn as previously described. If then it is possible to determine the point  $Q$  on the full-load saturation curve for power factor  $\cos \theta$ , the required percentage regulation may be expressed as  $100 \frac{QS}{QR'}$ .

In Fig. 130 draw the right-angled triangle  $E_iPE_o$  such that  $PE_i$  represents the armature resistance drop per phase with full-load current, and  $E_oP$  the corresponding synchronous reactance drop, as given by  $SR$  in Fig. 129. From  $E_i$  draw the line  $E_im$

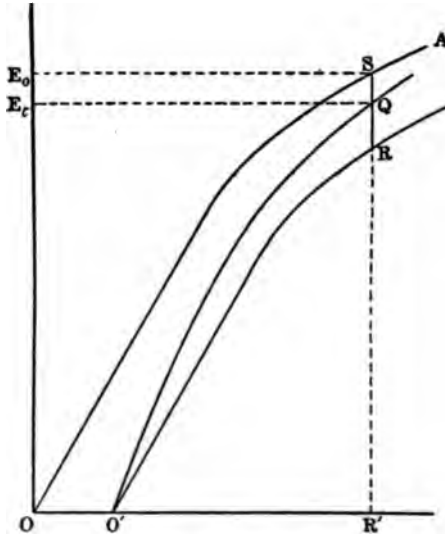

FIG. 129.—Method of constructing saturation curve for any load and power factor.

of indefinite length and so that  $mE_iP$  is the required power-factor angle  $\theta$ . From  $E_o$  as center describe the arc of a circle of radius  $R'S$  (Fig. 129) equal to the open-circuit voltage, and cutting  $mE_i$  produced at  $O$ . Then  $OE_i$  will be the required terminal voltage, which may be plotted as  $R'Q$  in Fig. 129. This construction provides for the proper angle  $\theta$  between terminal voltage and current; and in regard to the relation between the terminal voltage  $E_t$  and the open-circuit voltage  $E_o$  when load is thrown off, it will be seen that the total synchronous reactive drop has



been used in the impedance triangle  $E_tPE_o$  of Fig. 130. This virtually assumes the demagnetizing and distortional effects of the armature current to be equivalent to a fictitious reactance drop capable of being treated vectorially like any other reactance drop, and of which the direct effect on regulation is proportional to the sine of the angle of lag—a not unreasonable assumption, though scientifically inaccurate. This gives good results in machines of normal design. It is when departures are made from standard practice that such approximations are liable to be abused.

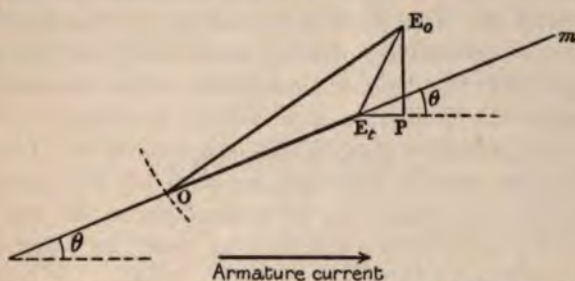

FIG. 130.—Vector diagram showing construction to obtain terminal voltage for any load and power factor.

**109. Influence of Flux Distribution on Regulation.**—So long as a sinusoidal air-gap flux distribution can be assumed both on open circuit and under load conditions, the previously described methods of predetermining regulation are satisfactory; but in the case of new or abnormal designs of machines, correct results can be obtained only by taking into account the alteration in the amount of the useful flux due to cross-magnetization and the changes in the e.m.f. wave-shapes due to flux distortion. An attempt will be made to outline as briefly as possible a method of study which, although it has been elaborated by the writer, is not essentially new; indeed, it is probably used in a modified form by some practical designers when aiming at a closer degree of accuracy than can be expected from methods based on the usual sine-wave assumptions.

The method about to be described is based on the fact that for salient-pole machines approximately correct flux-distribution curves can be drawn when the width and shape of the pole shoe have been decided upon; and for high-speed generators with air gap of constant length, when the disposition and windings of the slots in the rotor have been determined. From these flux curves,

whether representing open-circuit or loaded conditions, the e.m.f. waves and their form factors can be obtained, all as explained in Arts. 100 and 101 of Chap. XIII, and the problem of regulation may be summed up as follows: Plot the open-circuit saturation curve for the complete magnetic circuit, correcting for the form factor of the developed voltage if this departs appreciably from the assumed value of 1.11. Now obtain the actual flux distribution and corresponding full-load "apparent" developed voltage for a given power factor, and correct for the internal pressure losses—ohmic and reactive. Let  $E_t$  be full-load terminal voltage obtained by this method. The field excitation for air gap and teeth is known for the particular condition considered, and the ampere-turns required to overcome the reluctance of the remaining parts of the magnetic circuit are also readily ascertained since the total flux per pole (the area of full-load flux curve  $C$ ) is known. It is therefore merely necessary to read off the open-circuit characteristic the voltage  $E_o$  corresponding to the ascertained value of the total field excitation in order to determine the regulation, which is  $\frac{E_o - E_t}{E_t}$ .

The actual working out of the problem is not quite so simple as this statement may suggest, the chief difficulty being that a knowledge of the external power-factor angle is insufficient to determine the exact position of the armature m.m.f. curve relatively to the center line of the pole. The position of this curve depends upon the internal power-factor angle and also upon the phase displacement of the generated electromotive force under load conditions, *i.e.*, on the degree of distortion of the resultant air-gap flux which, on open circuit, was distributed symmetrically about the center line of the pole face. The manner in which the displacement of the armature m.m.f. curve may be determined approximately, for any given external power factor, was explained in Art. 98 and illustrated by the vector diagram, Fig. 116.

**110. Outline of Procedure in Calculating Regulation from Study of E.m.f. Waves.**—In Fig. 131 let the curve  $F$  represent the distribution of magnetomotive force over the armature surface tending to send flux from pole to armature on open circuit. Let  $BD$  be the magnetomotive force due to armature current only. If the load current be sinusoidal (an almost essential assumption, since its exact shape cannot be predetermined),  $BD$  will also be a sine curve, the maximum ordinate  $CD$  of which will



be displaced beyond the center line of the pole by an amount depending upon the power factor of the load and the distortion of the resulting air-gap flux distribution. This maximum value will occur where the current in the conductors is zero, and the maximum armature current will be carried by the conductor displaced exactly 90 degrees (electrical space) from the point *C*. The point *B* is therefore the position on the armature surface, considered relatively to the poles, where the current is a maximum, the length *AB* or  $\beta$ , which depends largely on the power factor, being determined approximately as explained in Art. 98. Add the ordinates of curves *F* and *D* to get the curve *M* which gives the resultant magnetomotive force under the assumed conditions of load. Having calculated the permeance of the

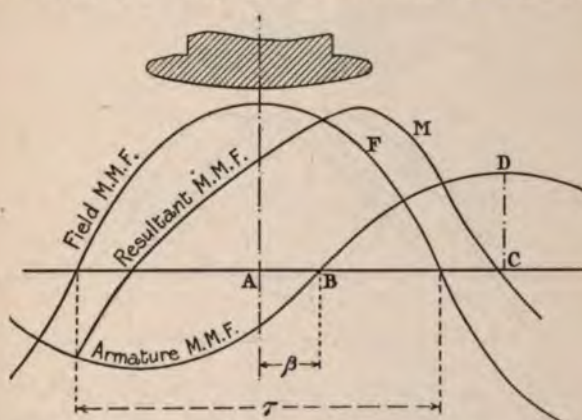

FIG. 131.—Distribution of m.m.f. over armature surface.

magnetic circuit for various points on the armature surface, the flux distribution curves *A*<sub>0</sub> and *C* of Fig. 132 can be plotted. The first, which represents open-circuit conditions, is plotted from the m.m.f. curve *F*, while curve *C*, showing the flux distribution under load, is derived from the m.m.f. curve *M*. The respective areas of these curves are a measure of the total air-gap flux under the two conditions, but we cannot say that the actual ampere-turns on the field will be the same in both cases, because the component of the total m.m.f. required to overcome the reluctance of the pole-core and yoke ring has not been taken into account.

The correct solution of the problem involves the actual wave shapes of the developed electromotive forces. Assuming

all the flux in the air gap to be cut by the armature conductors, the wave shapes of the "apparent" developed e.m.fs. can be drawn, and their form factors calculated as explained in Arts. 100 and 101. The terminal voltage—which must be known before the regulation can be calculated—is most readily obtained by using vector diagrams; but this involves the substitution of "equivalent sine curves" for the irregular waves. The maximum value of a so-called equivalent sine wave is  $\sqrt{2}$  times the r.m.s. value of the irregular wave; but its time phase relatively to any defined instantaneous value of the irregular wave is not so easily determined. It can be obtained from the irregular curve when plotted to polar coördinates as explained in Art. 102, Chap. XIII;

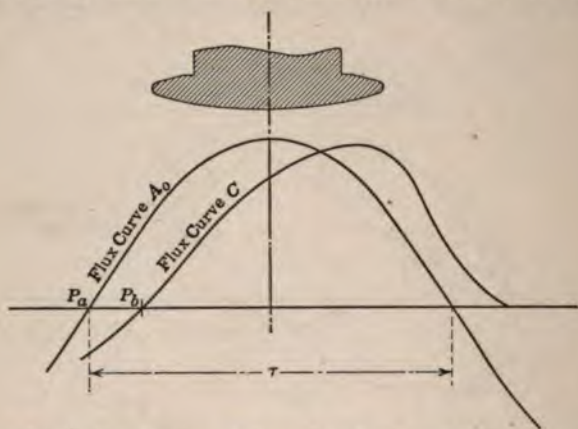

FIG. 132.—Flux distribution, (C) under load, and (A<sub>0</sub>) when load is thrown off.

but a method to be preferred for purposes of explanation, although more tedious, consists in obtaining the average value of the true power and making the displacement between electromotive force and current vectors equal to  $\cos^{-1} \left( \frac{\text{true power}}{\text{apparent power}} \right)$ . The current wave (assumed to be a sine curve) from which the m.m.f. curve *BD* of Fig. 131 is derived would have its maximum value at the point *B*, displaced  $\beta$  electrical degrees beyond the center, *A*, of the pole. The actual full-load e.m.f. wave, can also be drawn in the correct position relatively to the center line of the pole; and, by multiplying the corresponding instantaneous values of electromotive force and current, the power curve can be drawn and the average value of its ordinates calculated. The ratio



of this quantity to the volt-amperes is equal to the cosine of the angle  $\psi'$  in Fig. 133. This vector diagram can be constructed as follows:

Draw  $OE_o$  representing the phase of the open-circuit voltage, *i. e.*, the center of the pole, to be used as a reference line from which the phase angles can be plotted. Make the angle  $E_oOI_c$  equal to  $\beta$  of Fig. 131. This is the estimated lag of current behind the open-circuit electromotive force. Draw  $OE'_g$  equal in length to the calculated e.m.f. value of the "apparent" developed voltage under load conditions, and so that  $\psi' = \cos^{-1} \left( \frac{\text{watts}}{\text{volt-amperes}} \right)$ , where the watts referred to are calculated by multiplying the corresponding instantaneous values of  $E'_g$  and  $I_c$ . From  $E'_g$  drop a perpendicular on to  $OI_c$ , and set off

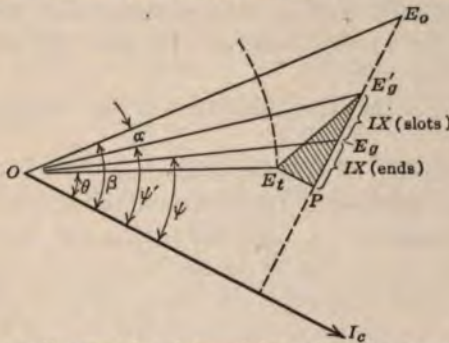

FIG. 133—Vector diagram for determining the inherent regulation of an alternating-current generator.

$E'_g$ ,  $E_g$  and  $E_gP$  to represent the reactance drops per phase in slots and end connections respectively. Draw  $PE_t$  parallel to  $OI_c$  to represent the resistance pressure drop per phase, and join the point  $O$  with  $E_g$  and  $E_t$  respectively. The angle  $E_tOI_c$  and the length of the vector  $OE_t$  may not correspond with the exact values of external power factor and terminal voltage assumed when the angle  $\beta$  was originally estimated; but, by using the vector construction on the assumption of sine-waves throughout, a very close estimate of these quantities can be made. The important point in connection with this method of analysis is that the external power-factor angle  $\theta$  and the terminal voltage  $E_t$  can be calculated for any value of the armature current  $I_c$  when the phase displacement of the latter relatively to the open-circuit voltage is assumed.

The field ampere turns necessary to produce the terminal voltage  $OE_t$  of the vector diagram Fig. 133 are made up of the ampere turns for air gap and armature teeth, represented by the maximum ordinate of the curve  $F$  of Fig. 131, together with the ampere turns required to overcome the reluctance of the pole-core, yoke ring, and armature core. These additional ampere turns are readily calculated because the total useful flux per pole is known, being represented by the area of the curve  $C$  of Fig. 132.

Having determined the total ampere turns per pole which are necessary to give  $OE_t$  volts (of Fig. 133) at the terminals, it is easy to read the corresponding open-circuit voltage from the no-load saturation curve of the machine. In this manner the regulation corresponding to a known external power factor,  $\cos \theta$ , can be calculated with greater accuracy than will usually be obtained by the method outlined in Art. 108, and illustrated by Figs. 129 and 130.

The meaning of the other quantities in Fig. 133 may be summed up as follows:

The angle  $E_oOE'_g$ , or  $\alpha$ , is the phase difference between equivalent sine-waves representing open-circuit voltage and "apparent" developed voltage under load conditions. It is the result of flux distortion due to the armature cross-magnetizing ampere-turns. The vector  $OE_g$  gives the r.m.s. value of the voltage per phase actually developed in the armature winding by the cutting of the flux linking with the "active" conductors.

The angle  $E_oOI_c$ , or  $\psi$  is the internal power-factor angle. The difference in length between  $OE_o$  and  $OE'_g$  is the voltage drop due to armature demagnetization and distortion. The point  $E_o$  is shown in Fig. 133 on  $PE'_g$  produced, but it does not necessarily fall on this straight line, and so indicates one important difference between the construction of Fig. 133 and that of Fig. 130, in which the assumptions made are not universally applicable.

The use of vectors and vector constructions, such as were first described, will usually give sufficiently accurate results without the expenditure of time and labor involved in the plotting of flux curves and e.m.f. waves. It is in the case of abnormal designs, or when the conditions are unusual, that the problem of regulation may be studied most conveniently and correctly by a method such as that here described, which is subject



to modification in matters of detail and may be elaborated if desired.

In the writer's opinion, a further advantage of the method of flux distribution and wave-form analysis lies in the fact that the designer obtains thereby a clearer conception of the factors entering into the problem of regulation than he is ever likely to obtain if he confines himself to the use of formulas and vector diagrams, which are always liable to be abused when familiarity with their purpose and construction leads to forgetfulness of their meaning and limitations.

**111. Efficiency.**—In estimating the efficiency of an alternating-current generator before it is built, the same difficulties occur as in the case of the dynamo. There are always some losses such as windage, bearing friction, and eddy currents, which cannot easily be predetermined, and it is therefore necessary to include approximate values for these in arriving at a figure for the total losses. Very little need be added to what has already been said in Art. 60 of Chap. IX, to which the reader is referred. He should also consult the working out of the numerical example under items (148) and (149) in Art. 63; and make a list of all the losses occurring in the machine at the required output and power factor. In the ratio  $efficiency = \frac{output}{output + losses}$ , it is the actual output of the generator at a given power factor with which we are concerned, and not the rated k.v.a. output.

Windage and bearing friction losses are never easily estimated; but the following figures may be used in the absence of more reliable data.

APPROXIMATE WINDAGE AND FRICTION LOSSES EXPRESSED AS PERCENTAGE OF FULL-LOAD OUTPUT

	K.v.a. output	Windage and bearing friction
Self-ventilated A.-C. generators . . . . .	50	1.5 per cent.
	200	1.0 per cent.
	500 and	
	larger	0.5 per cent.
Turbo-alternators: forced ventilation (exclusive of power to drive fan) . . . . .	2,000	1.8 per cent.
	5,000	1.5 per cent.
	10,000	1.2 per cent.
	15,000	1.0 per cent.
	20,000	0.9 per cent.

The power required to drive the ventilating fan for turbo-alternators will generally be from 0.3 to 0.5 per cent. of the rated full-load output of the generator.

The brush-friction loss is usually small. If  $A$  is the total area of contact, in square inches, between brushes and slip rings, and  $v$  is the peripheral velocity of the slip rings in feet per minute, the brush-friction loss will be approximately  $\frac{vA}{100}$  watts.

The hysteresis and eddy-current losses in the iron can be calculated for any given load because the required developed voltage, and therefore the total flux per pole, are known. The losses in the teeth can now be calculated with greater accuracy than before the full-load flux curves were drawn, because the maximum value of the tooth density will depend upon the maximum value of the air-gap flux density as obtained from the flux distribution curve for the loaded machine, as explained in Art. 60 (page 196). Unless the density in the teeth is high, it is usually unnecessary to calculate the *actual* tooth density because the "apparent" tooth density may be used in estimating tooth losses; but with low frequency machines the density in the teeth may be carried well above the "knee" of the  $B$ - $H$  curve, and it would then be necessary to determine the actual tooth density as explained in Art. 37 of Chap. VII under dynamo design.

*Eddy Currents in Armature Conductors.*—The  $I^2R$  loss in the armature copper may be calculated when the cross-section and length of the winding are known; but in the case of large machines with heavy conductors, the eddy-current loss in the "active" conductors may be considerable, and an allowance should then be made to cover this. The eddy currents in the buried portions of the winding are due to two causes:

1. The flux entering the sides of the teeth through the top of the slot.

2. The slot leakage flux which the armature conductors themselves produce when the machine is delivering current to the circuit.

The loss due to (1) is independent of the load, and would be of importance in the case of solid conductors of large cross-section in wide open slots. With narrow, or partially closed, slots, it is negligible; but occasion arises when it is advisable to laminate the conductors in the upper part of the slot to avoid appreciable loss due to this cause.



Item (2) may lead to very great additional copper losses if solid conductors of large cross-section are used in narrow slots of considerable depth. The calculation of the losses due to the reversals of the slot leakage flux could be made without difficulty if it were not for the fact that the dampening effect of the unequal distribution of the current density through the section of the solid conductor actually decreases the amount of the slot flux and so reduces the loss. The best and most thorough treatment of this subject known to the writer is that of PROF. A. B. FIELD in the *Trans.*, A. I. E. E., vol. 24, p. 761 (1905). The remedy in the case of heavy losses due to slot leakage flux through the copper is to laminate the conductors in a direction parallel to the flux; thus, if copper strip is used, it must not be placed on edge in the slot, but should be laid flat with the thin edge presented to the flux lines crossing the slot, exactly as in the case of the armature stampings, which are so placed relatively to the flux from the poles. Owing to the fact that the leakage flux is considerably greater in amount near the top than the bottom of the slot, the losses due to both causes of flux reversal in the space occupied by the "active" copper are of more importance in the upper layers of conductors than in those near the bottom of the slot. For this reason, the upper conductors will sometimes be laminated, while the lower conductors are left solid. When the method of lamination has been decided upon, the probable increase in loss can be obtained from figures and curves published by PROF. FIELD in the paper previously referred to; but it is suggested that, for the purpose of estimating the probable efficiency, the calculated  $I^2R$  loss in the armature windings be increased 15 per cent. in the case of slow-speed machines of moderate size, and 30 per cent. in the case of steam-turbine-driven units of large output. This addition is intended to cover not only the losses due to eddy currents in the armature windings, but all indeterminate losses in end plates, supporting rings, etc., which increase with the load.

## CHAPTER XV

### EXAMPLE OF ALTERNATOR DESIGN

**112. Introductory.**—The principles and features of alternator design, as given in the foregoing chapters, will now be applied and illustrated in the working out of a numerical example. A steam-turbine-driven three-phase generator will be selected, because this design involves greater departures from the previously illustrated D.C. design than would occur if the slow-speed type of alternator with salient poles were selected. It is true that the difficulties encountered in the design of turbo-alternators—especially of the larger sizes, running at exceptionally high speeds—are of a mechanical rather than an electrical nature; but this merely emphasizes the importance to the electrical engineer of a thorough training in the principles and practice of mechanical engineering.

It is not possible for a man who is not in the first place an experienced mechanical engineer to design successfully a modern high-speed turbo-alternator. These machines are now made up to 30,000 k.v.a. output at 1,500 revolutions per minute (25 cycles) and 35,000 k.v.a. at 1,200 revolutions per minute (60 cycles). Larger units can be provided as the demand arises; it is probable that single units for outputs up to 50,000 k.v.a. at 750 revolutions per minute will be built in the near future. With the great weight of the slotted rotors, carrying insulated exciting coils, and travelling at very high peripheral velocities, new problems have arisen, and these problems should be seriously studied by anyone proposing to take up the design of modern electrical machinery. Engineering textbooks may constitute a basis of necessary knowledge; but, with the rapid advance in this field of electrical engineering, the information of greatest value (apart from what the manufacturing firms deliberately withhold) is to be found in current periodical publications, including the papers and discussions appearing in the journals of the engineering societies.

Since it will not be possible to discuss the mechanical details of turbo-alternator designs in these pages, a machine of medium size (8,000 k.v.a.) will be chosen, and the peripheral speed of the rotor will not be permitted to exceed 18,000 ft. per minute. The mechanical difficulties will therefore not be so great as in



some of the larger machines running at higher peripheral velocities, and the electrical features of the design will be considered alone, reference being made to mechanical details only as occasion may arise.

It is proposed to work through the consecutive items of a design sheet, as was done for the D.C. dynamo; but the sheets will include fewer detailed items, more latitude being allowed in the exercise of judgment and the application of knowledge derived from the work done on previous designs. An attempt will be made to render the example of use in the design of slow-speed salient-pole machines, and, with this end in view, references will be made to the text when taking up in detail the items of the design sheet. For the same reason—namely, to make the numerical example of broad application—the writer may take the liberty of digressing sometimes from the immediate subject, if matters of interest suggest themselves as the work proceeds.

**113. Single-phase Alternators.**—Since the selected design is that of a polyphase machine, it seems advisable to state here one or two matters of special interest in the design of the less common single-phase generator. It is easier to design a polyphase than a single-phase alternator, although this fact is not always recognized, even by designers. Many of the single-phase machines in actual service are less efficient than they might be; but the problems which are peculiar to single-phase generators receive comparatively little attention because these machines are rarely used at the present time, the development during recent years having been mainly in the direction of power transmission and distribution by polyphase currents.

It is the pulsating nature of the armature m.m.f., as explained in Art. 94, Chap. XIII that leads to eddy-current losses that are practically inappreciable in the case of two- or three-phase machines working on a balanced load, that is to say, with the same current and the same voltage in each of the phase windings, and with the same angular displacement between current and e.m.f. in the respective armature circuits. Sometimes the polyphase load is not balanced, and in that case pulsations of the armature field occur as in the single-phase machines, the amount of the pulsating field being dependent upon the degree of unbalancing of the load. The effect is then as if an alternating field were superposed on the steady armature m.m.f. due to the balanced components of the total armature current.

Without going into detailed calculations, it may be stated that

the remedy consists in providing amortisseur—or damper—windings on the pole faces, as mentioned in Art. 94, Chap. XIII. A simple form of damper is illustrated in Fig. 134, where a number of copper rods through the pole face—and on each side of

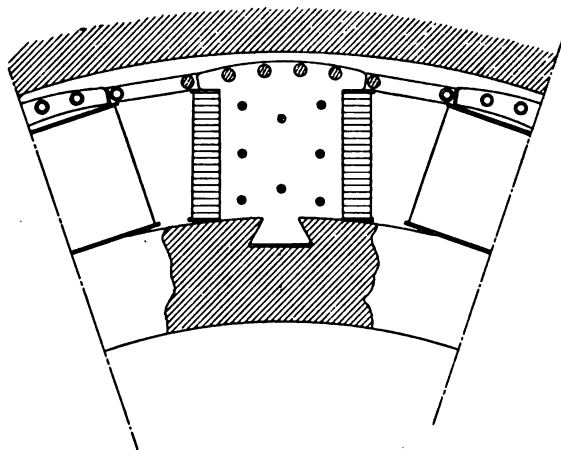

FIG. 134.—Short-circuited damping bars in pole face of single-phase alternator.

the pole shoe—are short-circuited at both ends by heavy bands of copper. Any tendency to sudden or periodic changes of flux through any portion of the pole face is checked to a very great extent by the heavy currents that a small change of flux will establish in the short-circuited rods.

114.—Design Sheets for Alternating-current Generator.—

SPECIFICATION

Output, k.v.a.....	8,000
Number of phases.....	3
Terminal voltage.....	6,600
Power factor of load.....	0.8
Frequency.....	60
Type of drive.....	Steam turbine
Speed, r.p.m.....	1,800
Inherent regulation.....	Within 25 per cent. rise when full load is thrown off.
Exciting voltage.....	130
Permissible temperature rise after 6 hr. full-load run (by thermometer).....	45°C.
Ventilating fan.....	Independently driven (not part of generator).

GENERAL OUTLINE OF PROCEDURE

- (a) Design armature.
- (b) Design field magnets.
- (c) Draw flux distribution curves. Obtain wave shapes and form factors.
- (d) Complete field system. Open-circuit saturation curve. Regulation, and short-circuit current.
- (e) Efficiency.



EXAMPLE OF ALTERNATOR DESIGN

CALCULATIONS

	Sym-bols	Assumed or approximate values	Final values
1. Number of poles.....	$p$	.....	4
2. Peripheral speed (feet per minute).....	$v$	18,000	
3. Diameter of rotor (inches).....		38.2	38.25
4. Line current.....	$I$	.....	700
5. Phase connection (star or delta).....		$Y$	$Y$
6. Specific loading.....	$q$	812	800
7. Current in armature conductors.....	$I_a$	.....	700
8. Armature ampere-turns per pole.....	$(SI)_a$	12,750	11,340
9. Length of air gap at center (inches).....	$\delta$	$\frac{3}{4}$	$\frac{3}{4}$
10. Diameter of stator (armature) (inches).....	$D$	40	40
11. Pole pitch (inches).....	$\tau$	.....	31.416
12. Pole arc (inches).....	Distributed winding		
13. Number of inductors per phase.....	$Z$	48.7	48
14. Number of armature slots per pole per phase.....	$n$	4	4
15. Slot pitch.....	$\lambda$	2.62	2.62
16. Number of inductors per slot.....	$T_s$	3	3
17. Flux per pole (no load).....	$\Phi$	.....	$62.2 \times 10^6$
18. Average flux density over pole pitch (open circuit).....	$B_g$	6,000	5,910
19. Axial length of armature core { gross (inches).....	$l_a$	51	51
net (inches).....	$l_n$	.....	46.8
20. Axial length of pole face (inches).....	.....	.....	49 $\frac{1}{4}$
21. Determine style of winding.....	Single layer		
22. Current density in armature conductors.....	$\Delta$	2,000	2,000
23. Size of conductor. How made up. Slot insulation (inches).....	.....	.....	$4 \times \frac{1}{2} \times 0.14$
24. Tooth and slot proportions.			
25. Width of armature slot (inches).....	$s$	.....	1
26. Depth of armature slot (inches).....	$d$	.....	$4\frac{1}{4}$
27. Apparent tooth density (no load) at center of tooth.....	.....	.....	14,800
28. Flux density in armature core.....	.....	.....	8,500
29. Radial depth of armature core below teeth (inches).....	$R_d$	.....	14
30. Weight of core (iron) (pounds).....	.....	.....	28,000
31. Weight of teeth (iron) (pounds).....	.....	.....	4,900
32. Total core loss, including teeth (open circuit).....	.....	.....	120 kw.
33. Length mean turn of armature coils (inches).....	.....	.....	210
34. Resistance per phase (ohms).....	.....	.....	0.01135
35. $IR$ drop per phase (full-load current).....	volts	.....	8.4
36. Total armature copper loss (full-load current) kw.....	.....	.....	21
37. $IX$ drop (ends)—volts per phase winding.....	$E_g P$	.....	116
38. $IX$ drop (slots)—volts per phase winding.....	$E'_g E_g$	.....	190
39. Full-load developed voltage (per phase winding).....	.....	3,875	3,875
40. Full-load flux per pole.....	.....	$65.2 \times 10^6$	$65.2 \times 10^6$
41. Shaping of pole face.....	(Cylindrical)		
42. Number of slots per pole (rotor).....	.....	8	8
43. Slot pitch (rotor).....	.....	3.76	3.76
44. Slot width (rotor).....	.....	1.625	1.625
45. Permeance per square centimeter of air gap (center).....	.....	.....	0.3059
46. Equivalent air gap at center (inches).....	$\delta_e$	.....	1.25
47. "Actual" tooth density in terms of air-gap density.....	Fig. 137	.....	.....
48. Saturation curves for air gap, teeth, and slots.....	Fig. 139	.....	.....
49. Permeance curve (if salient-pole design).....	.....	.....	.....
50. Open-circuit flux curve $A$ .....	Fig. 141	.....	.....
51. M.m.f. curve for flux curve $A$ .....	Fig. 142	.....	.....
52. Required area of full-load flux curve $C$ .....	.....	.....	122.3

## CALCULATIONS.—Continued

	Symbols	Assumed or approximate values	Final values
53. Resultant m.m.f. for flux curve <i>C</i> .....	Fig. 142		
54. Full-load flux curve <i>C</i> .....	Fig. 141		
55. E.m.f. wave shapes at no load and full load.....	Figs. 143, 144		
56. Form factor, no load.....			
57. Form factor, full load.....			1.10
58. Complete field-magnet design.....			
59. Flux leakage coefficient.....	<i>l<sub>f</sub></i>	1.15	
60. Cross-section of pole cores.....			
61. Cross-section of yoke ring.....			
62. Open-circuit saturation curve for complete magnetic circuit.....	Fig. 146		
63. Ampere-turns (per pole) on field; no load.....			27,000
64. Ampere-turns (per pole) on field; full load.....			37,000
65. Field-magnet winding.....			$1\frac{1}{4} \times 0.12$
66. Current in field winding (no load).....			375
67. Current in field winding (full load).....			514
68. <i>I</i> <sup>2</sup> <i>R</i> loss (field); full load.....			66 kw.
69. Total cross-section of air ducts (forced ventilation).....			6.6 sq. ft.
70. Inherent regulation (full-load current) (full- load current) { Unity power factor... Specified power factor... Zero power factor...}			22 per cent.
71. Short-circuit current (per phase winding) with full-load excitation (amperes).....			1,950
72. Efficiency at full load and specified power factor.....			0.955
73. Efficiency at fractional loads.....			
74. Approximate volume of air required (forced ventilation)—cubic feet per minute.....			29,000
75. Average velocity of air in ventilating ducts—feet per minute.....			4,400

**115. Numerical Example.—Calculations.—***Items* (1) to (11). With a frequency of 60 cycles per second and a speed of 1,800 revolutions per minute, the number of poles is

$$p = \frac{2 \times 60 \times 60}{1,800} = 4$$

At a peripheral velocity of 18,000 ft. per minute, the diameter of the rotor would be  $\frac{18,000 \times 12}{1,800 \times \pi} = 38.2$  in.

Since the air gap is not likely to be less than 1 in., let us decide upon an internal diameter of the armature  $D = 40$  in. (item (10)), and determine the exact dimensions of the rotor after the air gap has been decided upon.

The line current (item (4)) is

$$I = \frac{800,000}{\sqrt{3} \times 6,600} = 700 \text{ amp.},$$

and if we select the star connection of phases, this is also the current per phase winding (item (7)).

Referring to Art. 75 for values of the specific loading (page 250) we find that the average value there suggested is  $q = 650$ ; but the peripheral loading is greater in turbo-alternators than in slow-speed salient-pole machines, because it is desired to keep the axial length as short as possible, and the greater losses per unit area of cooling surface can be dealt with by a suitable system of forced ventilation. We may therefore select a value for  $q$  equal to, or even greater than, the proposed maximum for self-cooled machines. Let us try  $q = 650 \times 1.25 = 812$ .

The pole pitch (item (11)) is

$$\tau = \frac{\pi \times 40}{4} = 31.416 \text{ in.}$$

and the approximate armature ampere-turns per pole (item (8)) will be

$$(SI)_a = \frac{31.42 \times 812}{2} = 12,750$$

Referring to Arts. 76 and 77, Chap. XI, we can get a preliminary idea of the required length of air gap as explained in Art. 77. We shall, in this design, deliberately select a high value for the air-gap flux density, and if necessary saturate the teeth of the rotor while keeping the density in the armature teeth within reasonable limits to prevent excessive hysteresis and eddy-current loss. Let us try  $B_g = 6,000$  gausses, which is higher than the upper limit of the range suggested in Art. 76. The principal advantage of using high flux densities is that the axial length of the rotor can thus be reduced; but if it is found later that the selected value of  $B_g$  leads to unduly high flux density in the stator teeth, it will have to be modified.

The probable maximum value of the air-gap density on open circuit is  $\frac{\pi}{2} \times 6,000 = 9,450$  gausses; and, assuming the ratio of m.m.fs. to be 1.25, we have

$$9,450 \times \delta \times 2.54 = 1.25 \times 0.4\pi \times 12,750$$

whence  $\delta = 0.835$  or (say)  $\frac{7}{8}$  in.

In the case of medium-speed salient-pole designs, the peripheral velocity would not be decided upon by merely selecting the upper limit of 8,000 ft. per minute as given in Art. 66 (page

238). This has to be considered in connection with the pole pitch (see Art. 74), a preliminary diameter of rotor being selected in keeping with what seems to be a reasonable pole pitch. A few rough calculations will very soon show whether or not the tentative value of  $\tau$  will lead to a suitable axial length of armature core.

*Items (13) to (16).*—On the basis of  $q = 812$ , the number of conductors per phase would be

$$Z = \frac{1}{3} \left( \frac{\pi D q}{I_a} \right) = 48.7$$

With four slots per pole per phase, and three conductors in each slot, we have  $Z = 3 \times 4 \times 4 = 48$ .

For item (15) we have  $\lambda = \frac{31.416}{12} = 2.62$  in., giving a corrected value for peripheral loading of  $q = \frac{700 \times 3}{2.62} = 800$  approx.

*Items (17) to (20).*—For the purpose of calculating the flux required on open circuit, we may use formula (94) of Art. 70, where  $E_{\text{per phase}} = \frac{6,600}{\sqrt{3}}$ , and  $k = 0.958$ .

The required flux per pole is therefore

$$\begin{aligned} \Phi &= \frac{6,600 \times 10^8}{\sqrt{3} \times 2.22 \times 0.958 \times 60 \times 48} \\ &= 62.2 \times 10^6 \text{ maxwells.} \end{aligned}$$

With the assumed value of 6,000 gaussess for  $B_p$ , the axial length of armature core will be

$$l_a = \frac{62.2 \times 10^6}{6,000 \times 6.45 \times 31.42} = 51 \text{ in.}$$

This is a short armature for a machine with a rotor 38.25 in. in diameter; but it is what we are aiming at, and if the field winding can be accommodated in the space available, the design should be satisfactory.

We shall attempt to ventilate this generator by means of axial air ducts only. If, then, there are no radial air spaces, the net length of iron in the armature core will be approximately  $l_n = 0.92l_a = 46.8$  in. (Art. 84); but these dimensions cannot be finally decided upon until the slot proportions and tooth densities have been settled.

*Whirling Speed of Rotor.*—A matter of considerable impor-



tance in the design of high-speed machinery is the particular speed at which vibration becomes excessive. Without attempting to go into the mechanical design of shaft and bearings, it should be pointed out that the size of shaft in turbo-alternators is determined mainly by what is known as the whirling speed, which, in turn, depends upon the deflection of the rotor considered as a beam with the points of support at the centers of the two bearings. There will be one or more critical speeds at which the frequency of the bending due to the weight of the rotating part will correspond exactly with the natural frequency of vibration of the shaft considered as a deflected spring. The vibration will then be excessive, causing chattering in the bearings and abnormal stresses which may lead to fracture of the shaft.

The maximum deflection of the rotor due to its own weight together with the unbalanced magnetic pull (if any) can be calculated within a fair degree of accuracy when the position of the bearings and the cross-section of the shaft are known. The whirling speed of a rotor with steel shaft, in revolutions per minute, can then be calculated, because it is approximately

$$\frac{190}{\sqrt{\text{Deflection in inches}}}$$

In turbo-alternators the whirling speed is generally higher than the running speed; but this is not a necessary condition of design; and in direct-current steam-turbine-driven dynamos, where the provision of a commutator calls for the smallest possible diameter of shaft, the whirling speed is commonly lower than the normal running speed. In such cases it is necessary to pass through the critical speed, causing vibration of the rotor, every time the machine is started or stopped; but this is not a serious objection. A good rule is to arrange for the whirling speed to be either 25 per cent. above, or 25 per cent. below, the running speed. Taking as an example the design under consideration, the whirling speed should be either  $1,800 + 25 \text{ per cent.} = 2,250$ ; or  $1,800 - 25 \text{ per cent.} = 1,350$ . In the first place the permissible deflection would be  $\left(\frac{190}{2,250}\right)^2 = 0.00714 \text{ in.}$ ; and in the second case it would be  $\left(\frac{190}{1,350}\right)^2 = 0.0198 \text{ in.}$

By making a very rough estimate of the rotor weight and the span between bearings, it will be seen that the smaller deflection

(corresponding to the higher critical speed) is easily attainable, the diameter of the shaft being of the order of 13 in. near the rotor body, and  $10\frac{1}{2}$  in. in the bearings. It is not proposed to go further into details of mechanical design; but attention may be called to the fact that a rotor forged solid with the shaft, or a solid rotor with the shaft projections bolted to the two ends, (*i.e.*, without a through shaft), is stiffer than a laminated rotor with through shaft. We shall assume a solid rotor in this design, although the length of the rotor body (about  $49\frac{1}{2}$  in.), being less than one and one-half times the diameter, would indicate the feasibility of a rotor built up of steel plates.

*Items (21) to (27).*—On account of our having an odd number of conductors per slot, we shall decide upon a single layer winding (see Art. 78, Chap. XII). The current density in the armature windings cannot be determined by the empirical formula (96) of Art. 81, because this is not applicable to speeds higher than 8,000 ft. per minute, and in any case, the conditions of cooling in an enclosed machine with forced ventilation are not the same as for a self-ventilating generator. In a turbo-alternator there is usually plenty of room for the armature conductors, the chief trouble being with the rotor winding, which may have to be worked at a high current density. There is no definite rule for the most suitable current density in the armature conductors, the permissible copper cross-section being dependent on the length of armature core, the position and area of the vent ducts, and the supply of air that can economically be passed through the machine. The specific loading will obviously have some effect on the allowable current density in the copper; and, as a guide in making a preliminary estimate, we may use the formula

$$\Delta = \frac{160,000}{q}$$

which gives us for item (22) a current density of 2,000 amp. per square inch of armature copper.

It is well to laminate the conductors in a direction parallel to the slot leakage flux (see Art. 88, page 267, and Art. 111, page 318), and we may build up each conductor of four flat strips each  $\frac{5}{8}$  by 0.14 in., giving a total cross-section of 0.35 sq. in. per conductor.

There will be 12 copper strips in each slot, the total thickness, including the cotton insulation, being about 1.92 in. The slot

insulation should be about 0.16 in., or  $\frac{5}{32}$  in., thick (see Art. 80, page 259), and the total slot space for winding and insulation will be 1 in. wide by  $2\frac{1}{4}$  in. deep. The thickness of wedge might

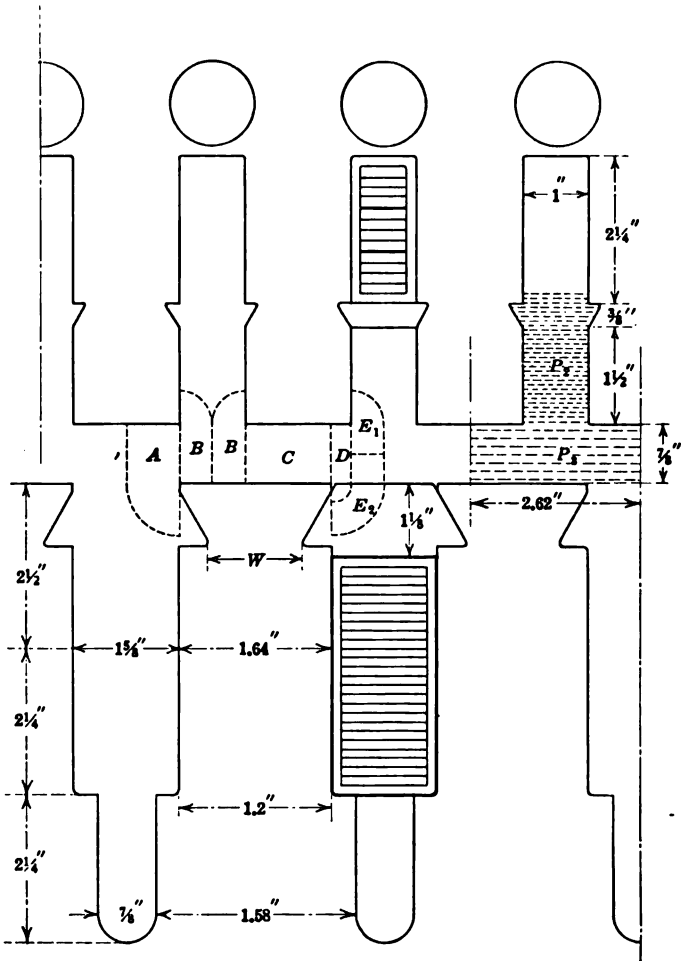

FIG. 135.—“Developed” section through stator and rotor teeth of 8000 k.v.a. turbo-alternator.

be  $\frac{3}{8}$  in., and we shall, in this design, allow an extra slot depth of  $1\frac{1}{2}$  in. above the wedge, with a view to increasing the slot inductance, and so limiting the instantaneous rush of current in the event of a short-circuit. This increased armature induc-

tance might have been obtained by using a smaller width and greater depth of copper conductor; but, seeing that the width of tooth will probably be sufficient, the proposed design of slot (as shown in Fig. 135) has the advantage that the eddy-current loss in the armature inductors, from both causes referred to in Art. 111 (page 318), will be very small.

The width of copper strip was selected to fit into the 1-in. slot, because this seems to provide a suitable cross-section for the stator tooth. Thus, a section halfway down the tooth, or (say) 2 in. from the top, will have a diameter of 44 in., and the average width of tooth will be  $\frac{\pi \times 44}{48} - 1 = 1.88$  in. On the basis of  $B_p = 6,000$  gausses, and a sinusoidal flux distribution over the pole pitch, the "apparent" tooth density (item (27)) would be  $\frac{\pi B_p \lambda_a}{2 l_n} = \frac{\pi \times 6,000 \times 2.62 \times 51}{2 \times 1.88 \times 46.8} = 14,300$  gausses which is not too high (see Art. 76, page 251).

*Items (28) to (32).*—Assuming a flux density of 8,500 gausses in the armature core (see Art. 88, Chap. XII), the net radial depth of stampings below the slots will be

$$\frac{62.2 \times 10^6}{2 \times 8,500 \times 6.45 \times 48.8} = 11.6 \text{ in.}$$

The actual radial depth should be greater than this to allow for the reduction of section due to the presence of axial vent ducts. In this particular machine it is proposed to ventilate, if possible, with axial ducts only, and a fairly large cross-section of air passages must therefore be allowed. An adequate supply of air will probably be obtained if the total cross-section of air duct through the body of the stampings (in square inches) is not less than  $0.005 \times$  cubic inches of iron in stator below slots. In this case the volume of iron in the stator ring will be approximately  $\pi(48.25 + 11.6) \times 11.6 \times 46.8 = 102,000$  cu. in.; and the total cross-section of air ducts in the stampings should be  $0.005 \times 102,000 = 510$  sq. in.

The actual radial depth of stamping below the teeth can be calculated by assuming that the air ducts reduce the gross depth by an amount equal to  $\frac{510}{\text{average circumference}}$ , or (say)  $\frac{510}{\pi \times 62} = 2\frac{5}{8}$  in. approximately. Let us make the depth  $R_d$  (item (29)) = 14 in., and provide vent ducts arranged generally as shown in Fig.



136, where there are 10 holes per slot, each  $1\frac{1}{4}$  in. in diameter, making a total of  $\frac{\pi}{4} (1.25)^2 \times 10 \times 48 = 589$  sq. in.

The weight of iron in core (item 30) is

$$0.28 \times 46.8 \times [\pi(38.125^2 - 24.125^2) - 589] = 28,000 \text{ lb., approximately.}$$

The weight of the iron in the teeth (item (31)) is

$$0.28 \times 46.8 \times [\pi(24.125^2 - 20^2) - (48 \times 1 \times 4.125)] = 4,900 \text{ lb.}$$

Taking the approximate flux densities as previously calculated (items 27 and 28), and referring to the iron-loss curve, Fig. 34,

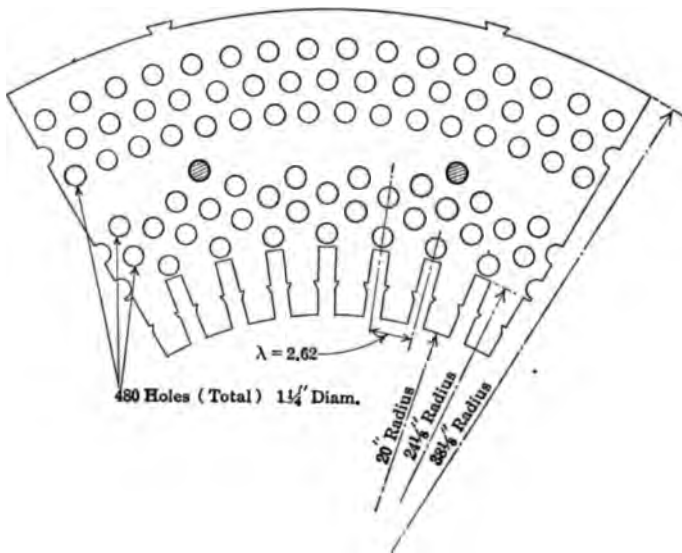

FIG. 136.—Armature stamping of 8000 k.v.a. turbo-alternator.

page 102, the iron loss per pound for carefully assembled high-grade armature stampings is found to be 6.1 and 3.2 watts in teeth and core respectively. The loss in the teeth is therefore  $6.1 \times 4,900 = 30,000$  watts, and in the core below the teeth,  $3.2 \times 28,000 = 90,000$  watts, making a total of 120 kw., or 1.5 per cent. of the rated output, which is not excessive although quite high enough for a machine of 8,000 kw. capacity.

*Items (33) to (36).*—In a machine of so large an output as the one under consideration, the weight and cost of copper should be

determined by making a drawing of the armature coils and carefully measuring the length required. Since this design is being worked out for the purpose of illustration only, we shall use the formula (97) of page 261, and assume the length per turn of armature winding (item (33)) to be

$$(2 \times 51) + (2.5 \times 31.42) + (2 \times 6.6) + 6 = 199.8 \text{ in.}$$

It will be safer to use the figure 210 in. for this mean length, because all the coils will probably be bent back and secured in position by insulated clamps in order to resist the mechanical forces which tend to displace or bend the coils when a short-circuit occurs.

The cross-section of the conductor (four strips in parallel) is 0.35 sq. in., or 445,000 circular mils. The number of turns per phase is 24, and the resistance per phase at 60°C. is, by formula (21), page 36,  $\frac{210 \times 24}{445,000} = 0.01135$  ohm. The  $IR$  drop per phase (item (35)) is  $0.01135 \times 700 = 7.95$ , or (say) 8.4 volts in order to include the effect of eddy currents in the conductors. The  $I^2R$  loss in armature winding (item 36) is  $3 \times 0.01135 \times (700)^2 = 16,700$  watts, which should be increased about 25 to 30 per cent. (see Art. 111, Chap. XIV) to cover sundry indeterminate load losses. The total full-load armature copper loss may therefore be estimated at 21 kw., or 0.26 per cent. of the rated full-load output; which is about what this loss usually amounts to in a turbo-generator of 8,000 k.v.a. capacity.

*Items (37) and (38).*—The reactive voltage drop per phase due to the cutting of the end flux cannot be predetermined accurately; but we may use the empirical formula (99) page 266, wherein the symbols have the following numerical values.

The constant  $k$  will be fairly high in turbo-alternators, and we shall assume the value  $k = 1.5$ . For the other symbols we have:

$$\begin{aligned} f &= 60 \\ p &= 4 \\ T_s &= 3 \\ n_s &= 4 \\ I_c &= 700 \end{aligned}$$

In regard to  $l_e$  and  $l'$ , the mean length per turn (item (33)) was assumed to be 210 in. The length  $l_e$  is therefore  $210 - 2l_a$  or,  $l_e = (210 - 102) \times 2.54 = 275$  cm.

The average projection beyond ends of slots measured along the side of the coil, whether straight or bent, is

$$l' = \frac{l_c - 2r}{4} = \frac{275 - (63 \times 2.54)}{4} = 28.8 \text{ cm.}$$

The reactive voltage due to cutting of end flux, with full-load current per phase, is then

$$2.22 \times 1.5 \times 60 \times 4 \times 9 \times 275 \times \left(\frac{24}{9}\right) \log_{10} (12 \times 4 \times 28.8) \\ \times 700 \times 10^{-8} = 116 \text{ volts.}$$

The loss of pressure due to the slot flux can be calculated as explained in Art. 97 using formula (106) on page 288, wherein the quantities  $f$ ,  $p$ ,  $T_s$ ,  $n_s$ , and  $I_c$  have the same numerical values as in the formula for end-flux reactive voltage. The remaining quantities are: the gross core length  $l_a = 51 \times 2.54 = 129.5$  cm.,  $d_1 = 2\frac{1}{8}$  in., and  $s = 1$  in. The permeances  $P_2$  and  $P_3$  of the flux paths in the air spaces above the conductors can be calculated as follows. Neglecting the widening of the slot to accommodate the wedge, the permeance of the slot above the winding (see Fig. 135) is  $P_2 = \frac{2 \times 1}{1} = 2$ , per centimeter length of armature core measured parallel to the shaft. The permeance of the path from tooth top to tooth top may be calculated by assuming the m.m.f. of one armature slot to set up the flux in an air space of radial depth  $\delta = \frac{3}{8}$  in., and of length  $\lambda = 2.62$  in. Thus  $P_3 = \frac{7 \times 1}{8 \times 2.62} = 0.334$ . This last quantity cannot have a numerical value smaller than as calculated by this method. If the rotor teeth were built up of thin plates like the stator, the numerical value of  $P_3$  would be greater than 0.334; but we are assuming a solid steel rotor (which is customary), and for this reason it will be best to neglect the flux paths through the iron of the rotor teeth. We are concerned mainly in providing enough armature reactance to keep the short-circuit current within reasonable limits, and as a sudden growth of leakage flux is impossible in solid iron owing to the demagnetizing effect of the eddy currents produced, the value for  $P_3$  as here calculated will be about right.

By inserting all these numerical values in formula (106), we get for the volts lost by slot leakage when the armature conductors are carrying full-load current,  $E_s = 189$ , or (say) 190 volts.

Items (39) and (40).—We are now in a position to draw a vector diagram similar to Fig. 115 for any power-factor angle  $\theta$ , the calculated numerical values of the component vectors being:

$$\begin{aligned} OE_t &= \frac{6,600}{\sqrt{3}} = 3,810 \\ E_tP &= 8.4 \\ PE_g &= 116 \\ E_gE'_g &= 190 \end{aligned}$$

For a given terminal voltage of 6,600 (or 3,810 volts as measured between terminal and neutral point) the required developed voltage will be a maximum when the external power-factor angle is equal to the angle  $E_gE_tP$  because the additional voltage to be generated will then be  $E_tE_g$ , which, in this particular example,

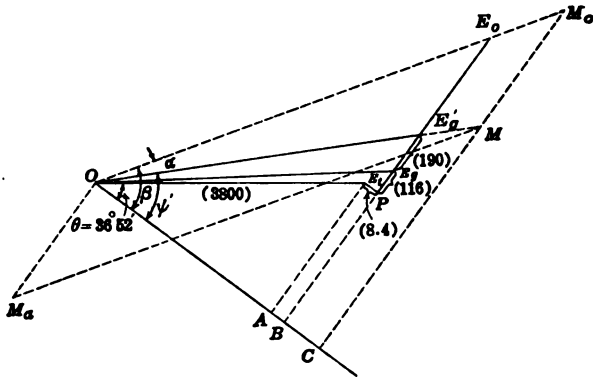

FIG. 137.—Vector diagram for 8000 k.v.a. turbo-alternator.

amounts to  $\sqrt{(8.4)^2 + (116)^2} = 116.4$  volts, the effect of the armature resistance being negligible as compared with the reactance of the end connections.

For 80 per cent. power factor, as mentioned in the specification, the angle  $\theta$  will be  $36^\circ 52'$ , and the developed voltage per phase winding (see Fig. 137) is

$$OE'_g = \sqrt{(OB)^2 + (BE'_g)^2}$$

where  $OB = OA + AB = OE_t \cos \theta + E_tP$

and  $BE'_g = BP + PE_g = OE_t \sin \theta + PE_g$ .

Similarly, for calculating the full-load flux per pole (see Art. 99) we have:

$$\text{“ Apparent ” developed voltage} = OE'_g = \sqrt{(OB)^2 + (BE'_g)^2}$$



Solving for the numerical values, we get:

$$OE_o = 3,875 \text{ volts (item (39))}$$

and

$$OE'_o = 4,000 \text{ volts.}$$

The full-load flux per pole (item (40)) is therefore,

$$\begin{aligned} \frac{\text{Item (17)} \times OE'_o}{OE_o} &= \frac{62.2 \times 10^6 \times 4,000}{3,810} \\ &= 65.2 \times 10^6 \text{ maxwells.} \end{aligned}$$

*Item 41.*—Since we have decided upon a cylindrical rotor, the variation of flux density over the pole pitch must be obtained by distributing the field winding in slots on the rotor surface; but in the design of salient-pole machines, the pole face should be shaped as explained in Art. 90 (page 269), and the approximate dimensions of the pole core should be decided upon with a view to providing sufficient space for the exciting coils. The cross-section of the pole cores would be determined as in the case of continuous-current dynamos by calculating or assuming a leakage factor (see Art. 103, Chap. XIV) and deciding upon a flux density in the iron (about 14,000 or 15,500 gausses).

*Items (42) to (44).*—Let us try a rotor as shown in Fig. 103, with eight slots per pole, only six of which are wound, leaving two slots without winding at the center of each pole. The slot pitch (item (43)) is therefore  $\frac{\pi \times 38.25}{32} = 3.76$  in. This dimension expressed in terms of the stator diameter is  $\frac{\lambda \times 12}{8} = 3.93$  in.

The slot width may be decided upon by arranging for a fairly high density in the rotor teeth. Thus, the open-circuit flux (item (17)) which passes through a total of eight teeth is  $62.2 \times 10^6$  maxwells. If  $t_r$  is the average width of rotor tooth, in inches, the average tooth density in maxwells per square inch is  $B'' = \frac{62.2 \times 10^6}{8 \times t_r \times 49.5}$ , which must be multiplied by  $\frac{\pi}{2}$  to obtain the approximate maximum density in the teeth near the center of the pole. Neglecting leakage flux, and assuming  $B''_{\text{max.}} = 120,000$ , the tooth width  $t_r$  will be 2.06 in., which indicates that a slot  $1\frac{5}{8}$  in. wide will probably be suitable.

Before deciding upon the depth of rotor slot, it will be advisable to calculate the equivalent air gap in order that the field ampere-turns and necessary cross-section of copper may be determined.

The thickness of wedge for keeping the field windings in position might be about  $1\frac{1}{8}$  in. as shown in Fig. 135; but as the centrifugal force exerted upon it by the copper in the slot may be very great on account of the high peripheral velocity, careful calculations should be made to determine the compression and bending stresses in the wedge. The allowable working stress for manganese-bronze or phosphor-bronze wedges is about 14,000 lb. per square inch.

Although we are not designing a single-phase turbo-alternator, it may be stated here that a convenient means of providing amortisseur or damping windings on the rotors of single-phase machines (see Art. 113) is to use copper wedges in the slots and connect them all together at the ends by means of substantial copper end rings.

While discussing the matter of rotor slot design, the question of stresses in the rotor teeth should be mentioned. After the slot depth has been decided upon, the centrifugal pull on the rotor tooth should be calculated and the maximum stress in the steel determined, the slot proportions being modified if this stress exceeds 14,000 lb. per square inch for cast steel or 16,000 lb. per square inch for mild steel. The total centrifugal pull at the root of one tooth is due to the weight of the tooth plus the contents of one slot, including the wedge, while the pull at the narrow section near the top of tooth (the width  $W$  in Fig. 135) is due to the contents of one slot plus the wedge and the portion of the tooth above the section considered.

*Items (45) and (46).*—The calculation of the average permeance of the air gap between rotor and stator is carried out as explained in Art. 93 of Chap. XIII. The approximate paths of the flux lines are shown in Fig. 135 which is a “developed” section through the stator and rotor teeth; that is to say, no account is taken of the curvature of the air gap, the tooth pitch on the rotor being made exactly equal to 1.5 times  $\lambda$ , namely 3.93 in., or 10 cm. The actual air gap from tooth top to tooth top (item (9)) is  $\delta = 0.875$  in., and if we neglect the slightly increased reluctance due to the angle of the tooth sides under the wedge, the component flux paths may be thought of as made up of straight lines, or of straight lines terminating in quadrants of circles. The permeance of each section of the flux path between stator and rotor over a space equal to the rotor slot pitch is easily calculated as explained in Art. 5, Chap. II (cases *a* and *c*). The calculated nu-

merical values of the permeances per centimeter of air gap measured axially are:

Path A =	0.5725
Path B =	0.408
Path B =	0.408
Path C =	1.063
Path D =	0.2845
Path E =	0.323
Total =	<u>3.059</u>

The permeance per square centimeter cross-section of air gap is therefore  $\frac{3.059}{10} = 0.3059$ , and the equivalent air gap is  $\delta_e = \frac{1}{0.3059} = 3.27$  cm., or 1.285 in. If great accuracy is required, a similar set of calculations should now be made with the relative position of rotor and stator teeth slightly changed so as to bring the center lines of two teeth to coincide, instead of the center lines of two slots as shown in Fig. 135, and the mean of the two calculated values will more nearly correspond with the average air-gap permeance. The actual permeance is always somewhat greater than the value obtained from calculations based on certain conventional assumptions regarding the flux paths, and we may take the equivalent air gap to be  $\delta_e = 1.25$  in.

Should any difficulty be experienced in calculating the permeance of a flux path such as *E*, with curved flux lines at both ends, it is always permissible to divide it in two parts as indicated by the letters *E*<sub>1</sub> and *E*<sub>2</sub> in Fig. 135, the permeance of each part being calculated separately. Thus, in the example which has just been worked out, the permeance of *E*<sub>1</sub> is 0.686, and the permeance of *E*<sub>2</sub> is 0.612. The total of 0.323 is obtained by taking the reciprocal of the sum of the reluctances.

*Item (47).*—The calculations for the curves of Fig. 138 have been carried out in the same way as for Fig. 81 (item (70), Art. 63, Chap. X), using formula (62) of Art. 37 for obtaining the approximate relation between air-gap and tooth densities when the iron is nearly saturated. A curve must be plotted for the rotor teeth as well as for the stator teeth; indeed it is in the rotor teeth that the difference between “apparent” and actual density in the iron will be most marked, since it is there that the flux density will attain the highest values. In practice it will rarely be neces-

sary to take account of the effects of saturation in the stator teeth of alternators, because with the comparatively low flux densities—especially in 60-cycle machines—no serious error will

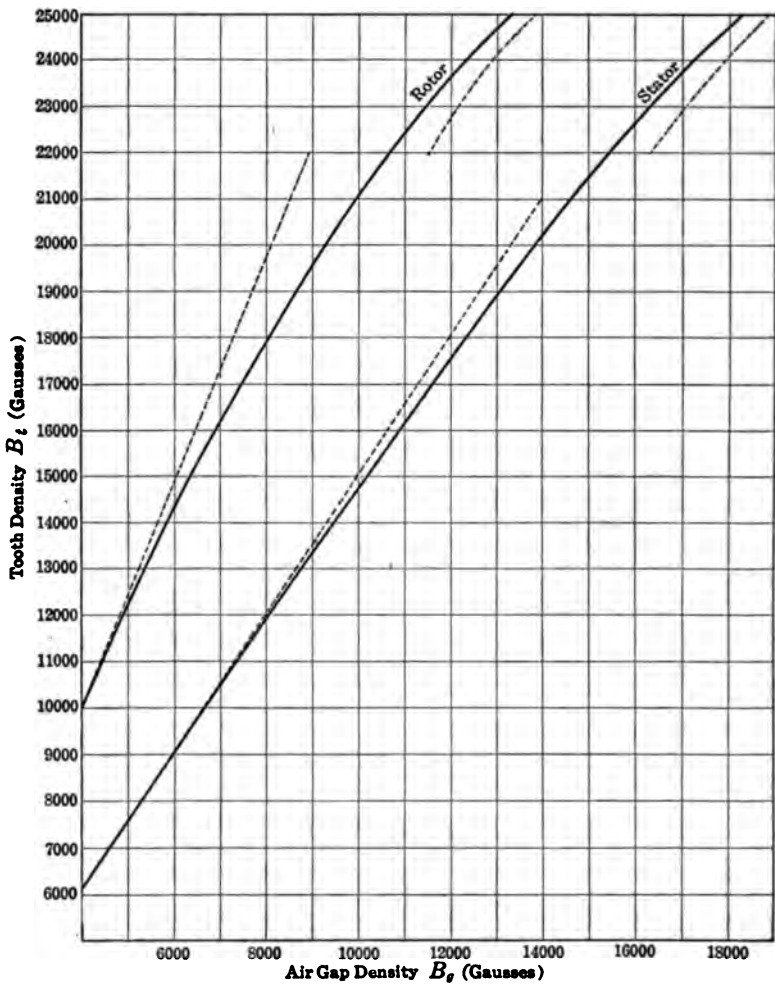

FIG. 138.—Tooth densities in terms of air-gap density—8000 k.v.a. turbo-alternator.

be introduced by using the “apparent” tooth density in the calculations.

The depth of slot in rotor can be approximately determined as follows:



With an equivalent air gap  $\delta_e = 1.25$  in. and an assumed sinusoidal flux distribution, the field ampere-turns on open circuit to overcome the reluctance of air gap only will be

$$SI = \frac{62.2 \times 10^6 \times \pi}{(51 \times 31.42 \times 6.45) \times 2} \times \frac{1.25 \times 2.54}{0.4 \pi} = 24,000$$

which makes the ampere-conductors per slot  $\frac{24,000}{3} = 8,000$ .

This does not include the ampere-turns to overcome the reluctance of the teeth and the remainder of the magnetic circuit, neither does it take into account the considerable increase of excitation with full-load current on a power factor less than unity. The current density in the copper may, however, be carried up to 2,500 or even 3,000 amp. per square inch of copper cross-section, and it is probable that a slot 5 in. deep will provide sufficient space for the field winding.

The numerical value of the symbol  $\delta$  in formula (62) should be something greater than the actual clearance of  $\frac{7}{8}$  in. between the tops of the teeth on armature and field magnet, and since the difference between the equivalent and actual air gap is  $\frac{3}{8}$  in., we may suppose the effect of slotting the surfaces to be equivalent to removing  $\frac{3}{16}$  in. from both stator and rotor. Thus the numerical value of  $\delta$  for use in formula (62) will be  $\frac{7}{8}$  in. +  $\frac{3}{16}$  in. =  $1\frac{1}{16}$  in. If we take the tooth width at a point halfway down the tooth, the symbols in formulas (62) and (63) have the following values:

$$\begin{aligned} \delta &= .0625 \text{ in.} \\ \text{Stator} &\begin{cases} t = 1.89 \text{ in.} \\ d = 4.125 \text{ in.} \end{cases} \\ \text{Rotor} &\begin{cases} t = 1.64 \text{ in.} \\ d = 5.0 \text{ in.} \end{cases} \end{aligned}$$

Since we are considering the air-gap density over the surface of the stator, the slot pitch for the rotor has been taken as  $\lambda = 3.93$ , or one and one-half times the stator slot pitch. As there are no radial vent ducts in the rotor, the ratio  $\frac{l_m}{l_a}$  in formula (62) may be taken as

$$\frac{\text{Axial length of rotor}}{\text{Gross length of armature}} = \frac{49.5}{51} = 0.97.$$

*Item (48).*—With equally spaced slots around the rotor—including the unwound portions of the pole face—only one satura-

tion curve for air gap, teeth and slots need be drawn. This curve (Fig. 139) is constructed as explained in Art. 42, the construction having previously been illustrated in connection with the example in dynamo design (item (71), Art. 63, Chap. X). The ampere-turns per inch length of tooth are read off Figs. 3 and 4; and SIMPSON'S rule (see Art. 38, formula 64) is used in calculating the ampere-turns required for the rotor teeth at the higher densities. In regard to the stator teeth, the mean value of the tooth density may be used in determining the ampere-turns required; the application of SIMPSON'S rule being in this

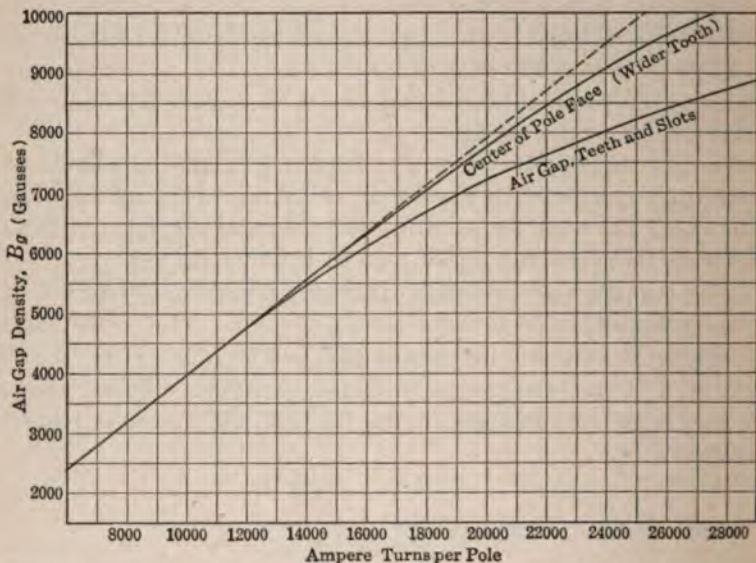

FIG. 139.—Saturation curves for air-gap teeth, and slots—8000 k.v.a. turbo-alternator.

case an unnecessary refinement.<sup>1</sup> In calculating the tooth reluctance for plotting the saturation curve Fig. 138, no correction for leakage flux has been made. It is true that the total flux in the body of the rotor is somewhat greater than the useful flux entering the armature; but the omission of this correction may be set against the fact that the tooth density calculations

<sup>1</sup> In most cases, the practical designer—who cannot afford to spend much time on refinements of calculation—calculates the density at a section one-third of the tooth length measured from the narrowest end, and he uses this value in getting an approximate average value of  $H$  from the  $B$ - $H$  curve.

make no allowance for the flux lines which pass from the sides of the tooth into the iron at the bottom of the slot, thus causing the actual density at the narrowest part of the tooth to be something less than the calculated value.

The previously estimated depth of 5 in. for the rotor slot seems rather large, as it leaves hardly sufficient section of iron at the root of the tooth. We shall therefore reduce this depth to  $4\frac{3}{4}$  in. as dimensioned in Fig. 135. The width of the tooth at the bottom is therefore  $\frac{\pi(38.25 - 9.5)}{32} - 1.625 = 1.2$  in.

If a larger section of iron should be found necessary, it can be obtained by reducing the size of the slots at the center of the pole face (*i.e.*, those which carry no field coils); but this question can be settled later.

The curve marked "air gap, teeth, and slots" in Fig. 139, shows what excitation is required to produce a particular density in the air gap. The departure from the air-gap line (the dotted straight line) is due almost entirely to saturation of the rotor teeth, the reluctance of the stator teeth being negligible as compared with that of the  $1\frac{1}{4}$ -in. air path.

*Items (50) and (51).*—The upper curve of Fig. 140 shows the ideal flux-distribution curve for open-circuit conditions. It is a sine curve of which the average ordinate is

$$B_a = \frac{62.2 \times 10^6}{6.45 \times 31.416 \times 51} = 6,010$$

and of which the maximum value is therefore  $\frac{\pi}{2} \times 6,010 = 9,450$  gauss. The area of this curve is a measure of the total air-gap flux on open circuit (item (17)). The pole pitch—represented by 180 electrical degrees—has been divided into eight parts, and the height of the vertical lines is a measure of the flux density in the air gap over the center of a rotor tooth.

By providing a datum line and vertical scale of ampere-turns immediately below the no-load flux curve, it becomes a simple matter to plot an ideal curve of m.m.f. distribution over the pole pitch, the shape of this curve being such as to produce the desired flux distribution (see Art. 93, Chap. XIII). It is merely necessary to read off the curve of Fig. 139 the ampere-turns corresponding to the required air-gap density and to plot this over the center of the corresponding tooth. In this manner the lower curve of Fig. 140 is obtained. The practical approxi-

mation to this ideal m.m.f. distribution would be the arrangement shown by the stepped curve, with 9,000 ampere-conductors in each slot. This would produce a flat-topped flux-distribution curve, a condition which might be remedied by putting 5,000 ampere-turns in the empty slots at the center of the pole face;

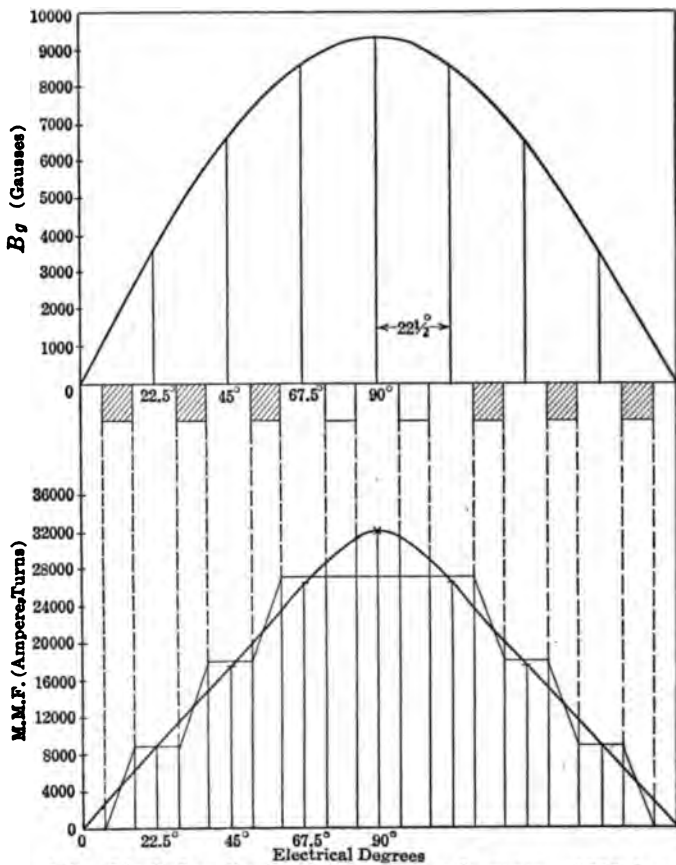

FIG. 140.—Ideal flux-distribution and m.m.f. curves—8000 k.v.a. turbo-alternator.

but such a procedure would be very uneconomical and unsatisfactory. The best thing to do will be to increase the permeance of the center tooth, either by reducing the width of the two slots on each side of the center tooth, or by partly filling up these slots with iron wedges so shaped as to produce the effect of a tooth with parallel sides. These slots should, in any case, be



filled with material equal in weight to the copper and insulation in the wound slots, in order to improve the balance and equalize the stresses at high speeds; and the proportion of magnetic to non-magnetic metal can be so adjusted as to obtain any desired tooth reluctance. If we provide wedges having a thickness of  $\frac{1}{2}$  in. at the bottom of the slot, we can get the equivalent of a center tooth 2.2 in. wide with parallel sides. This calls for an additional curve in Fig. 139, which can be calculated in the same manner as the curve previously drawn, except that the correction for taper of teeth (SIMPSON'S rule) has not to be applied.

If we decide upon a rotor winding with 9,000 ampere-con-

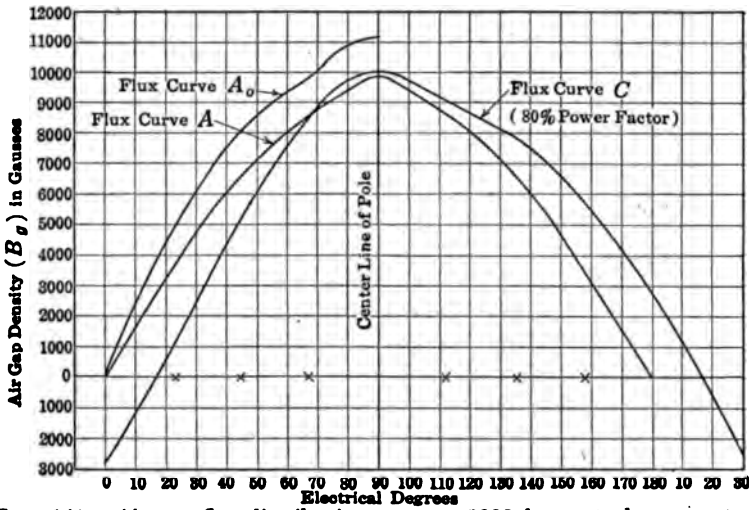

Fig. 141.—Air-gap flux-distribution curves—8000 k.v.a. turbo-generator.

ductors per slot as indicated by the stepped curve in the lower part of Fig. 140, we shall obtain an open-circuit flux curve (A) as plotted in Fig. 141. This curve would be exactly similar in shape to the flux curve of Fig. 140 if it were not for the fact that the widening of the tooth at the center of the rotor pole face has lowered the reluctance at this point rather more than would have been necessary in order to obtain the perfect sine curve of flux distribution. The slightly higher ordinate at the center of the new flux curve adds so little to the area of this curve that we shall not trouble to measure this. It is evident that the proposed excitation with 9,000 ampere-conductors per slot will generate the required open-circuit voltage.

The m.m.f. curve for flux curve *A* has been re-drawn in Fig. 142, the stepped curve being replaced by a smooth curve. In this connection it should be noted that the "fringing" of flux at the tooth tops tends to round off the sharp corners of the flux-distribution curves, and so justifies the use of smooth curves in any graphical method of study. At the same time, it will generally be possible to detect in oscillograph records of the e.m.f. waves the irregularities or "ripples" due to the tufting of the flux at the tooth tops; but these minor effects will not be considered, either here or later when calculating the form factor of the e.m.f. wave.

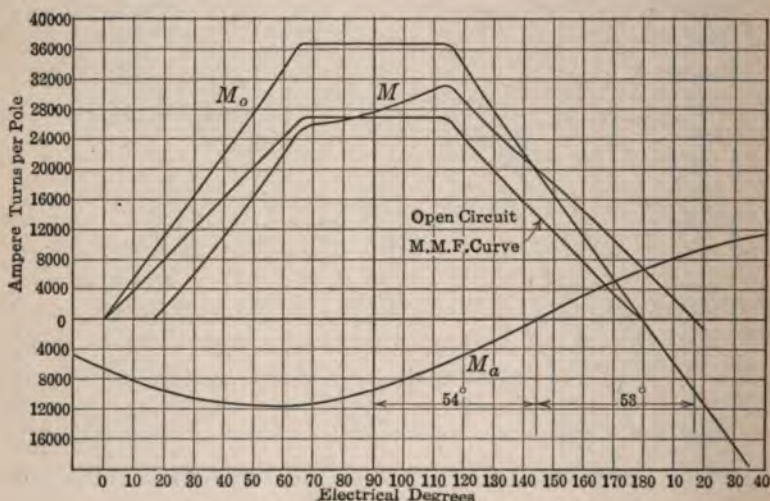

FIG. 142.—M.m.f. curves for 8000 k.v.a. turbo-generator.

Items (52) to (54).—The area of the flux curve *A* of Fig. 141, on the assumption that it is a true sine curve similar to the one of Fig. 140, and on the basis of unit squares with sides equal to 1 cm., is  $5.91 \times 18 = 106.3$  sq. cm., where 5.91 is the average density in kilogausses (item (18)). The required area of the full-load flux curve *C*, at the specified power factor of 0.8, is therefore  $106.3 \times \frac{4,000}{3,810} = 112$ , where the figure 4,000 is the length of the vector  $OE'_o$  of Fig. 137, as calculated under item (40), and the figure 3,810 is the open-circuit star voltage (vector  $OE_t$ ).

In order to determine the field excitation necessary to provide the required flux with full-load current taken from the machine

on a power factor of 0.8, it is necessary to know the maximum armature m.m.f. and also the position on the armature surface (considered relatively to the field poles) at which this maximum occurs. It was shown in Art. 94, Chap. XIII, that the armature m.m.f. can be represented by a sine curve of which the maximum value (by formula (100)) is

$$(SI)_a = \frac{48 \times 3 \times 700 \times \sqrt{2}}{\pi \times 4} = 11,340 \text{ ampere-turns per pole.}$$

The displacement of this m.m.f. curve relatively to the center of the pole is obtained approximately by calculating the angle  $\beta$  as explained in Art. 98. The vectors representing the component m.m.f.s. have been drawn in Fig. 137, the angle  $\psi'$  being calculated from the previously ascertained values of the voltage vectors (see calculations under item (40)). Thus

$$\cos \psi' = \frac{(0.8 \times 3,800) + 8.4}{4,000} = 0.763$$

whence  $\psi' = 40^\circ 40'$ .

Since 27,000 ampere-turns per pole are required to develop 3,810 volts per phase, and since the saturation curve does not depart appreciably from a straight line, the m.m.f. vector  $OM$  to develop  $OE'_o$  (*i.e.*, 4,000 volts) must represent approximately  $\frac{27,000 \times 4,000}{3,810} = 28,400$  ampere-turns, and the required angle is,

$$\beta = \tan^{-1} \frac{CM_o}{OC}$$

where

$$CM_o = CM + MM_o = OM \sin \psi' + 11,340 = 29,740$$

and

$$OC = OM \cos \psi' = 21,650$$

The angle  $\beta$  is thus found to be  $53^\circ 57'$  or (say) 54 degrees.

The sine curve  $M_o$  representing armature m.m.f. can now be drawn in Fig. 142, with its maximum value displaced (54 + 90) degrees beyond the center of the pole. The required field ampere-turns are given approximately by the length of the vector  $OM_o$  (Fig. 137), except that the increased tooth saturation has not been taken into account. The length  $OM_o$  is  $\frac{OC}{\cos \beta} =$



$\frac{21,650}{0.588} = 36,800$ . An excitation slightly in excess of this amount will probably suffice,<sup>1</sup> because if the average density over the pole pitch is raised from 6,010 gaussess to  $6,010 \times \frac{4,000}{3,810} = 6,300$  gaussess, the average effect of increased tooth reluctance, as shown by Fig. 139, is small, and we shall try 37,000 ampere-turns on the field. This full-load field excitation is represented by the curve  $M_o$  of Fig. 142. Now add the ordinates of  $M_o$  and  $M_a$ , and obtain the resultant m.m.f. curve  $M$ . Using this new m.m.f. curve, we can obtain from Fig. 139 the corresponding values of air-gap flux density, and plot in Fig. 141 the full-load flux curve  $C$  of which the area, as measured by planimeter, is found to be 112.3 sq. cm. This checks closely with the calculated area (112 sq. cm.) and it follows that a field excitation of 37,000 ampere-turns will provide the right amount of flux to give the required terminal voltage when the machine is delivering its rated full-load current at 80 per cent. power factor.

*Items (55) to (57).*—When the shape of the flux curves of Fig. 141 is considered in connection with the fact that a distributed armature winding tends to smooth out irregularities in the resulting e.m.f. wave (see Fig. 118, page 293), it is evident that we need not expect any great departure from the ideal sine curve in the e.m.f. waves of this particular machine either on open circuit or at full load. At the same time it will be well to illustrate the procedure explained in Arts. 100, 101, and 102, by plotting the actual e.m.f. wave resulting from the full-load flux distribution curve,  $C$ , of Fig. 141.

The average flux density corresponding to any given position of the four slots constituting one phase-belt is obtained as explained in Art. 100, and the instantaneous values of the "apparent" developed e.m.f. are calculated by formula (107). The results of these calculations have been plotted in Fig. 143 to rectangular coördinates, and in Fig. 144 to polar coördinates. The mean ordinate of Fig. 143 is 3,610 volts, and the r.m.s., or virtual value of the e.m.f., is the square root of the ratio, *twice*

<sup>1</sup>This method of estimating the full-load field ampere turns is not scientifically sound, especially in the case of salient-pole machines, because the m.m.f. distribution over the armature surface, due to the field-pole excitation, is rarely sinusoidal as here assumed. The correct increase of field excitation to obtain a given full-load flux must, therefore, be obtained by trial; but the method here used indicates the approximate increase of excitation required.



area of the curve Fig. 144  $\div \pi$ , which is 3,975 volts. The form factor (Art. 101) is  $\frac{3,965}{3,605} = 1.10$ . It must not be forgotten that

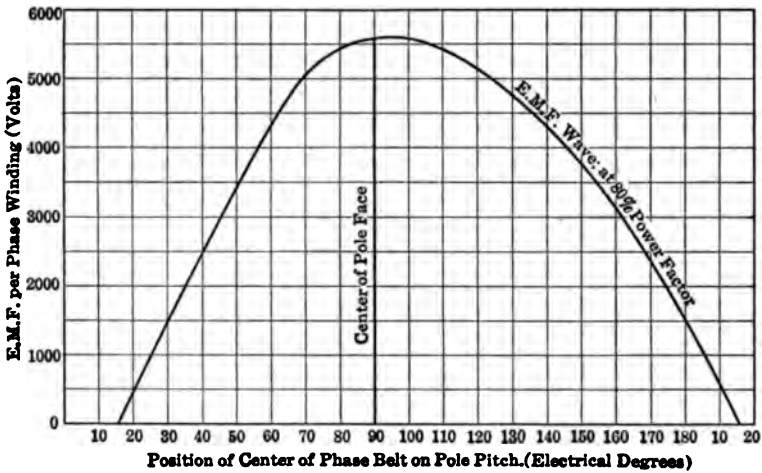

FIG. 143.—Wave-shape of e.m.f. developed in armature windings of 8000 k.v.a. turbo-generator on 80 per cent. power factor full-load output.

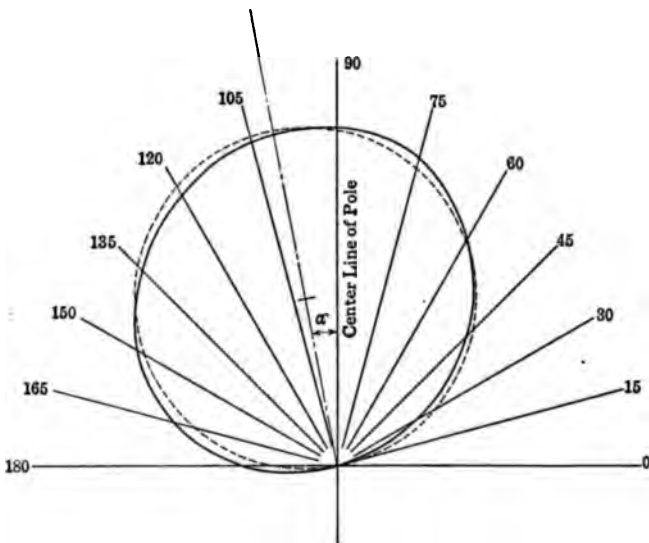

FIG. 144.—E.m.f. wave of Fig. 143 re-plotted to polar coordinates.

the machine under consideration is Y-connected, and the wave-shape of the potential difference between terminals will be

very closely represented by the addition of two curves similar to Fig. 143 with a phase displacement of 60 degrees, as pointed out on page 291.

As a check on the work, it should be noted that if the e.m.f. wave shape (Fig. 143) had been a true sine-wave, the virtual value of the apparent developed voltage would have been  $3,605 \times 1.11 = 4,000$ , which proves the accuracy of the graphical work. It is not, however, suggested that a difference of 1 per cent. in the form factor is a matter of practical importance; but in salient-

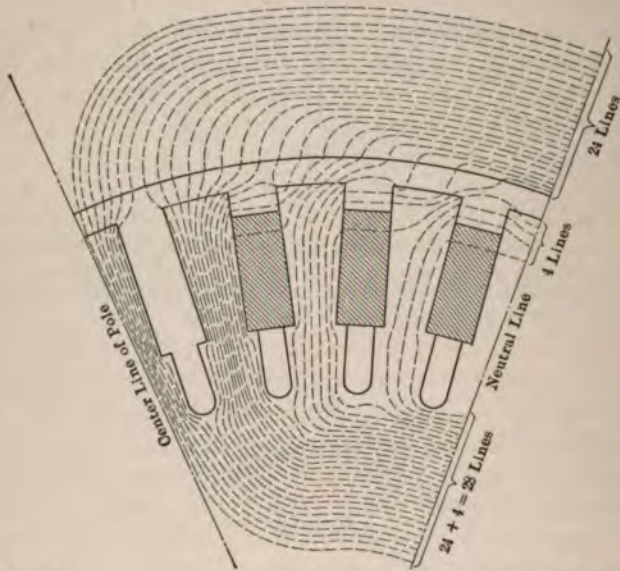

FIG. 145.—Diagrammatic representation of flux lines in turbo-alternator.

pole machines with incorrectly shaped pole faces and a concentrated armature winding, the wave shape may depart very considerably from the sine curve, and it is under such conditions that the methods here illustrated will be of the greatest value.

The area of one lobe (Fig. 144), using 1 volt as the unit radius vector, is 24,700,000, and the maximum ordinate of the equivalent sine-wave, as given by formula (108), is

$$d = \sqrt{\frac{4 \times 24,700,000}{\pi}} = 5,600 \text{ volts}$$

This is the diameter of the equivalent circle in Fig. 144, and the angle  $\alpha$ , obtained as explained in Art. 102, is found to be 11 degrees.

It is obvious that the wave shape under no-load conditions will be very nearly a true sine-wave, and the form factor will therefore be approximately 1.11.

*Item (59).*—No reference has been made to item (58) because this applies mainly to the salient-pole type of machine; the procedure in proportioning the field poles and yoke ring being then similar to that followed in D.C. design. The depth of iron below the slots in the rotor of a turbo-alternator is usually more than sufficient to carry the flux, including the leakage lines. In the particular design under consideration we shall be able to provide air ducts at the bottom of the rotor slots as shown in Figs. 135 and 145, and still leave enough section of iron to carry the flux.

The amount of the leakage flux at the two ends of the rotor is not easily estimated; but when expressed as a percentage of the useful flux it is never large in extra high-speed machines with wide pole pitch; the greater the axial length of rotor in respect to the diameter, the smaller will be the percentage of the flux leaking from pole to pole at the ends. The rotor leakage which occurs from tooth to tooth, and in the air gap, over the whole length of the machine is shown diagrammatically in Fig. 145. This sketch shows a total of four lines of leakage flux which pass through the body of the rotor, but do not enter the armature. This leakage flux will not appreciably affect the flux density in the rotor teeth near the neutral zone, because it will follow the path of least reluctance and be distributed between several teeth.

The calculation of the rotor slot flux may be carried out as for the stator windings. Thus, at full load, with 12,300 ampere-conductors per slot, the flux passing from tooth to tooth below the wedge is

$$\underbrace{\frac{0.4\pi \times 12,300}{2}}_{\text{Average } m.m.f.} \times \underbrace{\frac{(3.5 \times 49.5) \times 2.54}{1.625}}_{\text{Permeance}} = 2,100,000 \text{ maxwells.}$$

The flux in the space occupied by the wedge and insulation above the copper, including an allowance for the spreading of the



flux lines into the air gap above the wedge (tooth top leakage), is approximately,

$$0.4\pi \times 12,300 \times \frac{(1.75 \times 49.5) \times 2.54}{1.8} = 1,900,000 \text{ maxwells,}$$

where the figure 1.75 is the assumed radial depth, in inches, of the flux path, and 1.8 is the assumed average length of the flux lines (somewhat greater than the width of slot below the wedge).

The sum of the two flux components is 4,000,000 maxwells, making the total slot flux for both sides of the pole face equal to twice this amount, or 8,000,000 maxwells. As a rough estimate, we may assume the end leakage to be about one-sixth of this, making a total of 9,300,000 maxwells. The full-load leakage coefficient is therefore  $\frac{65.2 + 9.3}{65.2} = 1.142$  or (say) 1.15.

The maximum number of flux lines in the rotor, which cross the section below the slots (represented by 28 lines in Fig. 145) is

$$\frac{65,200,000}{2} \times 1.15 = 37,500,000$$

The cross-section of iron below the vent ducts is  $12\frac{1}{8} \times 49\frac{1}{2} = 600$  sq. in.; which makes the average flux density 62,500 lines per square inch. The section of iron below the slots is therefore sufficient, and the reluctance of the body of the rotor is a negligible quantity in comparison with that of the teeth and air gap.

*Items (62) to (68).*—With a density of 8,500 gausses in the stator core (item 28), and ample iron section in the rotor, the additional ampere-turns required to overcome reluctance of armature and field cores will probably not exceed 200; and since this is a very small percentage of the excitation for air gap and teeth, we shall not need to draw a new curve for item (62): the curves of Fig. 139 may be thought of as applying to the machine as a whole. The ampere-turns at no load and at full load (items 63 and 64) will therefore be taken at 27,000 and 37,000 respectively, as previously calculated.

The slot insulation should be about  $\frac{1}{8}$  in. thick, and the field winding might be in the form of copper strip  $1\frac{1}{4}$  in. wide laid flat in the slot. Allowing  $\frac{3}{4}$  in. total depth of insulation—preferably of mica or asbestos fabric—between the layers of the winding, the cross-section of copper will be  $2\frac{7}{8} \times 1\frac{1}{4} = 3.6$  in. making the current density at full load,  $\Delta = \frac{12,300}{3.6} = 3,430$



amp. per square inch. This is a high, but not necessarily an impossible figure.

The mean length per turn of the rotor winding should be measured off a drawing showing the method of bending and securing the end connections. We shall assume this length to be 156 in. All the turns will be in series, and the mean length per turn for the four poles in series will be  $156 \times 4 = 624$  in. Assuming the potential difference at the slip rings to be 120 volts, the cross-section of the winding, by formula (26), is

$$(m) = \frac{624 \times 37,000}{120} = 192,500 \text{ or } 0.1512 \text{ sq. in.}$$

If we use a copper strip 0.12 in. thick, the number of conductors in each slot will be  $\frac{2.875}{0.12} = 24$ , making the turns per pole  $24 \times 3 = 72$ .

The current per conductor at full load must be  $\frac{37,000}{72} = 514$  amp., whence the current density is  $\Delta = \frac{514}{1.25 \times 0.12} = 3,430$  amp. per square inch.

The total length of copper strip is  $\frac{72 \times 4 \times 156}{12} = 3,740$  ft.

The resistance (hot) will be about 0.250 ohm, and the required pressure at slip rings will be  $0.25 \times 514 = 128.5$  volts. The  $I^2R$  loss is therefore  $128.5 \times 514 = 66$  kw., or 0.825 per cent. of the rated output. This is rather on the high side for so large a machine, and it may be accounted for by the fact that the air gap is perhaps somewhat greater than it need be; but the efficiency will not be affected appreciably.

*Item (69).*—The cooling air, which enters at one end of the machine, is supposed to travel through the longitudinal vent ducts to the other end of the machine, no radial ducts being provided. Such an arrangement leads to the temperature of one end of the machine being higher than the other end; but systems of ventilation designed to obviate this are usually less simple, and the straight-through arrangement of ducts has much to recommend it. In machines larger than the one under consideration, it might be necessary to have the cold air enter at both ends, in which case one or more radial outlets would be provided at the center.

In addition to the ducts of which mention has already been

made, we may provide a number of spaces between the stator iron and the casing to allow of air being passed over the outside of the armature core. Let us suppose that there are twelve such ducts, each 10 in. wide by 1 in. deep; the total cross-section of the air ducts is then made up as follows:

Outside stator stampings.....	$12 \times 10 \times 1 = 120$ sq. in.
Holes punched in stator stampings (Fig. 136).....	= 590
Spaces above wedge in stator slots (Fig. 135)	
	$48 \times 1.5 \times 1 = 72$
Clearance between stator and rotor $\frac{7}{8} \times \pi \times 39\frac{1}{8} = 108$	
Spaces in rotor forging below slots.....	$32 \times 1.94 = 62$
	—
Total.....	= 952 sq. in.

or 6.6 sq. ft.

The total losses in the machine, without including windage and sundry small losses, are

Total core loss (item (32)).....	120 kw.
Stator $I^2R$ loss (item (36)).....	21 kw.
Rotor $I^2R$ loss.....	66 kw.
	—
Total.....	207 kw.

If we allow 100 cu. ft. of air per minute for each kilowatt dissipated (see Art. 33, Chap. VI), it will be necessary to pass 20,700 cu. ft. of air through the machine per minute. This makes the velocity in the vent ducts  $\frac{20,700}{6.6} = 3,140$  ft. per minute, which is well below the permissible limit.

*Item (70).*—With varying degrees of tooth saturation—especially when, as in this design, all the teeth are not of the same cross-section—the only correct method of predetermining the open-circuit saturation curve (similar to Fig. 124, Art. 104), is to plot the flux distribution for different values of the exciting ampere-turns, and calculate the e.m.f. developed in each case. It is not necessary to calculate a large number of values in this manner; two or three points taken with fairly high values of the exciting current will show how the tooth saturation affects the resulting flux; and a curve can be drawn connecting the known straight part of the saturation curve with these ascertained values for the higher densities.

The saturation curve for zero power factor can be drawn as explained in Art. 106 (Fig. 125), and the construction of Figs.

129 and 130 can be applied for obtaining curves giving the approximate connection between terminal volts and exciting current for any other power factor. We shall confine ourselves here to calculating the inherent regulation by the more correct method as outlined in Art. 110, and since much of the work has already been done in connection with full-load current on 80 per cent. power factor, this is the condition which we shall choose for the purpose of illustration.

We know that although 27,000 ampere-turns per pole will develop the specified terminal voltage when no current is taken from the machine, this excitation must be increased to 37,000 ampere-turns to give the same terminal voltage under full-load conditions (80 per cent. power factor). If then, we can calculate the voltage, with this greater field excitation, when the load is thrown off, the inherent regulation can be predetermined, and, incidentally, we shall obtain a point on the open-circuit characteristic corresponding to a fairly high value of the excitation.

The required flux curve, marked  $A_o$ , has been plotted in Fig. 141. It is derived, like any other flux curve, from the m.m.f. curve  $M_o$  of Fig. 142, by using the saturation curves of Fig. 139—which must be extended beyond the limits of the diagram in order to read the flux values for the higher degrees of excitation. Careful measurements of the flux curve  $A_o$  give an area over the pole pitch of 129 sq. cm., and if we assume the form factor of the resulting e.m.f. wave (not plotted) to be the same as for the open-circuit curve at normal voltage, *i.e.*, 1.11, the voltage corresponding to the flux  $A_o$  will be

$$\frac{3,810 \times 129}{106.3} = 4,625$$

where 106.3 is the previously measured area of flux curve  $A$ . The inherent regulation at 80 per cent. power factor is therefore

$$\frac{4,625 - 3,810}{3,810} = 21.4 \text{ per cent.}$$

This is well within the specified limit of 25 per cent. which again points to the fact that a somewhat smaller air gap, or a lower flux density in the rotor teeth would have been permissible.

It should be pointed out here that the external power factor corresponding to the flux distribution curve  $C$  of Fig. 141 is not necessarily exactly 0.8; because the method of determining the



angle  $\beta = 54$  degrees (Figs. 137 and 142) was based on certain conditions that may not actually be fulfilled. A closer determination of the external power factor corresponding to the conditions that have been studied is easily made as follows.

The angle  $\alpha$  of Fig. 137 was determined on page 349 and found to be 11 degrees. The angle  $\psi'$  is therefore  $\beta - \alpha = 54 - 11 = 43$  degrees, instead of the previously obtained value of  $40^\circ 40'$  (see calculations under items (52) to (54)). The vector  $OE'_o$  is known, and its value is 4,000 volts, since this is the e.m.f. developed by the flux distribution  $C$  of Fig. 141. In order to obtain the corrected values for the angle  $\theta$  and the length of the vector  $OE_t$  in Fig. 137, we have:

$$OB = OE'_o \cos \psi' = 4,000 \cos 43^\circ = 2,925$$

whence  $OA = 2,917$

Also,  $BE'_o = OE'_o \sin \psi' = 4,000 \sin 43^\circ = 2,725$

whence  $AE_t = 2,419$

Thus,  $\tan \theta = \frac{2,419}{2,917} = 0.83$ , which corresponds to  $\theta = 39^\circ 40'$ .

The external power factor is therefore  $\cos \theta = 0.77$  and the terminal voltage  $= \sqrt{3} \frac{OA}{\cos \theta} = \frac{\sqrt{3} \times 2,917}{0.77} = 6,570$ .

Thus, the condition that has actually been worked out by graphical methods corresponds to a terminal voltage of 6,570 with full-load current on an external power factor of 0.77. This is sufficiently close to the specified condition with figures 6,600 and 0.8 to show that the machine will comply with the requirements.

Applying these corrections to the regulation, we have:

$$\left. \begin{array}{l} \text{Inherent regulation with full-load current} \\ \text{on an external power factor of 0.77} \end{array} \right\} = \frac{\sqrt{3} \times 4625 - 6570}{6570} = 22 \text{ per cent.}$$

*Item (71).*—On the assumption that the inductance of the armature windings can be correctly calculated, the short-circuit current corresponding to any given field excitation can readily be determined by the method described in Art. 107. The curve marked *volts* in Fig. 146 is the open-circuit characteristic of the machine, the scale of ordinates being on the left-hand side of the diagram. The construction shows that, in order to develop the



flux necessary to produce full-load current (700 amp.) in the short-circuited windings, 1,900 ampere-turns per pole are required. This is the excitation which will develop an "apparent" e.m.f. equal to the sum of items (37) and (38); the effect of the *IR* drop being negligible. The armature m.m.f. is almost directly demagnetizing, and the ampere-turns per pole must, therefore, be  $1,900 + 11,340 = 13,240$ . The current curve, within the range of the diagram, will be a straight line, and with the full-load excitation of 37,000 ampere-turns, the short-circuit current will be 1,950 amp., or 2.8 times normal. This is the steady value which the short-circuit current would attain if the field excitation were gradually brought up to full-load value; but at the instant of the occurrence of a short-circuit with full-load excitation, the current

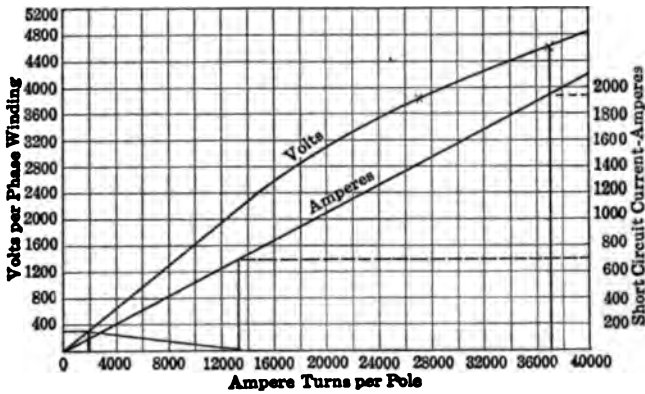

FIG. 146.—Curves of open-circuit voltage and short-circuit current—8000 k.v.a. turbo-generator.

would be limited only by the impedance of the stator windings which must set up a flux of self-induction equal to the total flux. If we neglect the effect of iron saturation and the changes in the paths of the flux leakage lines, the momentary current might be  $700 \times \frac{4,000}{306} = 9,150$  amp., or 13 times normal-load current.

It might even be greater than this, depending upon the instantaneous value of the generated e.m.f. when the short-circuit occurs, and the windings should be arranged if possible to withstand without injury the mechanical forces exerted on the coils under this condition. If this cannot be done, reactance coils external to the machine must be provided; but the tendency to-day is to design machines, even of the largest sizes, with suffi-

cient internal magnetic leakage to prevent mechanical injury due to excessive magnetic forces on short-circuit.

*Items (72) and (73).*—Seeing that the calculation of efficiency under different conditions of loading was illustrated in Art. 63 when working out the example in dynamo design, it will not be necessary to cover the same ground a second time. We shall, therefore, determine the full-load efficiency only (item (73)).

The windage and bearing friction loss is very difficult to estimate; but some approximate figures were given in Art. 111. We shall assume 1.1 per cent. of the total k.v.a. output for the loss due (mainly) to the friction of the air passing through the axial ducts, and also to friction in the outside bearing. It is assumed that the losses in the bearing on the side of the prime mover are included in the steam-turbine efficiency. The power necessary to drive the blower is not included in the above estimate of the windage and friction loss.

For the correct calculation of iron losses, the reader is referred to Art. 60, Chap. IX where the method of determining the tooth losses was explained; but since the maximum tooth density under full-load conditions, as indicated by curve *C* of Fig. 141 does not differ appreciably from the maximum of the open-circuit curve (*A*), we shall not trouble to correct the tooth losses as previously calculated.

With reference to the iron in the body of the stator, the flux indicated by the area of the load flux curve *C* of Fig. 141 does not all enter the core below the slots, because this total flux includes the slot-leakage flux, as explained in Art. 95. The position of the conductors carrying the maximum current coincides with the zero point on the armature m.m.f. curve. This is the position 17 degrees in Figs. 141 and 142; and the current in the conductor will be approximately  $700 \times \cos 53^\circ = 420$  amp. The slot-leakage flux corresponding to this particular current—the *total* not the “equivalent” flux—can be calculated as explained in Art. 96, Chap. XIII, when deriving formula (104) which, however, gives the “equivalent” and not the total slot leakage flux. If  $\Phi_s$  is the calculated slot flux, and  $\Phi$  is the total flux per pole in the air gap, then the flux actually carried by the section of the armature iron below the slots is  $\frac{\Phi}{2} - \Phi_s$ . This correction is a refinement which need not be applied in the case of a turbo-alternator, in which the pole pitch is always large, causing  $\Phi_s$

to be small in relation to  $\Phi$ ; but in machines with a small pole pitch—especially if there is only one slot per pole per phase—the correction should be made.

The full-load flux per pole is  $65.2 \times 10^6$  maxwells (item (40)), as against  $62.2 \times 10^6$  (item (17)) on open circuit. With the increase of flux density, the loss per pound of iron will be about 3.5 instead of 3.2 watts, and the full-load iron loss will, therefore, be  $0.3 \times 28,000 = 8.4$  kw. more than on open circuit; thus bringing the total iron loss up to (say) 130 kw.

The loss at the slip rings may be calculated by the approximate formula given in Art. 111. The diameter of the slip rings will probably not be less than 15 in., so that the rubbing velocity will be  $\frac{\pi \times 15}{12} \times 1,800 = 7,100$  ft. per minute. The contact area of the two sets of brushes (to carry 514 amp.) might be 5 sq. in., making the loss from this cause  $\frac{7,100 \times 5}{100} = 355$  watts, which is negligible in comparison with the other losses.

Adding up the separate losses, we have:

Windage and friction.....	88 kw.
Stator iron.....	130 kw.
Stator copper.....	21 kw.
Rotor copper.....	66 kw.
Total.....	305 kw.

The kw. output is  $0.8 \times 8,000 = 6,400$  and the efficiency, excluding losses in exciter and in air blower external to the generator, is therefore  $\frac{6,400}{6,400 + 305} = 0.955$ .

*Items (74) and (75).*—On the basis of 290 kw. to be carried away by the circulating air with a mean increase of temperature of about 20°C., the quantity of air required will be 29,000 cu. ft. per minute. The cross-section of the ducts (item (69)) is 6.6 sq. ft., and the average velocity in the ducts (item (75)) is, therefore,  $\frac{29,000}{6.6} = 4,400$  ft. per minute.

In the design of large generators there are many matters of detail to be considered which have received but little attention here. The question of temperature rise, for instance, is one that would receive more attention from the practical designer than we have given it here. It is usually permissible to assume that, if the difference in temperature between ingoing and outgoing air

is 20°C., the actual temperature rise of the heated surfaces as measured by thermometer, will not exceed 40° to 50°C.; but, unless every part of the machine is carefully designed, excessive local heating may result. The temperature of the copper in the slots might ordinarily be from 15° to 25°C. higher than that of the iron from which it is separated by layers of insulating material; but should this insulation be very thick, and the cooling ducts of insufficient section or improperly located, very much higher internal temperatures may be reached.



## INDEX

### A

- Acyclic D. C. generators, reference to, 83  
 Air-gap, density (*see* Flux density).  
     "equivalent," 117, 212, 337  
     length of, 119, 252, 325, 337  
     permeance, 116, 272, 336  
 Alternator, design sheets for 8,000 k.v.a., 322  
     three phase, output of, 247  
 Alternators, classification of, 238  
     single-phase, 280, 321  
 Amortisseur windings (*see* Pole-face windings).  
 Ampere-conductors per inch (*see* Specific loading).  
 Ampere-turns, calculation of, on horseshoe magnet, 60  
     in dynamo field coils, 139, 187  
     in series winding (dynamo), 190  
     on armature (of dynamo), 78, 136 (of alternator), 249, 278, 345  
     on interpoles, calculation of, 174  
     per unit length in air, 21  
 "Apparent" developed voltage (A.C.), 287, 334  
 Armature ampere-turns (*see* Ampere-turns).  
     coils, length of, 97, 261  
     conductors, current density in, 97, 259  
     insulation of (*see* Insulation).  
     losses in, 318  
     number of, 206  
     core, flux densities in, 104, 210, 266, 330  
     losses in, 100, 104, 266, 331, 356  
     net and gross length of, 103, 326  
     current, effect of, on flux distribution, 135  
     diameter (how determined), 77, 205  
     Armature, m.m.f., 136, 274, 278  
         in single-phase alternators, 280  
         reactance and reaction, 304  
         teeth (*see* Teeth).  
     windings, concentrated (A.C.), 242  
         distributed (A.C.), 242  
         double layer (A.C.), 255  
         duplex, 86  
         full pitch, 85  
         inductance of, 263  
         insulation of (*see* Insulation).  
         losses in, 99  
         multiple or lap, 86  
         multiplex, 86  
         resistance of, 97, 209, 260  
         series or wave, 86  
         short pitch (chorded), 85, 160  
         simplex, 86  
         single layer (A.C.), 255  
         single-, two-, and three-phase, 240  
         spread of (A.C.), 257; in single phase, 258  
     Armatures, drum-wound, 84  
         ring-wound, 84  
         temperature rise of, 107, 111, 267  
         ventilation of, 105, 261, 351  
 ARNOLD, DR. E., referred to, 141  
 Asynchronous A.C. generators referred to, 237  

### B

 Balancing coils (*see* Pole-face windings).  
 BEHREND, B. A., referred to, 307  
 B-H curves, 16, 17, 18, 215  
 Brown and Sharp gage, 34, 36  
 Brush contact resistance, 179, 226  
     effect of, on commutation, 147, 175  
     pressure, usual, 179  
     width, as affecting commutation, 157, 162

Brush, width, usual limits, 178  
 Brushes, current density at contact surface of, 178, 180  
 friction losses at, 182, 227, 318  
 I<sup>2</sup>R losses at, 181

## C

Calorie, definition of, 47  
 CARTER, F. W., referred to, 116  
 Chorded armature windings, 85, 160  
 Circular lifting magnet, design of, 64  
 mils, definition 35, conversion factor, 36  
 per ampere, conversion factor, 41  
 CLAYTON, A. E., referred to, 309  
 Clutch, magnetic, 50  
 Coefficient (*see* Cooling, Friction, Leakage, coefficient).  
 Commutating poles (*see* Interpoles).  
 Commutation, effect of brush resistance on, 147, 175  
 of end flux on, 151  
 of field distortion on, 169  
 of slot leakage on, 149  
 ideal, or "straight line," 148  
 mechanical details affecting, 178  
 selective, 88  
 sparking limits, 175  
 theory of, 142  
 time of, 140, 162  
 Commutator, 180, 184  
 diameter of, 181  
 peripheral velocity of, 184  
 segments, number of, 90, 93, 223  
 volts between, 94  
 temperature rise of, 181  
 Compensating windings (*see* Pole-face windings).  
 Concentrated windings (*see* Armature windings).  
 Conductors (*see* Armature conductors).  
 Conical pole faces, magnets with, 31  
 Cooling coefficient (magnet coils), 45  
 (dynamo field coils), 194  
 of armatures, etc. (*see* Temperature rise).

Copper wire, properties of, 33  
 resistance of, 36  
 tables, 34, 35, 38  
 weight of, 36, 47  
 Core (*see* Armature core).  
 Cost, important factor in design, 6  
 of electromagnets, 49, 69  
 Critical speed of rotor, 327  
 Cultural subjects, value of study of, 8  
 Current density at brush contact surface, 178, 180  
 in armature conductors, 96, 259, 328  
 in coils of horseshoe magnet, 56  
 usual, in magnet windings, 41

## D

Damping grids (*see* Pole-face windings).  
 "Dead" coils in armature windings, 90  
 Density (*see* Flux, Current, density).  
 Distributed armature windings (*see* Armature).  
 field windings, 270, 335  
 Distribution factor, 243  
 Diverter, 193, 233, for interpoles, 168  
 Dynamo, design sheets for 75 kw., 201  
 $\Delta$ -connection, 244

## E

Eddy-current losses (*see* Losses).  
 Efficiency of dynamo, 195, 197, 233  
 of alternator, 317, 357  
 Electromagnets, circular type, 64  
 cost of, 49, 69  
 design of, 48, 53  
 short stroke plunger type, 64  
 E.m.f. (*see* also Voltage).  
 developed in alternator armatures, 242, 261, 291  
 in dynamo armatures, 72, 138  
 by cutting of end flux (commutation), 159

- E.m.f., instantaneous value of developed (alternator), 293  
 virtual, or effective, value of, 294, 346  
 wave form, 291, 346
- Empirical formulas, impossible to avoid, 3
- Enamelled wires, 38
- End connections (armature), length of, 98
- End flux cut by commutated coil, 155
- English language, importance of thorough knowledge of, 5
- Equalizing connections for dynamos, 90
- Equivalent sine waves, 295, 348  
 slot flux, 161, 164, 285
- ESTERLINE, PROF. J. W., referred to, 101
- Excitation (*see* Ampere-turns).
- Exciting current, usual values of (dynamos), 192
- F
- Face conductors (definition), 72 (*see* also Armature conductors).
- Factor of safety, calculation of, in magnet design, 63
- Fans, power required to drive ventilating, 107, 318
- FIELD, PROF. A. B., referred to, 319
- Field distortion in relation to commutation, 169  
 magnet design, 185, 228, 299  
 with distributed windings, 270, 272, 335  
 rheostat, 191  
 windings, design of, 191, 231, 299, 351
- FLEMING AND JOHNSON, referred to, 192
- Flux density (definition), 13  
 in air gap of alternators, 251, 325  
 of dynamos, 75, 132  
 of magnets, 50, 54, 63, 65  
 in armature cores, 104, 210, 266, 330
- Flux density in armature teeth, 102, 104, 119, 122, 197, 209, 214, 251, 266  
 in commutating zone, 165, 167, 224  
 in pole core, 213  
 in rotor teeth, 335
- distribution, effect of armature current on, 135  
 effect of neighboring poles on, 126, 130  
 effect of tooth saturation on, 132  
 over armature surface, 124, 129, 213, 221, 342  
 leakage (*see* Leakage).
- Form factor, 294
- Frequency of alternators, 238  
 of D.C. dynamos, 78
- Friction coefficient (between metals), 52  
 of brushes, 182  
 losses (alternators), 317  
 (brushes), 181, 227, 318  
 (dynamos), 196.
- G
- Gauss (definition), 13
- Generator (*see* Alternator; dynamo).
- Gilbert, 11; definition, 12
- GRAY, PROF. A., referred to, 309
- H
- HAWKINS AND WALLIS, referred to, 99
- HAY, DR. A., referred to, 116, 132
- Heating coefficient (*see* Cooling coefficient).  
 intermittent, of magnet coils, 46  
 of armatures, coils, etc. (*see* Temperature rise).
- HELE-SHAW, H. S., referred to, 116
- HOBART AND PUNGA, referred to, 307
- Homopolar machines (reference only), 83
- Horsepower transmitted by magnetic clutch, 52
- Horseshoe lifting magnet, design of 53

- Hysteresis losses in armature stampings, 102  
teeth, 196
- I
- Imagination, value of, to the designer, 7
- Inclined surfaces, effect of, on magnetic pull, 30
- Inductance of A.C. armature windings, 263, 288  
of armature end connections, 304  
of slot windings (turbo-alternator), 329
- Inductor (definition), 72 (*see also* Armature conductors).
- Inherent regulation (definition), 252 (*see also* Regulation).
- Insulating materials, 37, 95
- Insulation, breakdown voltages, 40  
of armatures, 91, 96, 207, 258, 329  
maximum allowable temperatures for, 108  
thickness of, on magnet spools, 41
- Intensity of magnetic field (definition), 12
- Intermittent heating of magnet coils, 46
- Interpole design (numerical example), 171
- Interpoles, 165, advantages of, 169  
calculation of ampere-turns required on, 174
- K
- KAPP, DR. G., referred to, 110
- L
- LAMME, B. G., referred to, 141
- Language, importance of thorough study of, 5
- Lap, or multiple, armature winding, 86
- Leakage factor (definition), 28  
in alternators, 300  
in dynamos, 187
- Leakage of commutating poles, 167, 174
- Leakage flux, 21  
effect of, in saturation underload, 305  
in armature slots, 149, 281  
calculation of, 160, 284  
in circular lifting magnet, 67  
in horseshoe magnet, 57  
in multipolar dynamo, 187  
in similar designs, 27  
in turbo-alternators, 349  
paths, permeance of, in air, 22
- LEHMANN, DR., referred to, 124
- Lifting magnets (*see* Electromagnets).
- LISTER, G. A., referred to, 46
- Losses at brush contact surface, 181, 182, 227, 318  
in armature conductors, 318  
stampings, 101, 104, 266, 331, 356  
teeth, 102, 196, 211, 233, 318, 331
- M
- McCORMICK, B. T., referred to, 307
- Magnetic circuit, 10; fundamental equation, 14  
of alternator, 299  
of dynamo, 185, 228  
circuits in parallel, 18  
clutch, design of, 50  
flux, 11; definition, 13  
force (H), definition of, 12  
leakage (*see* Leakage flux).  
pull (formulas), 29
- Magnetization curves for iron, 16, 17, 18, 215
- Magnetizing force (H), 12
- Magnetomotive force (m.m.f.), 11; definition, 12  
distribution of, over armature periphery, 128, 134, 342, 344
- Magnets (*see* Electromagnets).
- Magnet windings, calculation of, 41, 61, 66
- Materials used in magnets and dynamos, 32



- Maxwell, 11; definition, 13  
**MENGES**, C. L. R. E., referred to, 155  
 Mesh connection, 244  
 Mica, commutator, thickness of, 94, 177  
**MOORE**, PROF. C. R., referred to, 101, 132  
**MORDEY** flat coil alternator referred to, 239  
**MORTENSEN**, S. H., referred to, 307  
**MOSS**, E. W., referred to, 84  
 Motors, continuous current, 70, 235  
**MOULD**, J., referred to, 84  
 Multiple, or lap, winding, 86  
 Multiplex armature windings, 86
- N
- Neutral field, or zone (definition), 146, 283  
**NORGGERATH**, J. E., referred to, 84
- O
- Oersted (definition), 13  
 Open-circuit characteristic curve (*see* Saturation curve).  
 Output formula for D.C. dynamos, 73, 76  
   of three-phase generator, 247
- P
- PARSHALL AND HOBART**, referred to, 101  
**PELTON** water-wheel, referred to, 241  
 Peripheral loading (*see* Specific loading).  
   velocity of alternator rotors, 238  
   of commutators, 184  
   of dynamo armatures, 77  
 Permeability, 11, 15; definition, 13  
 Permeance, 11; definition, 13  
   between concentric cylinders, 26  
   flat surfaces, 24  
   parallel cylinders, 27  
   curve, 123, 130  
   of air gap (slotted armatures), 116, 272  
   of leakage paths (formulas), 23  
 Phases, number of, 239
- Plunger magnet, 49  
 Polar coördinates, use of, for plotting irregular waves, 294, 347  
 Pole arc, 74, 76, 204, 249  
 Pole-face windings, 170, 279, 322, 336  
 Pole, length of, 186, 227  
 Pole pitch (definition), 74; usual values, 80  
   factors determining width of, 78, 248  
 Pole shoes, 188, 269  
 Poles, number of, 80, 204, 241  
**POWELL**, P. H., referred to, 116  
 Pressure rise when switching off magnet coil, 33  
 Pressures, usual, in commercial designs, 33, 248  
 Properties of materials, 32  
 Pull exerted by magnets, 29, 50
- Q
- Quantity of air required with forced ventilation, 112  
 of electricity, 70
- R
- Reactance, armature, 304  
 coils, use of, 355  
 Reactive voltage drop (slots), 288; (ends), 266, 304, 332  
 Regulation, effect of flux distribution on, 311  
   inherent (definition), 252  
   of alternators, 252, 301, 312, 352  
   on any power factor, 309  
   on zero power factor, 305  
 Reluctance, magnetic, 11; definition, 13  
 Resistance of armature windings, 97  
   of copper wires, 36  
   variation of, with temperature, 36  
 Rheostat, shunt field, 191  
 Rise of pressure on switching-off coil, 33  
   of temperature (*see* Temperature rise).  
 Rotor of turbo-alternators, 270, 272, 335

## S

Saturation curve for alternator, 302, 306, 310, 340, 355  
for dynamo, 189, 190, 228

Self-induction, not different from other induction, 155

Series field winding, 190, 192, 231  
or wave, winding, 86

Short-circuit current of alternators, 252, 308, 354

Short pitch armature windings, 85, 160

Shunt winding—calculation (dynamos), 191, 231  
with two sizes of wire, 42

Simplex armature windings, 86

SIMPSON'S rule, 122, 217

Single-phase alternators, 280, 321

Size of wire, calculation of, in magnet coils, 41

Sketches, importance of neat, 4  
"Skull cracker," 64

Slot, dimensions of, in alternator, 259  
in dynamo, 92, 93, 207  
insulation (*see* Insulation of armatures).  
leakage flux, calculation of, 160, 284  
effect of, on commutation, 149  
"equivalent," 161, 164, 285  
in alternators, 281  
pitch (definition), 92

Slots, number of, 93, 260

Space factor (definition), 39;  
(values), 40

Sparking at brushes, prevention of, 175, 225

Specific heat, 47

Specific loading (definition), 74  
values for alternators, 250, 325  
for dynamos, 76

Speeds, usual (dynamos), 81; (alternators), 241

Star connection, 244

STEINMETZ, DR. C. P., referred to, 141

S.W.G. wire table, 35

Symbols, list of, xi  
use of, 2Synchronous A.C. generators (*see* Alternators).

## T

Teeth, dimensions of (dynamos), 92, 208; (alternators), 259  
flux density in, 104, 119, 122, 197, 209  
losses in, 102, 196, 211, 233, 318, 331  
number of, 93, 260  
strength of rotor, 336  
taper, losses in, 196  
m.m.f. calculations for, 122

Temperature, internal, of magnet coils, 45  
rise of alternator field coils, 300  
of armatures, 107, 112, 212, 267, 357  
of circular lifting magnets, 67  
of commutator, 181, 227  
of dynamo field coils, 193, 232  
of iron-clad coils, 46  
of magnet coils, 44, 47, 56, 62  
of totally enclosed motors, 236

Third harmonic, effect of Y and  $\Delta$  connections on, 246

THOMPSON-RYAN, referred to, 170

Three-phase generators (*see* Alternator).

Time, value of, in engineering work, 64

Tooth saturation (comparison D.C. and A.C.), 271

Tractive force (magnetic pull), 29  
of cylindrical short-stroke magnets, 50

Tube of induction, 14

Turbo-alternator, design sheets for 8,000 k.v.a., 322

Turbo-alternators, output of modern, 320  
(rotor construction), 270  
(usual speeds), 242, 320

- U
- Undercutting commutator mica, 181  
 UNDERHILL, C. R., referred to, 48  
 Units, conversion of centimeter to inch, 2
- V
- Vector diagrams of alternator:  
   For determining inherent regulation, 315  
   Of short-circuited armature, 308  
   On lagging power factor, 289, 290, 311, 334  
   On zero power factor, 287, 307  
 Velocity of air in cooling ducts, 268, 357  
   peripheral (*see* Peripheral velocity).  
 Ventilating fans, power necessary to drive, 107, 318  
 Ventilation of armatures, 105, 261, 351  
 Virtual values of irregular waves, 294, 346  
 Voltage (*see* also E.m.f.).  
   drop at brush contact, 179  
   generated by cutting flux, 71  
   rise when switching current off coil, 33  
   usual, of A.C. generators, 248  
   Voltages to be considered in connection with insulation problems, 33
- W
- WADDELL, DR. J. A. L., referred to, 5  
 WALKER, PROF. M., referred to, 107, 255  
 Wave form (*see* E.m.f. wave form).  
 Wave winding (dynamoes), 86  
 Wedge for rotor slots, 336  
 Whirling speed of rotors, 326  
 Windage, loss due to, 196, 317, 356  
 Winding, depth of, to give required excitation, 43  
   on magnet limbs, 55  
   shunt coils with two sizes of wire, 43  
 Windings (*see* Armature field, magnet, windings).  
 Wire (*see* also Copper wire).  
   enamelled, 38  
   tables, 34, 35
- Y
- Y connection, 244  
 Yoke ring, dimensions of, 228







